

The Bluespot Collection





CONTENTS

04

Why Choose Bluespot?

- 05 Standards/Certificates
- 06 Swatches
- 07 Delivery

08

Desks



08 React - Height Adjustable 12 I10 Bench 15 R8 Bench 20 X5 Bench 25 X5 Cantilever 30 N6 Bench 33 A4 System



36 M3 System 39 B2 System 42 C3 Cantilever 45 C3 Panel

48

Accessories



48 Monitor Arm 49 CPU Holder 49 Powerport 49 Cable Slinky 49 Desk Cable Tray 49 Paper Tray 49 Pen Pot

50

Tables



50 Meeting 52 Flip Top 53 Folding 54 Height Settable 55 Welded

56

Universal Storage



56 Tray Units 59 Pedestals 62 Tambour Units 63 Storage Units 64 Combination Cupboards 65 Bookcases 66 Side Filing Cabinets 66 Filing Cabinets 67 Credenza Units 68 Storage Wall

69

Screens



70 Economy 71 Aluminium

72

Reception Desks



72 Colour Modular Reception Units 73 Modular Reception Units

WHY CHOOSE BLUESPOT?

FROM CONCEPT TO CREATION



Our impressive 35,000ft² manufacturing facility boasts the latest technology in panel processing. Continual investment has enabled Bluespot to offer the most complex of office furniture designs, manufactured to the highest quality standards at competitive prices. We invest in the latest technology to ensure that we can manufacture our products to the highest standard. We offer an industry-leading delivery lead-time of just 7 working days from placement of order – Guaranteed!

SHOWROOM, MARKETING AND SAMPLES



Our factory, warehouse and office complex also features a showroom, with our most popular products available to view. We can also welcome third party visitors should you need. We offer sample colour swatches free of charge and sample furniture for showrooms and pilot proposals are available at reduced prices (POA).

Bluespot support their dealer network with a huge collection of product images and scene shots for both web and print use, alongside marketing literature and videos which are available on request.

OUR STANDARDS



Our i10 range holds a lifetime structural guarantee.



Our products hold a manufacturer's warranty of 10 years.** This guarantee covers all defects in materials & workmanship.



Ex-stock availability.*



These products have been tested and approved. Details on request.



All our products are made and manufactured in the UK.



Our Standard pedestals are tested and approved to BS4877-7:1998 Test Level 3 and achieved 40,000 cycles with a static load of 20kg without failure.

OUR ACCREDITATIONS & CERTIFICATES



GB13/87763 ISO9001:2015
GB13/87762 ISO14001:2015

ISO International Standards ensure that products and services are safe, reliable and of good quality. For business, they are strategic tools that reduce costs by minimizing waste and errors and increasing productivity. To date, we are one of only 5 companies in the UK to be awarded the 2015 certification.



The mark of responsible forestry

By achieving this certification it shows our consideration for people, wildlife and the environment. You can buy our products with the confidence that you are not contributing to the destruction of the world's forests.



CONTRACTORS HEALTH & SAFETY ASSESSMENT SCHEME
Accredited Contractor
www.chas.gov.uk

CHAS is established as the market leader for health and safety pre-qualification in the UK. It is available to suppliers (those who provide goods and services) and to organisations (buyers) looking for suitably competent suppliers.

SPACE PLANNING



Our design experts are fully trained in the latest CAD software to provide detailed visuals and space layout advice for projects of all sizes – if you have any specific needs just let our design team help.

Due to our continued investment in state-of-the-art Homag machinery solutions in the factory, alongside WoodCAM software, we can offer bespoke and special order products to your exact project requirements. We really can provide furniture solutions for your exact needs, from concept to creation.

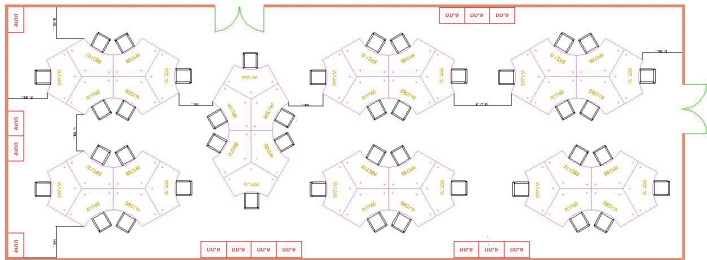

*Terms apply, speak to your account manager for details **May exclude certain products.

5 RANGES. 23 COLOURS.

We have an ever expanding range of finishes across our office furniture collections, which now includes:

- 5 desktop colour options
- 23 storage colour options

STORAGE COLOUR OPTIONS

REFLECTIONS

Distinctive and Sophisticated
6 high gloss MFC finishes available in:
Light Olive, Dark Olive, Black, White Gloss, Burgundy, Stone



KALEIDOSCOPE

Bright and Bold
6 Formica MFC finishes available in:
Green, Orange, White, Red, Yellow, Light Blue



HD

Handless Options - Touch To Open
3 high gloss laminated finishes available in:
Blue Metallic, Frost White, Grey Anthracite



SYLVAN

Classic Woodgrains
4 traditional MFC finishes available in:
Beech, Walnut, Maple, Natural Oak



URBAN

Textured Finishes
4 urban and contemporary colours
Concrete, Platinum Oak, Pitted Steel, Rusted Steel

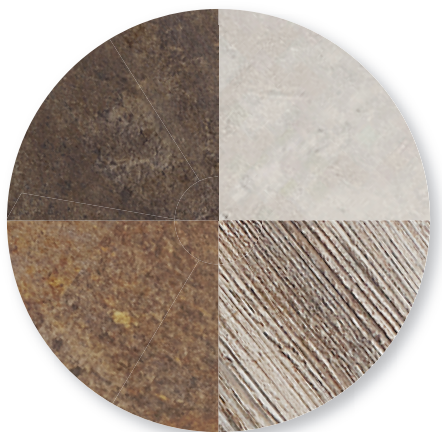

DESKTOP OPTIONS

All of our desks are available in a choice of classic Woodgrains and Matt White.

5 MFC desktop finishes available in:
Beech, Walnut, Matt White, Maple, Natural Oak



FREE DELIVERY SERVICE

ON ALL ORDERS OVER £250 IN ZONES 1&2

Having a large manufacturing and warehouse facility means we can offer industry leading delivery times - with a guaranteed 7 working day policy available on most of the Bluespot Collection.

We cover all of the UK. Using postcode zones allows us to be as clear as possible with our pricing and minimum order.



Zones 1 & 2

Free delivery minimum order value = £250 (net) - £40 (net) charge if below minimum value

Zones 3 & 5

Free delivery minimum order value = £500 (net) - £50 (net) charge if below minimum value

Zones 4 & 6

Free delivery minimum order value = £1000 (net) - £75 (net) charge if below minimum value

Northern & Republic of Ireland

Terms /POA.

DELIVERY & INSTALL

PREMIUM DELIVERY FOR JUST 15%



We offer a simple costing structure for premium delivery - for just 15% of net order value - for all our standard office furniture.



Zones 1 & 2

Cost = Additional 15% of net product price - note: £500 (net) minimum order value

Zones 3 & 5

Cost = Additional 15% of net product price - note: £1000 (net) minimum order value

Zones 4 & 6

Cost = Additional 15% of net product price - note: £1500 (net) minimum order value

Northern & Republic of Ireland

Terms/POA.

*Terms apply, speak to your account manager for details



Delivery & Install Available + 15% of Product Price



REACT

HEIGHT ADJUSTABLE DESKS

650mm
to
1300mm

Height range

120kg

Capacity

40mm/s

Speed

39db

Sound



With anti collision

70mm

Frame thickness



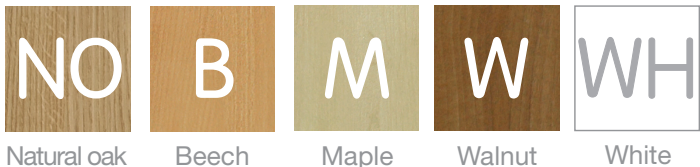

Delivery & Install Available + 15% of net product price



Height range



Capacity



Speed



Sound



With anti collision



Frame thickness



React - Height Adjustable Desks

React - Height Adjustable Desks







*Silver or white leg frame option - please specify when ordering (Code - SIL = Silver Frame, Code - WHI = White Frame)

Code	WxDxH (mm)	RRP (£)
REACT12	1200x800x650-1300	1225
REACT14	1400x800x650-1300	1275
REACT16	1600x800x650-1300	1349
REACT18	1800x800x650-1300	1399
REACT20	2000x800x650-1300	1450

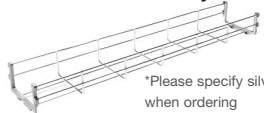

REACT ACCESSORIES

ACCESSORISE YOUR DESK

	Code	RRP (£)
Desk Monitor Arm  *Silver or white option - please specify when ordering (Code - SIL = Silver, Code - WHI = White) (e.g MONARM1WHI)	MONARM1	175
CPU Holder  *Silver or white option - please specify when ordering (Code - SIL = Silver, Code - WHI = White) (e.g UCPUS2WHI)	UCPUS2	125
Powerport  *Please specify silver when ordering (Code - SIL = Silver) (e.g PORT-EL-80SIL)	PORT-EL-80	165
Desk Cable Tray  *Please specify silver when ordering (Code - SIL = Silver) (e.g WCT1200SIL)	WCT1200 WCT1400 WCT1600 WCT1800	79 93 101 118
Cable Slinky  *Silver or white option - please specify when ordering (Code - SIL = Silver, BL = Black Code - WHI = White) (e.g SLINKYWHI)	SLINKY	125

ALUMINUM FABRIC SCREEN WITH TOOL RAIL





Fabric with tool rail

Available from

£199

RRP

More info on page 71

	Code	RRP (£)
Tool Rail Monitor Arm  *Silver or white option - please specify when ordering (Code - SIL = Silver, Code - WHI = White) (e.g MONARM3WHI)	MONARM3	175
Paper Tray  *Silver or white option - please specify when ordering (Code - SIL = Silver, Code - WHI = White) (e.g PMTRAYWHI)	PMTRAY	65
Pen Pot  *Silver or white option - please specify when ordering (Code - SIL = Silver, Code - WHI = White) (e.g PEN-POTWHI)	PEN-POT	49

i10 BENCH





Delivery & Install Available + 15% of net product price



Rectangular Desking

Rectangular Desk

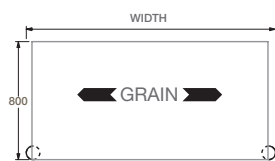

Code

WxDxH (mm)

RRP (£)

i10BD8080	860x800x730	748
i10BD1080	1060x800x730	781
i10BD1280	1260x800x730	843
i10BD1480	1460x800x730	848
i10BD1680	1660x800x730	854
i10BD1880	1860x800x730	1029
i10BD2080	2060x800x730	1034
i10BD2280	2260x800x730	1039

Rectangular Desk Add-On Desk

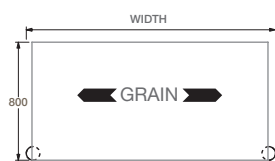

i10BDAOU8080	860x800x730	454
i10BDAOU1080	1060x800x730	487
i10BDAOU1280	1260x800x730	549
i10BDAOU1480	1460x800x730	555
i10BDAOU1680	1660x800x730	560
i10BDAOU1880	1860x800x730	735
i10BDAOU2080	2060x800x730	740
i10BDAOU2280	2260x800x730	746

Double Sided Rectangular Desk

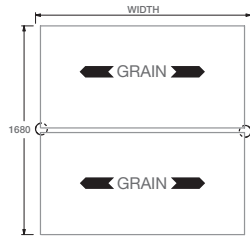

Double Sided Rectangular Add-On Desk

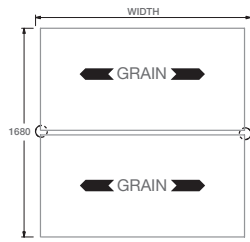

Mobile Meeting Table

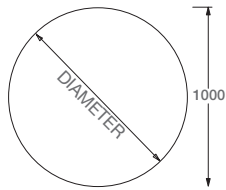

Code	WxDxH (mm)	RRP (£)
i10BDBB8016	860x1680x730	1220
i10BDBB1016	1060x1680x730	1259
i10BDBB1216	1260x1680x730	1326
i10BDBB1416	1460x1680x730	1336
i10BDBB1616	1660x1680x730	1347
i10BDBB1816	1860x1680x730	1357
i10BDBB2016	2060x1680x730	1367
i10BDBB2216	2260x1680x730	1378
<hr/>		
i10BDBBAOU8016	860x1680x730	752
i10BDBBAOU1016	1060x1680x730	791
i10BDBBAOU1216	1260x1680x730	858
i10BDBBAOU1416	1460x1680x730	868
i10BDBBAOU1616	1660x1680x730	879
i10BDBBAOU1816	1860x1680x730	889
i10BDBBAOU2016	2060x1680x730	899
i10BDBBAOU2216	2260x1680x730	910
<hr/>		
i10CT10	1000mm Dia Circular	388

Low Mobile Pedestals Page 60



Aluminium Desk Mounted Screens Page 71



R8 BENCH



R8 BENCH

DESKS



Built in cable tray

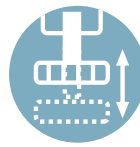

Adjustable feet



Leg sharing system

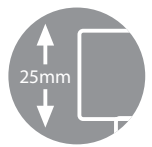

Robust design



Delivery & Install Available + 15% of net product price



Rectangular Desking

800mm/600mm Rectangular Desking

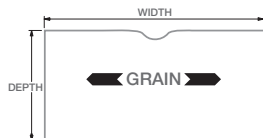

*Silver or white leg frame option - please specify when ordering
(Code - SIL = Silver Frame, Code - WHI = White Frame)

800mm/600mm Rectangular Add-On-Units

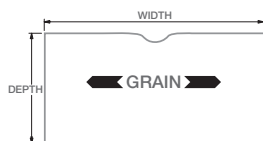

*Silver or white leg frame option - please specify when ordering
(Code - SIL = Silver Frame, Code - WHI = White Frame)

Code	WxDxH (mm)	RRP (£)
R8B1880	1800x800x740	590
R8B1680	1600x800x740	558
R8B1480	1400x800x740	535
R8B1280	1200x800x740	510
R8B1080	1000x800x740	494
R88080	800x800x740	475
R8B1860	1800x600x740	561
R8B1660	1600x600x740	531
R8B1460	1400x600x740	510
R8B1260	1200x600x740	488
R8B1060	1000x600x740	475
R8BAOU1880	1800x800x740	463
R8BAOU1680	1600x800x740	431
R8BAOU1480	1400x800x740	408
R8BAOU1280	1200x800x740	384
R8BAOU1080	1000x800x740	367
R8BAOU8080	800x800x740	348
R8BAOU1860	1800x600x740	426
R8BAOU1660	1600x600x740	396
R8BAOU1460	1400x600x740	376
R8BAOU1260	1200x600x740	354
R8BAOU1060	1000x600x740	340

1600mm/1200mm Rectangular Desking

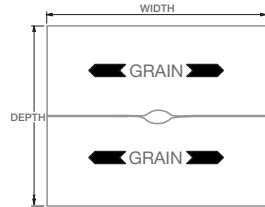

*Silver or white leg frame option - please specify when ordering
(Code - SIL = Silver Frame, Code - WHI = White Frame)

Code	WxDxH (mm)	RRP (£)
R8B1816	1800x1600x740	819
R8B1616	1600x1600x740	783
R8B1416	1400x1600x740	736
R8B1216	1200x1600x740	706
R8B1016	1000x1600x740	668
R8B8016	800x1600x740	631
R8B1812	1800x1200x740	771
R8B1612	1600x1200x740	729
R8B1412	1400x1200x740	688
R8B1212	1200x1200x740	654
R8B1012	1000x1200x740	631

1600mm/1200mm Rectangular Add-On-Units

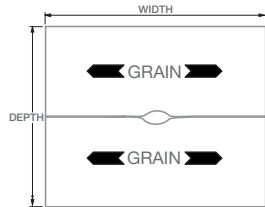

*Silver or white leg frame option - please specify when ordering
(Code - SIL = Silver Frame, Code - WHI = White Frame)

R8BAOU1816	1800x1600x740	710
R8BAOU1616	1600x1600x740	676
R8BAOU1416	1400x1600x740	631
R8BAOU1216	1200x1600x740	603
R8BAOU1016	1000x1600x740	567
R8BAOU8016	800x1600x740	531
R8BAOU1812	1800x1200x740	690
R8BAOU1612	1600x1200x740	648
R8BAOU1412	1400x1200x740	606
R8BAOU1212	1200x1200x740	572
R8BAOU1012	1000x1200x740	549

Return Desking

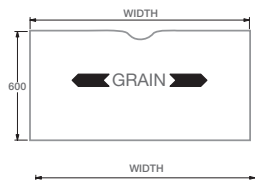

*Silver or white leg frame option - please specify when ordering
(Code - SIL = Silver Frame, Code - WHI = White Frame)

R8BFR16	1600x600x740	351
R8BFR14	1400x600x740	337
R8BFR12	1200x600x740	331
R8BFR10	1000x600x740	319

Aluminium Desk Mounted Screens Page 71





120 Degree 3 Way Cluster

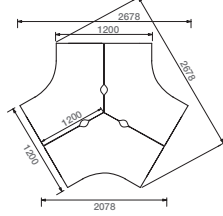

*Silver or white leg frame option - please specify when ordering
(Code - SIL = Silver Frame, Code - WHI = White Frame)

120 Degree 3 Way Cluster Add-on

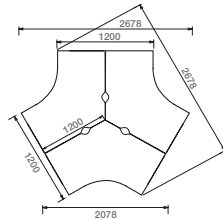

*Silver or white leg frame option - please specify when ordering
(Code - SIL = Silver Frame, Code - WHI = White Frame)

Code	WxDxH (mm)	RRP (£)
R8BW1066CLUSTER	1000x1000x600x740	1471
R8BW1266CLUSTER	1200x1200x600x740	1571
R8BW1088CLUSTER	1000x1000x800x740	1635
R8BW1288CLUSTER	1200x1200x800x740	1769
R8BWAOU1066CLUSTER	1000x1000x600x740	1394
R8BWAOU1266CLUSTER	1200x1200x600x740	1494
R8BWAOU1088CLUSTER	1000x1000x800x740	1567
R8BWAOU1288CLUSTER	1200x1200x800x740	1702



Delivery & Install Available + 15% of net product price

 Frame System - R8 Bench System

Silver Frame



White Frame



Low Mobile Pedestals Page 60



X5 BENCH





X5 BENCH



Cable port



Cable management beam system

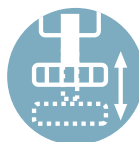

Adjustable feet



Leg sharing system

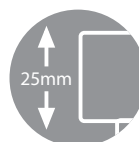

Robust design



10 Day Delivery & Install Available + 15% of net product price



Rectangular Desking

800mm/600mm Rectangular Desk

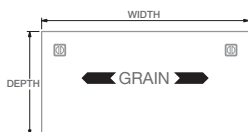

Code

WxDxH (mm)

RRP (£)

BB2280	2200x800x730	456
BB2080	2000x800x730	444
BB1880	1800x800x730	431
BB1680	1600x800x730	420
BB1480	1400x800x730	408
BB1280	1200x800x730	396
BB1080	1000x800x730	385
BB8080	800x800x730	372
BB2060	2000x600x730	420
BB1860	1800x600x730	408
BB1660	1600x600x730	396
BB1460	1400x600x730	385
BB1260	1200x600x730	372
BB1060	1000x600x730	360

800mm/600mm Rectangular Add-On Units

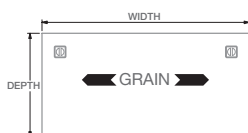

Intermediate end frames not available on single sided units

BBAOU2280	2200x800x730	355
BBAOU2080	2000x800x730	342
BBAOU1880	1800x800x730	332
BBAOU1680	1600x800x730	319
BBAOU1480	1400x800x730	306
BBAOU1280	1200x800x730	296
BBAOU1080	1000x800x730	283
BBAOU8080	800x800x730	272
BBAOU2060	2000x600x730	332
BBAOU1860	1800x600x730	319
BBAOU1660	1600x600x730	306
BBAOU1460	1400x600x730	296
BBAOU1260	1200x600x730	283
BBAOU1060	1000x600x730	272

1600mm Rectangular Desk

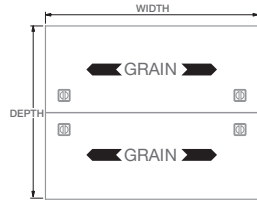

Code	WxDxH (mm)	RRP (£)
BB2216	2200x1600x730	792
BB2016	2000x1600x730	769
BB1816	1800x1600x730	745
BB1616	1600x1600x730	720
BB1416	1400x1600x730	696
BB1216	1200x1600x730	673
BB1016	1000x1600x730	650
BB8016	800x1600x730	625

1600mm Rectangular Add-On Units

(Includes 1x shared intermediate leg - X5B1600S)

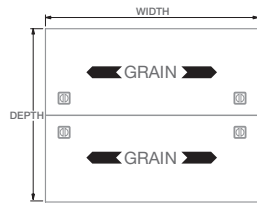

BBAOU2216	2200x1600x730	650
BBAOU2016	2000x1600x730	625
BBAOU1816	1800x1600x730	602
BBAOU1616	1600x1600x730	579
BBAOU1416	1400x1600x730	555
BBAOU1216	1200x1600x730	530
BBAOU1016	1000x1600x730	507
BBAOU8016	800x1600x730	483

Return Desking

(Includes 2x linking plates)

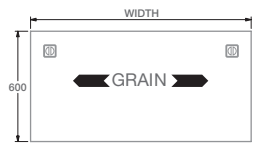

BBFR16	1600x600x730	319
BBFR14	1400x600x730	306
BBFR12	1200x600x730	301
BBFR10	1000x600x730	289



Wave Desking

1000/800mm - 800/600mm Wave Desk

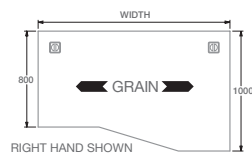

BBSW1880L/R	1800x800/1000x730	456
BBSW1680L/R	1600x800/1000x730	444
BBSW1480L/R	1400x800/1000x730	431
BBSW1280L/R	1200x800/1000x730	420
BBSW1860L/R	1800x600/800x730	444
BBSW1660L/R	1600x600/800x730	431
BBSW1460L/R	1400x600/800x730	420
BBSW1260L/R	1200x600/800x730	408

1000/800mm - 800/600mm Wave Add-On

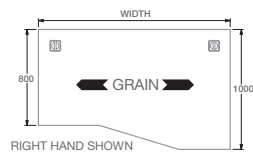

BBSWAOU1880L/R	1800x800/1000x730	355
BBSWAOU1680L/R	1600x800/1000x730	342
BBSWAOU1480L/R	1400x800/1000x730	332
BBSWAOU1280L/R	1200x800/1000x730	319
BBSWAOU1860L/R	1800x600/800x730	342
BBSWAOU1660L/R	1600x600/800x730	332
BBSWAOU1460L/R	1400x600/800x730	319
BBSWAOU1260L/R	1200x600/800x730	306

1000/800mm Double Sided Wave Desk



BBSW1816	1800x1600/2000x730	792
BBSW1616	1600x1600/2000x730	769
BBSW1416	1400x1600/2000x730	745
BBSW1216	1200x1600/2000x730	722

1000/800mm Double Sided Wave Desk Add-On

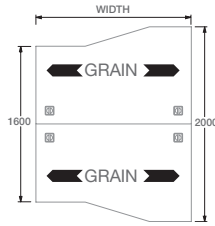

Code	WxDxH (mm)	RRP (£)
BBSWAOU1816	1800x1600/2000x730	651
BBSWAOU1616	1600x1600/2000x730	625
BBSWAOU1416	1400x1600/2000x730	602
BBSWAOU1216	1200x1600/2000x730	579



Asymmetric Desking

Asymmetric Workstation

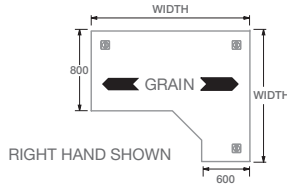

BBW1412L/R	1400x1170x730	550
BBW1612L/R	1600x1170x730	563
BBW1812L/R	1800x1170x730	575
BBW1616L/R	1600x1600x730 (800x800 Ends)	675

Asymmetric Workstation

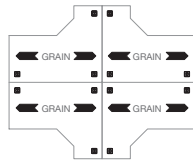

BBFWC36	3600x1600x1200x2340	2024
BBFWC32	3200x1600x1200x2340	1977
BBFWC28	2800x1600x1200x2340	1928



Frame System - X5 Bench

X5B1600S 1600mm Shared Intermediate Leg

PMP Power Mounting Plate (optional)



Telescopic Beam

SAB Short Beam (used on desks 800-1200mm)
LAB Long Beam (used on desks 1400-2200mm)

X5B1200 1200mm End Leg
X5B1600 1600mm End Leg



CANTILEVER



X5 CANTILEVER



Cable port



Cable management beam system

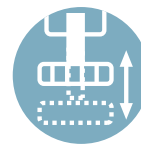

Adjustable feet



Leg sharing system



Robust design



10 Day Delivery & Install Available + 15% of net product price



Rectangular Desking

Rectangular Desking



Code

WxDxH (mm)

RRP (£)

B8	800x800x730	305
B10	1000x800x730	328
B12	1200x800x730	339
B14	1400x800x730	352
B16	1600x800x730	363
B18	1800x800x730	374
BFR10	1000x600x730	328
BFR12	1200x600x730	339

Rectangular Add-On-Desk



BAOU8	800x800x730	232
BAOU10	1000x800x730	254
BAOU12	1200x800x730	266
BAOU14	1400x800x730	279
BAOU16	1600x800x730	289
BAOU18	1800x800x730	301



Wave Desking

Single Wave Desking

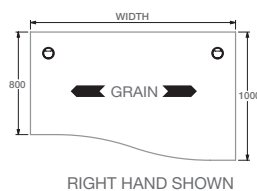

BSW12L/R	1200x1000/800x730	364
BSW14L/R	1400x1000/800x730	374
BSW16L/R	1600x1000/800x730	386
BSW18L/R	1800x1000/800x730	398
BFWR10L/R	1000x800/600x730	360
BFWR12L/R	1200x800/600x730	372

X5 CANTILEVER

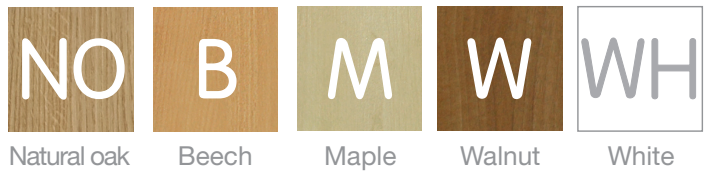

DESKS

Single Wave Desking Add-On-Desk

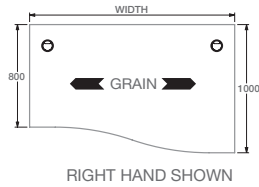

Code	WxDxH (mm)	RRP (£)
BSWAOU12L/R	1200x1000/800x730	290
BSWAOU14L/R	1400x1000/800x730	301
BSWAOU16L/R	1600x1000/800x730	313
BSWAOU18L/R	1800x1000/800x730	324

Double Wave Desking

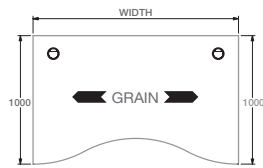

BDW16	1600x1000x730	386
BDW18	1800x1000x730	398



Radial & Managerial Desking

Computer Radial Workstation

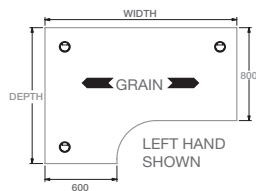

BW1412L/R	1400x1170x730	501
BW1612L/R	1600x1170x730	513
BW1812L/R	1800x1170x730	525
BW1616L/R	1600x1600x730 (800x800 Ends)	617
BRC1616L/R	1600x1600x730	629
BRC1818L/R	1800x1800x730	686

Kidney Desking

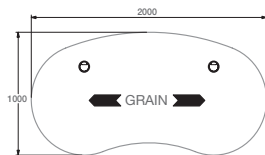

BKD2	2000x1000x730	442
------	---------------	-----

120 Degree Desking

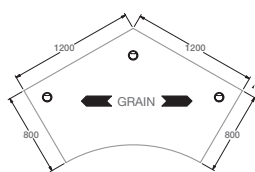

BW1288	1200x1200x730	546
--------	---------------	-----

X5 CANTILEVER

DESKS



Managerial Workstation



Code	WxDxH (mm)	RRP (£)
BW2MANL/R	2000x1170x730	714

Radial Link

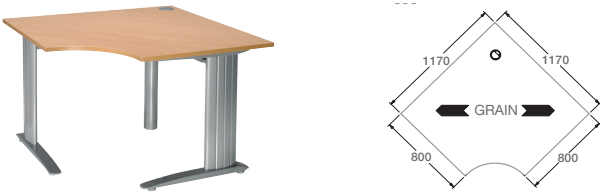

BL1288	1170x1170x730	512
--------	---------------	-----

X5 Beam System Modesty Panels (Matching MFC)

(Not for use with shared legs)



MPB8	800 MODESTY	68
MPB10	1000 MODESTY	74
MPB12	1200 MODESTY	80
MPB14	1400 MODESTY	85
MPB16	1600 MODESTY	93
MPB18	1800 MODESTY	99
MPBR12	1170 WORKSTATION MODESTY	85
MPBR14	1400 WORKSTATION MODESTY	92
MPBR16	1600 WORKSTATION MODESTY	99
MPBR18	1800 WORKSTATION MODESTY	104



10 Day Delivery & Install Available + 15% of net product price

Power Mounting Plate - Beam Fixing



Code

WxDxH (mm)

RRP (£)

PMP

Power Mounting Plate
(Beam Fixing)

10



Frame System - Cantilever

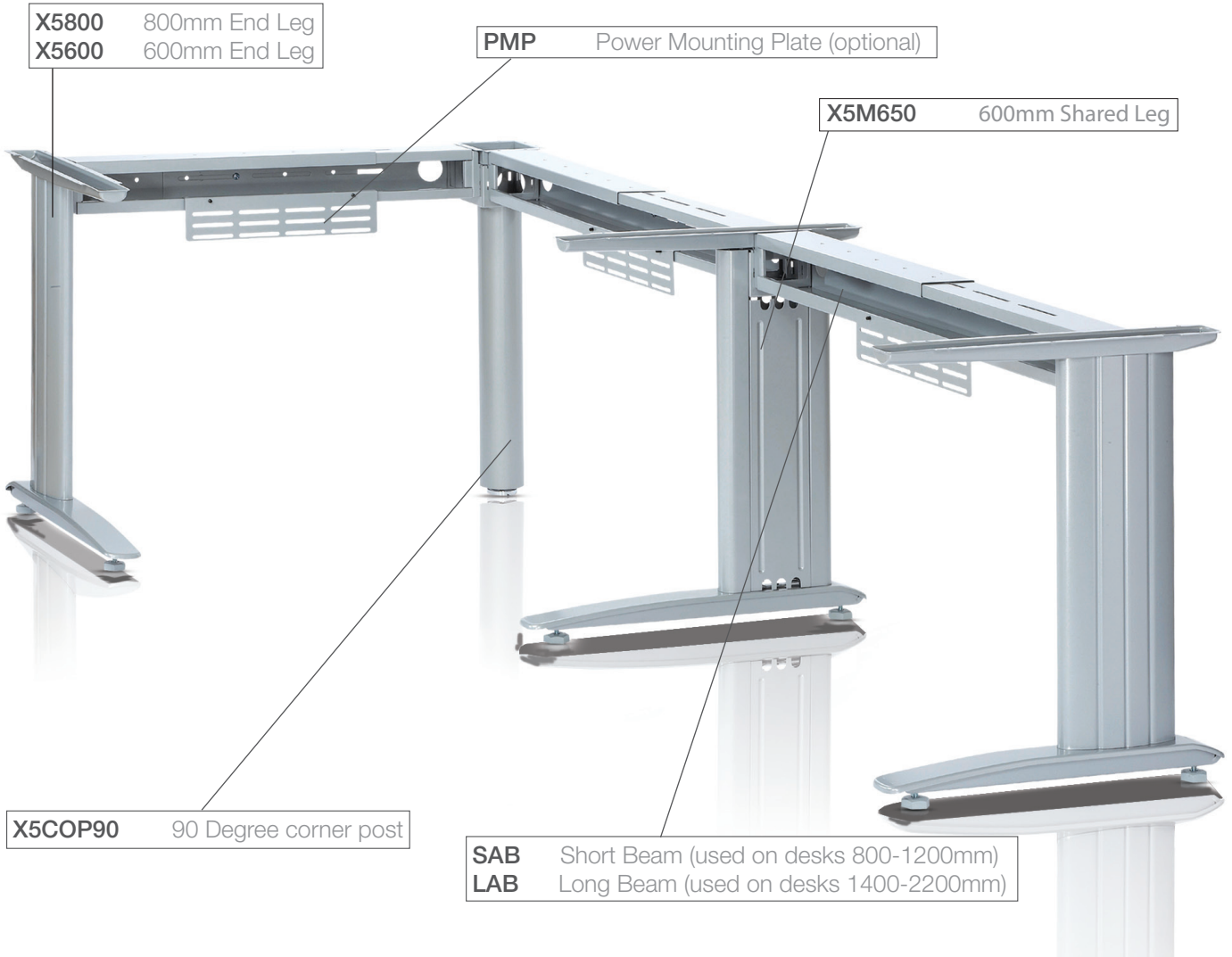

Economy Screens Page 70



N6 BENCH



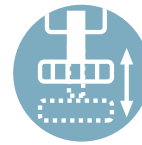

Adjustable feet



Cable Port

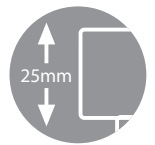

Robust design



10 Day Delivery & Install Available + 15% of net product price



Rectangular Desking

Rectangular Desking

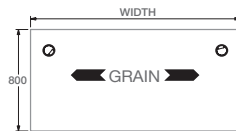

*Silver or white leg frame option - please specify when ordering
(Code - SIL = Silver Frame, Code - WHI = White Frame)

Code

WxDxH (mm)

RRP (£)

N6B10
N6B12
N6B14
N6B16
N6B18
N6BR10*

1000x800x730
1200x800x730
1400x800x730
1600x800x730
1800x800x730
1000x600x730

*(no modesty & no cable port)

299
309
319
327
339
289



Wave Desking

Single Wave Desking

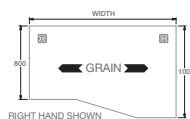

*Silver or white leg frame option - please specify when ordering
(Code - SIL = Silver Frame, Code - WHI = White Frame)

N6BW12L/R
N6BW14L/R
N6BW16L/R
N6BW18L/R

1200x1000x730
1400x1000x730
1600x1000x730
1800x1000x730

339
349
359
369



Example Code **N6B16DPSILM**
(1600 double pedestal, silver leg, maple top)

Pedestal desking**

REFLECTIONS (white carcass)

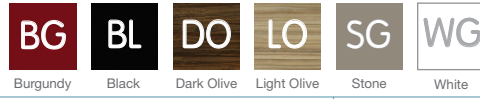

SYLVAN (woodgrain carcass)



HD (white carcass)



KALEIDOSCOPE (white carcass)

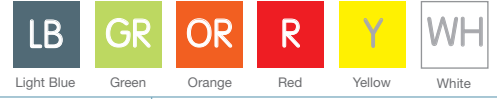

URBAN (white carcass)

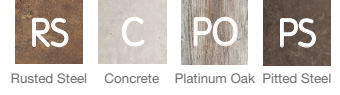

Pedestal Desking

Single Pedestal Desking

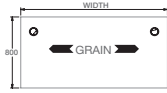

*Silver or white leg frame option - please specify when ordering
(Code - SIL = Silver Frame, Code - WHI = White Frame)
**All colour pedestals feature white desktop

Double Pedestal Desking

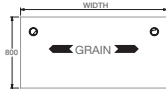

Code	WxDxH (mm)	RRP (£)
N6B12SP Sylvan Reflections Kaleidoscope Urban HD	1200x800x730	485 500 500 500 545
N6B16SP Sylvan Reflections Kaleidoscope Urban HD	1600x800x730	505 520 520 520 562
N6B16DP Sylvan Reflections Kaleidoscope Urban HD	1600x800x730	678 708 708 708 775



Economy Screens Page 70



A4 SYSTEM



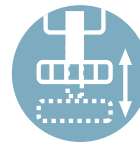

Adjustable feet



Cable port

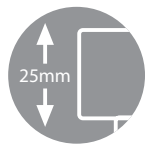

Robust design



10 Day Delivery & Install Available + 15% of net product price



Rectangular Desking

Rectangular Desking (800/600 Deep)

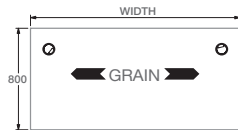

*Silver or white leg frame option - please specify when ordering
(Code - SIL = Silver Frame, Code - WHI = White Frame)

Code	WxDxH (mm)	RRP (£)
AD88	800x800x730	257
AD108	1000x800x730	262
AD128	1200x800x730	267
AD148	1400x800x730	275
AD168	1600x800x730	281
AD188	1800x800x730	286
AD86	800x600x730	245
AD106	1000x600x730	250
AD126	1200x600x730	257
AD146	1400x600x730	264
AD166	1600x600x730	269
AD186	1800x600x730	275



Wave Desking

Single Wave Desking

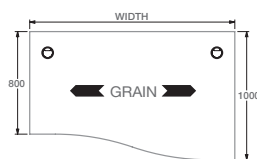

RIGHT HAND SHOWN

Code	WxDxH (mm)	RRP (£)
AWV12L/R	1200x1000/800x730	348
AWV14L/R	1400x1000/800x730	353
AWV16L/R	1600x1000/800x730	360
AWV18L/R	1800x1000/800x730	368

*Silver or white leg frame option - please specify when ordering
(Code - SIL = Silver Frame, Code - WHI = White Frame)

		Code	WxDxH (mm)	RRP (£)
Double Wave Desking 		AWVD16 AWVD18	1600x1000x730 1800x1000x730	360 368
<small>*Silver or white leg frame option - please specify when ordering (Code - SIL = Silver Frame, Code - WHI = White Frame)</small>				

 **Radial Desking**

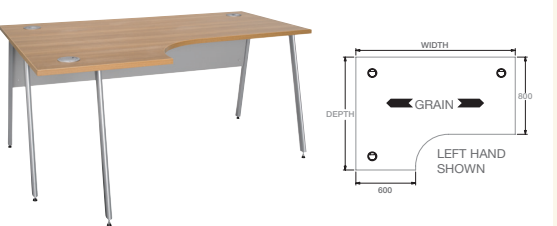
Computer Radial Workstation 		AW14L/R AW16L/R AW18L/R AW1616L/R	1400x1170x730 1600x1170x730 1800x1170x730 1600x1600x730	385 399 409 535
<small>*Silver or white leg frame option - please specify when ordering (Code - SIL = Silver Frame, Code - WHI = White Frame)</small>				

Wire Cable Tray (Silver Finish) 		WCT800 WCT1000 WCT1200 WCT1400 WCT1600 WCT1800	800mm Desk Cable Tray (length 600mm) 1000mm Desk Cable Tray (length 800mm) 1200mm Desk Cable Tray (length 1000mm) 1400mm Desk Cable Tray (length 1200mm) 1600mm Desk Cable Tray (length 1400mm) 1800mm Desk Cable Tray (length 1600mm)	47 61 79 93 101 118
--	--	---	---	------------------------------------

Low Mobile Pedestals Page 60



M3 SYSTEM





Modesty cut out

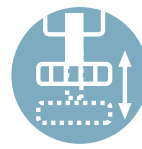

Adjustable feet



Cable port



In-leg cable management



10 Day Delivery & Install Available + 15% of net product price



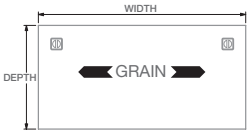

Rectangular Desking

	Code	WxDxH (mm)	RRP (£)
 	Rectangular Desking		
	MD8	800x800x730	252
	MD10	1000x800x730	258
	MD12	1200x800x730	263
	MD14	1400x800x730	271
	MD16	1600x800x730	277
	MD18	1800x800x730	283
	FSMR10	1000x600x730	258
	FSMR12	1200x600x730	263

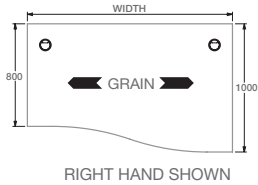

Wave Desking

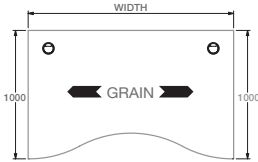
 	Single Wave Desking		
	MWV12L/R	1200x1000/800x730	346
	MWV14L/R	1400x1000/800x730	352
	MWV16L/R	1600x1000/800x730	359
	MWV18L/R	1800x1000/800x730	367
	FSMWR10L/R	1000x800/600x730	289
	FSMWR12L/R	1200x800/600x730	302
 	Double Wave Desking		
	MWVD16	1600x1000x730	359
	MWVD18	1800x1000x730	367

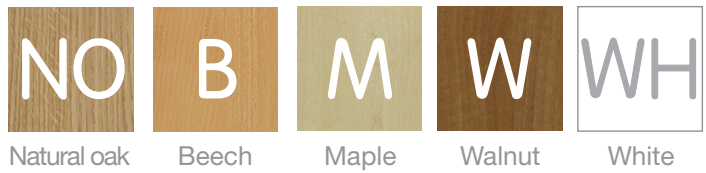

		Code	WxDxH (mm)	RRP (£)
Computer Radial Workstation		MW14L/R MW16L/R MW18L/R MW1616L/R	1400x1170x730 1600x1170x730 1800x1170x730 1600x1600x730 (800x800 Ends)	385 399 410 540
Kidney Desking		MBKD2	2000x1000x730	510
120 Degree Workstation		MW1288	1200x1200x730	444
Managerial Workstation		MMANL/R	2000x1170x730	571
Radial Link		ML1288	1170x1170x730	410

Low Mobile Pedestals Page 60



B2 SYSTEM



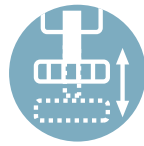

Adjustable feet



Leg sharing system



Cable port



10 Day Delivery & Install Available + 15% of net product price



Rectangular Desking

Rectangular Desking

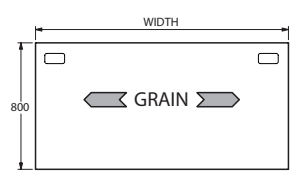

Code	WxDxH (mm)	RRP (£)
B2RD12	1200x800x730	197
B2RD16	1600x800x730	226

Back To Back Desking

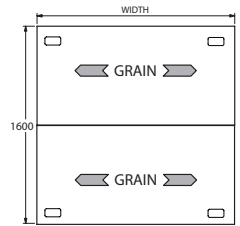

B2AORD12	1200x800x730	355
B2AORD16	1600x800x730	423



Wave Desking

Single Wave Desking

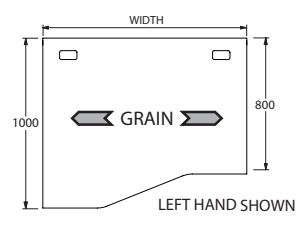

B2WV12	1200x1000/800x730	235
B2WV16	1600x1000/800x730	277

Rectangular and wave desking

NO Natural Oak **WH** White

Example Code **B2RDDP16WHLB** (1600 double pedestal, white top)

REFLECTIONS (white carcass)

BG Burgundy **BL** Black **DO** Dark Olive **LO** Light Olive **SG** Stone **WG** White

KALEIDOSCOPE (white carcass)

LB Light Blue **GR** Green **OR** Orange **R** Red **Y** Yellow **WH** White

SYLVAN (woodgrain carcass)

M Maple **B** Beech **W** Walnut **NO** Natural Oak

HD (white carcass)

GA Grey Anthracite **BM** Blue Metallic **FW** Frost White

URBAN (white carcass)

RS Rusted Steel **C** Concrete **PO** Platinum Oak **PS** Pitted Steel

DESKS



Pedestal Desking

Single Pedestal Desking

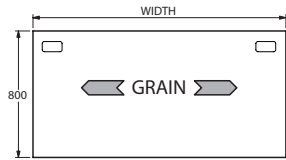

Code	WxDxH (mm)	RRP (£)
B2RDSP12	1200x800x730	
Sylvan		340
Reflections		375
Kaleidoscope		375
Urban		375
HD		386
B2RDSP16	1600x800x730	
Sylvan		369
Reflections		406
Kaleidoscope		406
Urban		406
HD		415



All colour pedestals feature white desktop

Double Pedestal Desking

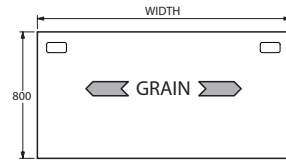

B2RDDP16	1600x800x730	
Sylvan		512
Reflections		563
Kaleidoscope		563
Urban		563
HD		572

All colour pedestals feature white desktop

Computer Radial Workstation

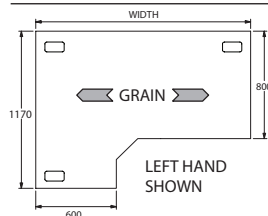

B2W16L/R	1600x1170x730	317
-----------------	---------------	-----

Back To Back Desk With Screen

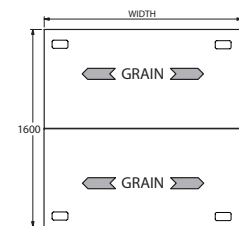

B2BRD12ALU	1200x1600x730 (Aluminium)	595
B2BRD16ALU	1600x1600x730 (Aluminium)	684
B2BRD12DMSS	1200x1600x730 (Economy)	532
B2BRD16DMSS	1600x1600x730 (Economy)	612

See page 70 for full list of screen options & colours

Two Door Storage Page 63



C3 CANTILEVER





Modesty cut out

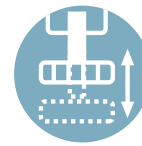

Adjustable feet



Cable port

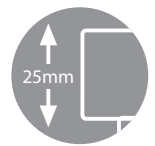

Robust design



10 Day Delivery & Install Available + 15% of net product price



Rectangular Desking

Rectangular Desking

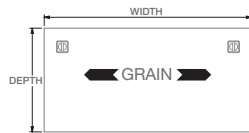

Code

WxDxH (mm)

RRP (£)

CD8	800x800x730	215
CD10	1000x800x730	220
CD12	1200x800x730	227
CD14	1400x800x730	233
CD16	1600x800x730	239
CD18	1800x800x730	244
FSCR10	1000x600x730	220
FSCR12	1200x600x730	227



Wave Desking

Single Wave Desking

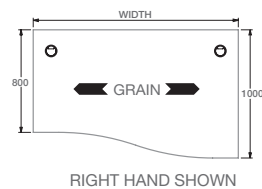

CWV12L/R	1200x1000/800x730	284
CWV14L/R	1400x1000/800x730	292
CWV16L/R	1600x1000/800x730	297
CWV18L/R	1800x1000/800x730	303
FSCWR10L/R	1000x800/600x730	257
FSCWR12L/R	1200x800/600x730	268

Double Wave Desking

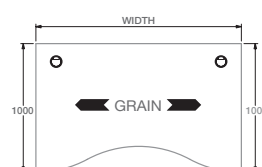

CDWV16	1600x1000x730	297
CDWV18	1800x1000x730	303

Computer Radial Workstation

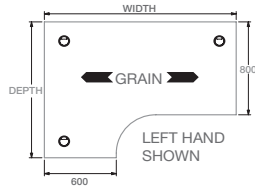

Code	WxDxH (mm)	RRP (£)
CW14L/R	1400x1170x730	310
CW16L/R	1600x1170x730	314
CW18L/R	1800x1170x730	339
CW1616L/R	1600x1600x730 (800x800 Ends)	475

Kidney Desking

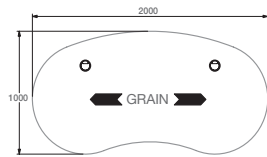

CBKD2	2000x1000x730	451
-------	---------------	-----

120 Degree Workstation

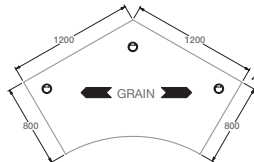

CW1288	1200x1200x730	391
--------	---------------	-----

Managerial Workstation

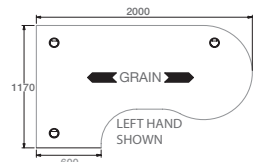

CMANI/R	2000x1000x730	507
---------	---------------	-----

Radial Link

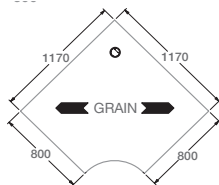

CL1288	1170x1170x730	363
--------	---------------	-----

Fixed Pedestals Page 59



C3 PANEL END



C3 PANEL END

DESKS



Modesty cut out

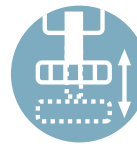

Adjustable feet



Cable port

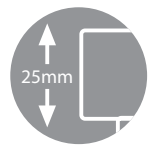

Robust design



10 Day Delivery & Install Available + 15% of net product price



Rectangular Desking

Rectangular Desking

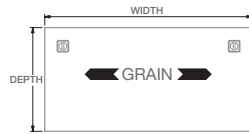

Code

WxDxH (mm)

RRP (£)

PD8	800x800x730	215
PD10	1000x800x730	220
PD12	1200x800x730	227
PD14	1400x800x730	233
PD16	1600x800x730	239
PD18	1800x800x730	244
FSPR10	1000x600x730	220
FSPR12	1200x600x730	227



Wave Desking

Single Wave Desking

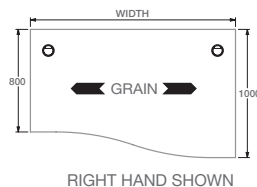

PWV12L/R	1200x1000/800x730	284
PWV14L/R	1400x1000/800x730	292
PWV16L/R	1600x1000/800x730	297
PWV18L/R	1800x1000/800x730	303
FSPWR10L/R	1000x800/600x730	257
FSPWR12L/R	1200x800/600x730	268

Double Wave Desking

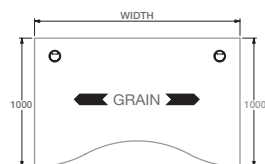

PDWV16	1600x1000x730	297
PDWV18	1800x1000x730	303



Natural oak Beech Maple Walnut White

Computer Radial Workstation

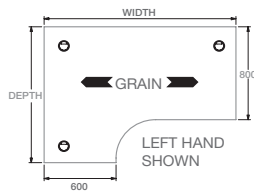

Code

PW14L/R
PW16L/R
PW18L/R
PW1616L/R

WxDxH (mm)

1400x1170x730
1600x1170x730
1800x1170x730
1600x1600x730
(800x800 Ends)

RRP (£)

310
314
339
475

Kidney Desking

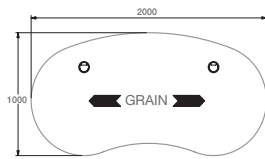

PBKD2

2000x1000x730

451

120 Degree Workstation

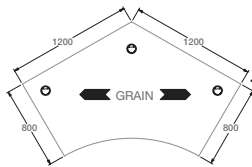

PW1288

1200x1200x730

391

Managerial Workstation

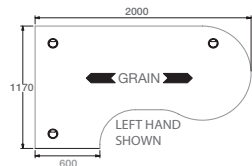

PMANL/R

2000x1170x730

507

Radial Link

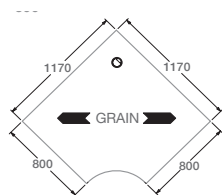

PL1288

1170x1170x730



363

Fixed Pedestals Page 59









ACCESSORIES

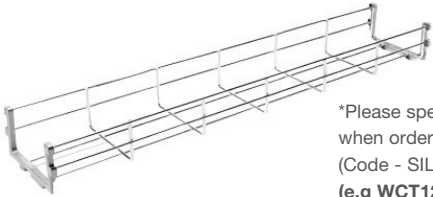

Height Adjustable Monitor Arm (desk fixing)	Code	Description	RRP (£)
 <p>*Silver or white option - please specify when ordering (Code - SIL = Silver, Code - WHI = White) (e.g MONARM1WHI)</p>	MONARM1	Silver & White Monitor Arm	175
 <p>*Silver or white option - please specify when ordering (Code - SIL = Silver, Code - WHI = White) (e.g MONARM3WHI)</p>	MONARM3	Tool Rail Fixing Monitor Arm	175

ACCESSORIES

	Code	Description	RRP (£)
<p>CPU Holder</p>  <p>*Please specify silver when ordering (Code - SIL = Silver) (e.g UCPUSIL)</p>	UCPUS	CPU holder	95
<p>Adjustable CPU Holder</p>  <p>*Silver or white option - please specify when ordering (Code - SIL = Silver, Code - WHI = White) (e.g UCPUS2WHI)</p>	UCPUS2	Base unit CPU holder fully adjustable available in silver and white	125
<p>Powerport</p>  <p>*Please specify silver when ordering (Code - SIL = Silver) (e.g PORT-EL-80SIL)</p>	PORT-EL-80	Port-el 80mm in desk power module 1 x socket, 2 x smart charge and 1 x 2mtr power lead.	165
<p>Spiral Cable Slinky</p>  <p>*Silver or white option - please specify when ordering (Code - SIL = Silver, BL = Black Code - WHI = White) (e.g SLINKYWHI)</p>	SLINKY	Spiral cable slinky 10cm to 170cm. Available in white, silver and black	125
<p>Desk Cable Tray</p>  <p>*Please specify silver when ordering (Code - SIL = Silver) (e.g WCT1200SIL)</p>	<p>WCT1200 WCT1400 WCT1600 WCT1800</p>	<p>1200mm (tray length 1000mm) 1400mm (tray length 1200mm) 1600mm (tray length 1400mm) 1800mm (tray length 1600mm)</p>	<p>79 93 101 118</p>
<p>Paper Tray</p>  <p>*Silver or white option - please specify when ordering (Code - SIL = Silver, Code - WHI = White) (e.g PMTRAYWHI)</p>	PMTRAY	A4 paper tray available in silver & white	65
<p>Pen Pot</p>  <p>*Silver or white option - please specify when ordering (Code - SIL = Silver, Code - WHI = White) (e.g PEN-POTWHI)</p>	PEN-POT	Pen pot tray available in silver & white	49

MEETING TABLES

TABLES



Natural oak

Beech

Maple

Walnut

White



10 Day Delivery & Install Available + 15% of net product price

Endless configuration possibilities for meeting tables

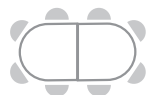
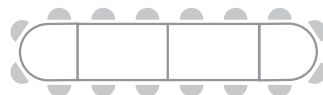
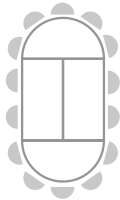
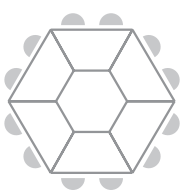

MEETING TABLES



TABLES



			TUBULAR 60mm	ARROW HD	X5 BENCH	SQUARE LEG	COLUMN BASE	TRUMPET WHITE	TRUMPET CHROME
		CODE+	TAB	MFC	X5B	SQL	CB	TWH	TCH
	CIRCULAR 900	CT9	392	N/A	424	392	392	392	450
			C/W 4 Legs		C/W 2 Legs	C/W 4 Leg	C/W 1 Legs	C/W 1 Legs	C/W 1 Legs
	CIRCULAR 1000	CT10	404	N/A	436	404	404	404	465
			C/W 4 Legs		C/W 2 Legs	C/W 4 Leg	C/W 1 Legs	C/W 1 Legs	2 Legs
	CIRCULAR 1200	CT12	416	416	447	416	416	416	480
			C/W 4 Legs	C/W 2 Legs	C/W 2 Legs	C/W 4 Leg	C/W 2 Legs	C/W 2 Legs	C/W 2 Legs
	RECTANGULAR 1600 x 1000	BCFT16	236	407	438	407	407	407	595
			C/W 4 Legs	C/W 2 Legs	C/W 2 Legs	C/W 4 Legs	C/W 2 Legs	C/W 2 Legs	C/W 2 Legs
	RECTANGULAR 2000 x 1000	BCFT20	411	411	443	411	411	411	599
			C/W 4 Legs	C/W 2 Legs	C/W 2 Legs	C/W 4 Legs	C/W 2 Legs	C/W 2 Legs	C/W 2 Legs
	OVAL 2400 x 1200	OVL24	819	819	819	819	819	819	819
			C/W 4 Legs	C/W 2 Legs	C/W 4 Legs	C/W 4 Legs	C/W 2 Legs	C/W 2 Legs	C/W 2 Legs
	BARREL 3200 x 1000 (2 piece)	BRLT32	819	819	819	819	819	819	819
			C/W 8 Legs	C/W 4 Legs	C/W 3 Legs	C/W 8 Legs	C/W 3 Legs	C/W 3 Legs	C/W 3 Legs
	'D'-END 2400 x 1000	DEFT24	819	819	819	819	819	819	819
			C/W 6 Legs	C/W 2 Legs	C/W 2 Legs	C/W 6 Legs	C/W 2 Legs	C/W 2 Legs	C/W 2 Legs
	'D'-END 3200 x 1000 (2 piece)	DEFT32	819	819	819	819	819	819	819
			C/W 8 Legs	C/W 4 Legs	C/W 3 Legs	C/W 8 Legs	C/W 3 Legs	C/W 3 Legs	C/W 3 Legs
	RECTANGULAR 1200 x 800	TAB12	196	N/A	N/A	196	N/A	N/A	N/A
			C/W 4 Legs			C/W 3 Legs			
	RECTANGULAR 1400 x 800	TAB14	229	N/A	N/A	229	229	N/A	N/A
			C/W 4 Legs				C/W 2 Legs		
	RECTANGULAR 1600 x 800	TAB16	236	N/A	N/A	236	N/A	N/A	N/A
			C/W 4 Legs			C/W 4 Legs			
	RECTANGULAR 1800 x 800	TAB18	244	N/A	N/A	244	N/A	N/A	N/A
			C/W 4 Legs			C/W 4 Legs			
	SEMI-CIRCULAR 1600 x 800	SC16	353	N/A	N/A	353	N/A	N/A	N/A
			C/W 4 Legs			C/W 4 Legs			
	TRAPEZOIDAL 1600 x 692	TTAB16	353	N/A	N/A	353	N/A	N/A	N/A
			C/W 4 Legs			C/W 4 Legs			
	MODULAR EXTENSION TABLE 1000 x 1000 <small>Note: not a stand alone item - must be linked with MET10D or MET10</small>	MET10D	N/A	290	N/A	N/A	296	296	465
				C/W 1 Leg			C/W 1 Leg	C/W 1 Leg	C/W 1 Leg
	MODULAR EXTENSION TABLE 1000 x 1000 <small>Note: not a stand alone item - must be linked with MET10D or MET10</small>	MET10	N/A	290	N/A	N/A	296	296	465
				C/W 1 Leg			C/W 2 Leg	C/W 1 Leg	C/W 1 Leg

MEETING TABLES

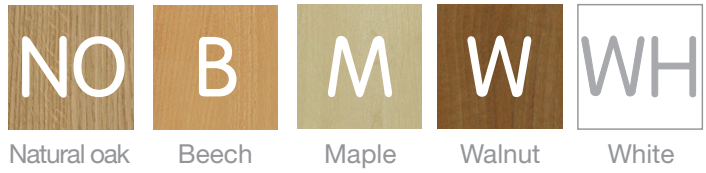

10 Day Delivery & Install Available + 15% of net product price

Flip Top Table (Silver/Black Frame)

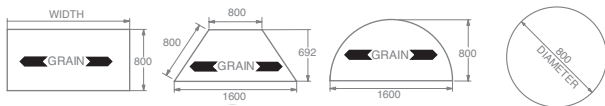

Code	WxDxH (mm)	RRP (£)
FLIP16	1600x800x730 (Rectangular)	511
FLIPTT16	1600x692x730 (Trapezoidal)	545
FLIPS16	1600x800x730 (Semi-circular)	545
FLIPCT8	800 Diameter x730 (Circular)	556
FLIPCON	Table Top Connector	51



Heavy duty flip top mechanism



Table top connector

MEETING TABLES



TABLES

Coffee Table



Code	WxDxH (mm)	RRP (£)
CTC6	600mm DIAMETERx450	329
CTC	600x600x450	238
CTC10	1000x600x450	256
CTC12	1200x600x450	269

Mobile Folding Table (Chrome Legs)

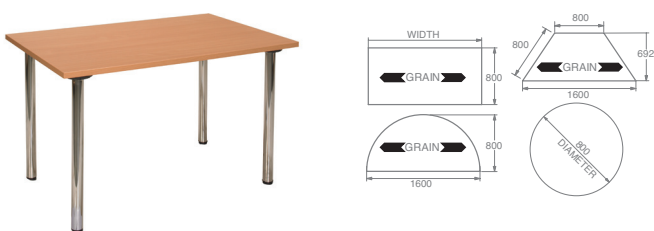

MFT12	1200x800x730 (Rectangular)	404
MFT14	1400x800x730 (Rectangular)	417
MFT16	1600x800x730 (Rectangular)	425
MFT18	1800x800x730 (Rectangular)	430
MFTS16	1600x800x730 (Semi-circular)	440
MFTT16	1600x692x730 (Trapezoidal)	440
MFTCT12	1200 Diameterx730 (Circular)	556



FLIPCON	Table Top Connector (set of 4)	51
---------	--------------------------------	----

Folding Meeting Table (Chrome Legs)



FT12	1200x800x730 (Rectangular)	404
FT14	1400x800x730 (Rectangular)	417
FT16	1600x800x730 (Rectangular)	425
FT18	1800x800x730 (Rectangular)	430
FTS16	1600x800x730 (Semi-circular)	440
FTT16	1600x692x730 (Trapezoidal)	440



FLIPCON	Table Top Connector (set of 4)	51
---------	--------------------------------	----

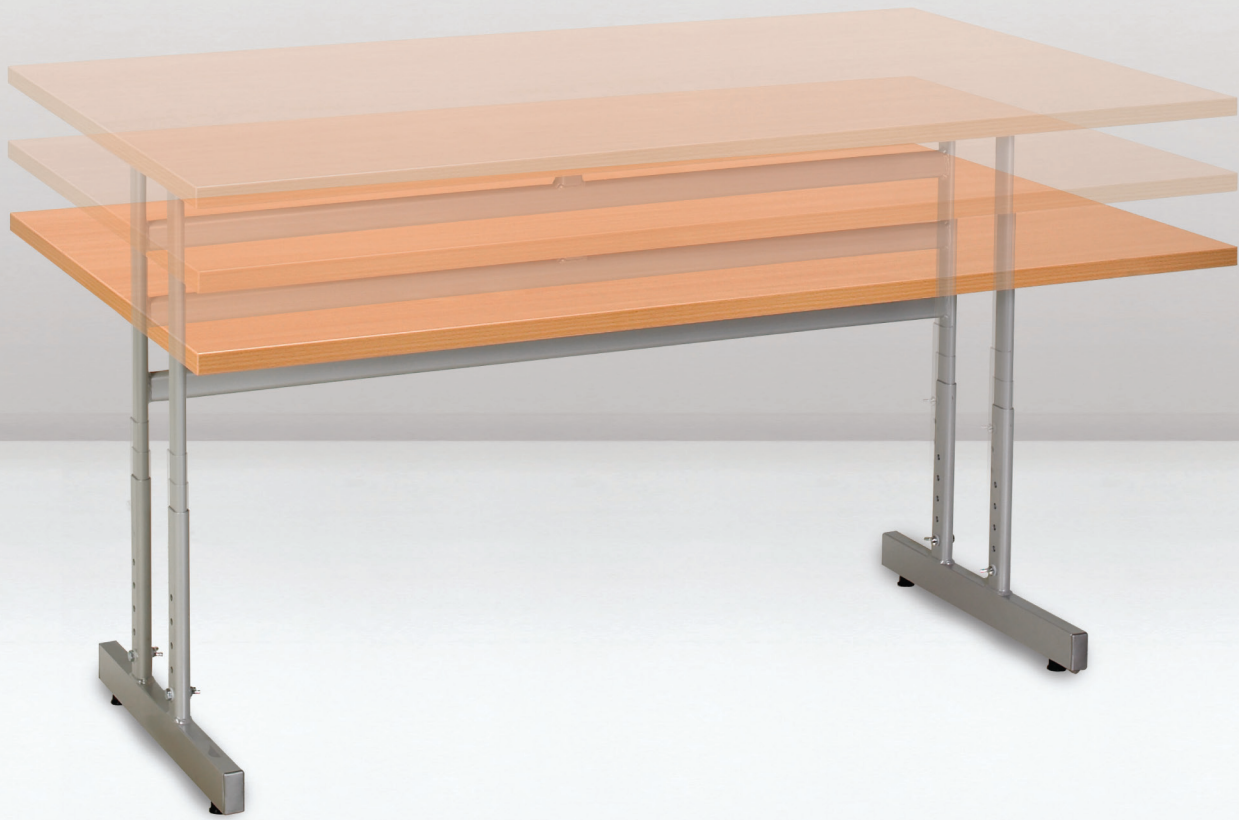

HEIGHT SETTABLE TABLE

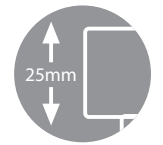
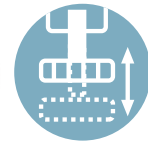
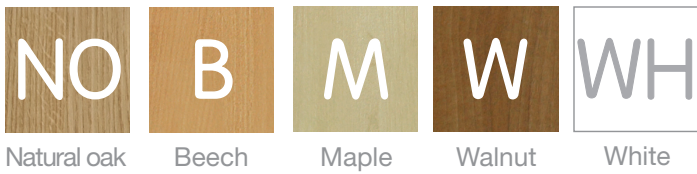

Height Settable Table



Code	WxDxH (mm)	RRP (£)
HST615735	Secondary School Use 1200x800x615/735	340
	30mm incremental adjustment 1600x800x615/735	362
HST735855	Commercial Office Use 1200x800x735/855	340
	30mm incremental adjustment 1600x800x735/855	362

Upgrade to React - Electric height adjustable system on Page 08



WELDED FRAME TABLES

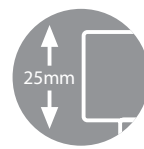
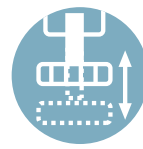

Adjustable feet

Robust design



Standard Fully Welded



Deluxe Tubular Fully Welded



Project Fully Welded

TABLES

25MM MFC TOP



	Code	WxDxH (mm)	1 to 2 RRP (£)	3 to 5 RRP (£)	6 to 10 RRP (£)	11 to 25 RRP (£)	26+ RRP (£)
Standard with 25mm MFC Top	FWF606025	600x600x730	185	160	135	120	116
	FWF1206025	1200x600x730	208	180	148	143	139
	FWF1208025	1200x800x730	210	182	150	145	141
	FWF1608025	1600x800x730	226	211	196	161	157
Deluxe Tubular with 25mm MFC Top	TUBFWF606025	600x600x730	290	252	222	217	213
	TUBFWF1206025	1200x600x730	325	283	256	250	247
	TUBFWF1208025	1200x800x730	333	292	288	259	255
	TUBFWF1608025	1600x800x730	361	331	301	274	271
Heavy Duty Set of 4 Castors	CASTOR		20	20	20	20	20
Project with 25mm MFC Top	PROJFWF606025	600x600x730	293	268	233	228	224
	PROJFWF1206025	1200x600x730	335	311	279	274	270
	PROJFWF1208025	1200x800x730	344	320	288	282	278
	PROJFWF1608025	1600x800x730	372	342	315	301	298
Heavy Duty Set of 4 Castors	CASTOR		20	20	20	20	20

12.7MM SOLID GRADE LAMINATE TOP

TRESPA® Arpa

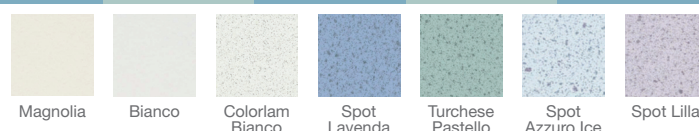

	Code	WxDxH (mm)	1 to 2 RRP (£)	3 to 5 RRP (£)	6 to 10 RRP (£)	11 to 25 RRP (£)	26+ RRP (£)
Standard with 12.7mm Solid Grade Laminate Top	FWF606013	600x600x730	N/A	294	259	254	220
	FWF1206013	1200x600x730	N/A	483	451	445	388
	FWF1208013	1200x800x730	N/A	583	553	548	479
	FWF1608013	1600x800x730	N/A	802	772	766	671
Deluxe Tubular with 12.7mm Solid Grade Laminate Top	TUBFWF606013	600x600x730	N/A	376	346	341	296
	TUBFWF1206013	1200x600x730	N/A	564	538	532	465
	TUBFWF1208013	1200x800x730	N/A	667	640	635	555
	TUBFWF1608013	1600x800x730	N/A	899	870	844	739
Heavy Duty Set of 4 Castors	CASTOR		20	20	20	20	20
Project with 12.7mm Solid Grade Laminate Top	PROJFWF606013	600x600x730	N/A	392	357	352	306
	PROJFWF1206013	1200x600x730	N/A	593	561	555	485
	PROJFWF1208013	1200x800x730	N/A	695	663	658	575
	PROJFWF1608013	1600x800x730	N/A	911	884	870	763
Heavy Duty Set of 4 Castors	CASTOR		20	20	20	20	20



Heavy duty castors with integrated corner protection which can withstand a static load of 100kg.



TRAY UNITS

Our tray units are supplied fully assembled and are multi drilled to accept several tray depths to suit client needs, with unlimited configurations.



Can be made static with unique integrated brake system

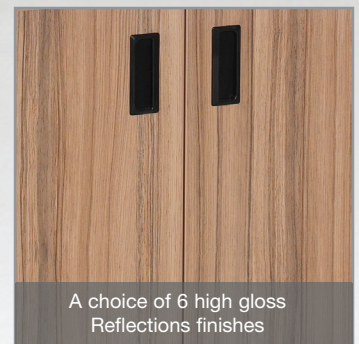

A choice of 6 high gloss Reflections finishes



Stylish flush door handles



Includes castors/corner protectors



Optional hinged doors



270 degree hinges

TRAY UNITS

Colour Options for Tray Unit Doors

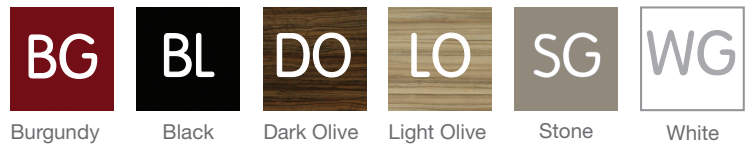

UNIVERSAL STORAGE

	Code	WxDxH (mm)	RRP (£)
Single Bay Unit 	GTSBUWH	363x475x608	132
	GTSBUDD	Carcase only (white)* 363x475x608 (c/w 1 door)	187
Double Bay Unit 	GTDBUWH	704x475x608	174
	GTDBUDD	Carcase only (white)* 704x475x608 (c/w 2 doors)	269
Triple Bay Unit 	GTTBUWH	1045x475x608	179
	GTTBUDD	Carcase only (white)* 1045x475x608 (c/w 2 doors)	285

TRAYS

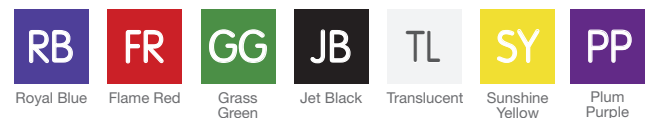

Shallow Tray c/w runners⁺ 	GST	312x427x75 (Includes universal drawer runners)	11
Deep Tray c/w runners⁺ 	GDT	312x427x150 (Includes universal drawer runners)	15
Extra Deep Tray c/w runners⁺ 	GET	312x427x608 (Includes universal drawer runners)	17

*Gratnell trays purchased separately.
*Trays cannot be purchased separate from units.
Supplied for client insertion/positioning.

UNIVERSAL STORAGE



UNIVERSAL PEDESTALS



Anti Tilt

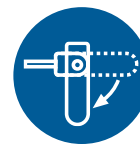

Hinged Key

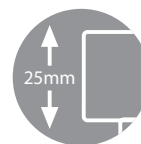

Robust design

UNIVERSAL STORAGE



10 Day Delivery & Install Available + 15% of net product price



Fixed Pedestals

Two Drawer Fixed Pedestal

Not suitable for i10, R8, X5, B2, N6 and A4 Desking

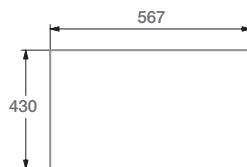

Code

WxDxH (mm)

RRP (£)

P2

Sylvan
Reflections
Kaleidoscope
Urban
HD

430x567x539.5
430x567x539.5
430x567x539.5
430x567x539.5
430x567x539.5

165
181
181
181
205

Three Drawer Fixed Pedestal

Not suitable for i10, R8, X5, B2, N6 and A4 Desking

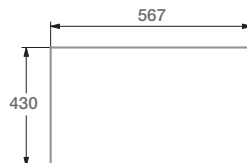

P3

Sylvan
Reflections
Kaleidoscope
Urban
HD

430x567x539.5
430x567x539.5
430x567x539.5
430x567x539.5
430x567x539.5

165
181
181
181
205



All our pedestals are manufactured and assembled on site, producing a very strong, secure and reliable pedestal. All standard pedestal drawers are produced with a powder coated mild steel drawer wrap, which smoothly glides on nylon runners for a very soft action. With a variety of different sizes and colours, we are sure to have the pedestal to suit your needs. Our standard pedestals are tested and approved to BS4877-7:1998 Test Level 3 and achieved 40,000 cycles with a static load of 20kg without failure.

REFLECTIONS (white carcass)

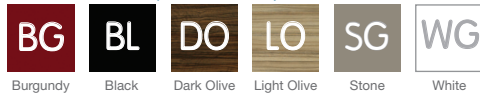

KALEIDOSCOPE (white carcass)

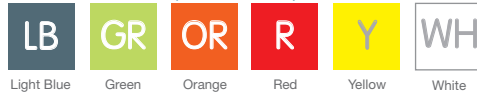

HD (white carcass)



URBAN (white carcass)



Mobile Pedestals

Two Drawer Low Mobile Pedestal

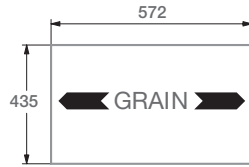

Code	WxDxH (mm)	RRP (£)
LM2		
Sylvan	435x572x567	228
Reflections	435x572x567	243
Kaleidoscope	435x572x567	243
Urban	435x572x567	243
HD	435x572x567	266

Three Drawer Low Mobile Pedestal

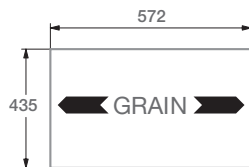

LM3		
Sylvan	435x572x567	228
Reflections	435x572x567	243
Kaleidoscope	435x572x567	243
Urban	435x572x567	243
HD	435x572x567	266

Three Drawer Narrow Tall Mobile Pedestal

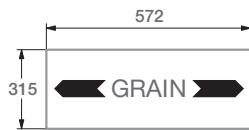

P4		
Sylvan	315x572x595	238
Reflections	315x572x595	272
Kaleidoscope	315x572x595	272
Urban	315x572x595	272
HD	315x572x595	299

Three Drawer Tall Mobile Pedestal

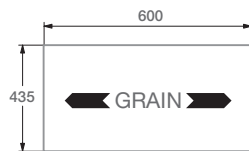

P5		
Sylvan	435x572x595	255
Reflections	435x572x595	272
Kaleidoscope	435x572x595	272
Urban	435x572x595	272
HD	435x572x595	299



Desk High Pedestals

Three Drawer Desk High Pedestal

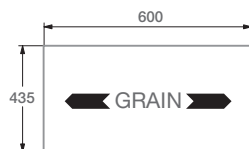

P6	435x600x730	
Sylvan		255
Reflections		272
Kaleidoscope		272
Urban		272
HD		299
P8	435x800x730	
Sylvan		276
Reflections		296
Kaleidoscope		296
Urban		296
HD		319



Metal Pedestals

Three Drawer Mobile Pedestal (c/w Pen Tray)



Description	Code	WxDxH (mm)	RRP (£)
Metal Pedestal	P5	390x565x560	269
	PT	Standard	14

Pen Tray (Optional on MFC Pedestals)



FILING AND DRAWER SPECIFICATIONS

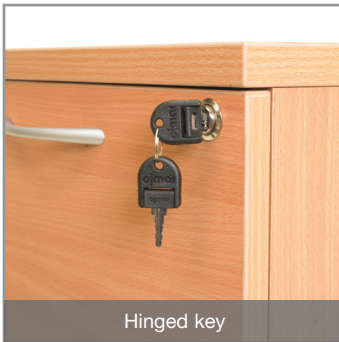

Our filing cabinets and metal pedestals have smooth action ball bearing runners tested to withstand 40kg per drawer.

REFLECTIONS (white carcass)

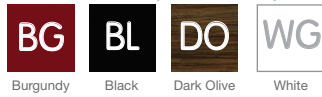

KALEIDOSCOPE (white carcass)

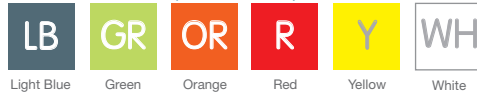

Tambour Units

Sylvan

Silver Tambour Doors

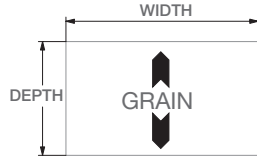

Reflections

Gloss Tambour Door



Kaleidoscope



HD



	Code	WxDxH (mm)	RRP (£)
Sylvan	T738	800x600x730 (1 MFC Shelf)	551
	T73	1056x600x730 (1 MFC Shelf)	562
	T12	1056x600x1200 (2 MFC Shelves)	652
	T16	1056x600x1600 (3 MFC Shelves)	686
	T19	1056x600x1900 (4 MFC Shelves) (Woodgrain Carcass on all)	781
Reflections	RECOPLUSFPT73	800x450x730 (1 MFC Shelf) (White Carcass)	562
	RECOPLUSFPT19	800x450x1900 (4 MFC Shelves) (White Carcass)	781
	ECOTPOF	Pull out filing frame (Steel Silver Finish)	117
Kaleidoscope	KECOPLUSFPT73	800x450x730 (1 MFC Shelf) (White Carcass)	562
	KECOPLUSFPT19	800x450x1900 (4 MFC Shelves) (White Carcass)	781
HD	HDECOPPLUST73	800x450x730 (1 MFC Shelf) (White Carcass)	562
	HDECOPPLUST19	800x450x1900 (4 MFC Shelves) (White Carcass)	781
	ECOTPOF	Pull out filing frame (Steel Silver Finish)	117

REFLECTIONS (white carcass)

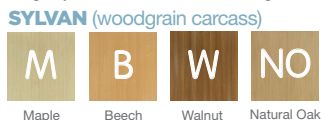
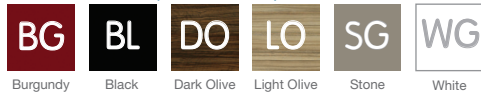

KALEIDOSCOPE (white carcass)



URBAN (white carcass)



Two Door Storage Units

Sylvan

18mm MFC Solid Back Panel & 25mm MFC Shelves

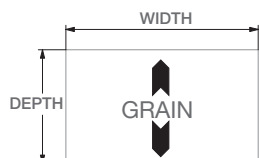

Reflections



Kaleidoscope



HD



Code	WxDxH (mm)	RRP (£)
DD738	800x600x730 (1 MFC SHELF)	339
DD73	954x600x730 (1 MFC SHELF)	357
DD12	954x600x1200 (2 MFC SHELVES)	391
DD16	954x600x1600 (3 MFC SHELVES)	437
DD19	954x600x1900 (4 MFC SHELVES) (Woodgrain Carcass on all)	566
RDD738	800x600x730 (1 MFC SHELF)	355
RDD73	954x600x730 (1 MFC SHELF)	376
RDD12	954x600x1200 (2 MFC SHELVES)	422
RDD16	954x600x1600 (3 MFC SHELVES)	477
RDD19	954x600x1900 (4 MFC SHELVES) (White Carcass on all)	614
DD738	800x600x730 (1 MFC SHELF)	355
DD73	954x600x730 (1 MFC SHELF)	376
DD12	954x600x1200 (2 MFC SHELVES)	422
DD16	954x600x1600 (3 MFC SHELVES)	477
DD19	954x600x1900 (4 MFC SHELVES) (White Carcass on all)	614
DD738	800x600x730 (1 MFC SHELF)	390
DD73	954x600x730 (1 MFC SHELF)	415
DD12	954x600x1200 (2 MFC SHELVES)	465
DD16	954x600x1600 (3 MFC SHELVES)	525
DD19	954x600x1900 (4 MFC SHELVES) (White Carcass on all)	675

REFLECTIONS (white carcass)

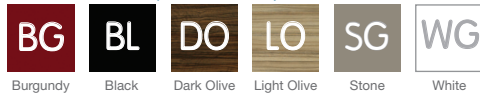

KALEIDOSCOPE (white carcass)

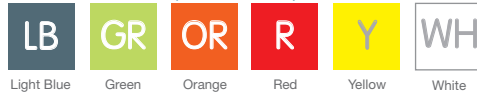

HD (white carcass)



URBAN (white carcass)

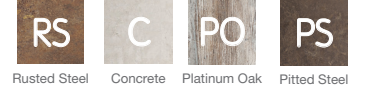

Urban



Code	WxDxH (mm)	RRP (£)
UDD738	800x600x730 (1 MFC SHELF)	355
UDD73	954x600x730 (1 MFC SHELF)	376
UDD12	954x600x1200 (2 MFC SHELVES)	422
UDD16	954x600x1600 (3 MFC SHELVES)	477
UDD19	954x600x1900 (4 MFC SHELVES) (White Carcass on all)	614



Combination Cupboard

Sylvan

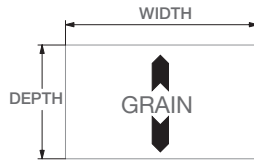

Double cabinet with 2 middle drawers

Code	WxDxH (mm)	RRP (£)
COMBI	800x600x1900 (Woodgrain Only)	336
COMBIDOOR	396x18x715 (Pair)	193
COMBIDRAWER	800x18x220 (Pair)	122

Reflections



Code	WxDxH (mm)	RRP (£)
RCOMBI	800x600x1900 (White Only)	336
RCOMBIDOOR	396x18x715 (Pair)	209
RCOMBIDRAWER	800x18x220 (Pair)	138

Kaleidoscope



Code	WxDxH (mm)	RRP (£)
COMBI	800x600x1900 (White Only)	336
COMBIDOOR	396x18x715 (Pair)	209
COMBIDRAWER	800x18x220 (Pair)	138



	Code	WxDxH (mm)	RRP (£)
HD 	COMBI	800x600x1900 (White Only)	336
	COMBIDOOR	396x18x715 (Pair)	229
	COMBIDRAWER	800x18x220 (Pair)	152
			
Urban 	UCOMBI	800x600x1900 (White Only)	336
	UCOMBIDOOR	396x18x715 (Pair)	209
	UCOMBIDRAWER	800x18x220 (Pair)	138

Universal Storage Internals/Accessories

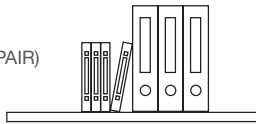
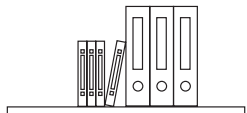
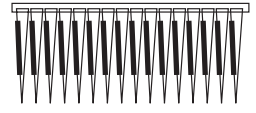
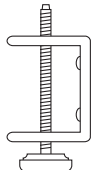
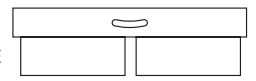
CODE SF	25mm WOODEN SHELF (PAIR)		RRP(£) 52	CODE SS	STEEL SHELF (BLACK) Not suitable for 800 mm wide units		RRP(£) 52
LF	LATERAL FILING FRAME (BLACK STEEL) Not suitable for 800 mm wide units		55	CHA	CABINET HEIGHT ADJUSTER/FOOT LEVELLER (RETRO FIX PACK - SELF ASSEMBLY)		21
POF	PULL OUT FILING FRAME (BLACK STEEL) Not suitable for 800 mm wide units		123				



Bookcases

Bookcase

18mm MFC Solid Back Panel & 25mm MFC Shelves

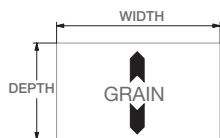

Code	WxDxH (mm)	RRP (£)
BK84	800x350x730 (1 MFC SHELF)	244
BK73	1056x350x730 (1 MFC SHELF)	252
BK12	1056x350x1200 (2 MFC SHELVES)	286
BK16	1056x350x1600 (3 MFC SHELVES)	325
BK19	1056x350x1900 (4 MFC SHELVES)	336

REFLECTIONS (white carcass)

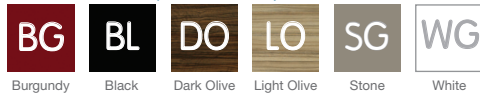

KALEIDOSCOPE (white carcass)

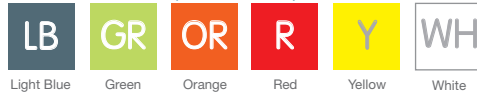

HD (white carcass)



URBAN (white carcass)

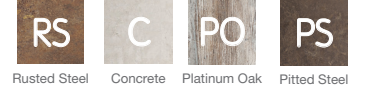

Filing Cabinets

Sylvan	Code	WxDxH (mm)	RRP (£)
 	SIF8	800x600x730 (Woodgrain Carcass)	463
<p>Reflections</p> 	RSIF8	800x600x730 (White Carcass)	479
<p>Kaleidoscope</p> 	SIF8	800x600x730 (White Carcass)	479
<p>HD</p> 	SIF8	800x600x730 (White Carcass)	479
<p>Urban</p> 	USIF8	800x600x730 (White Carcass)	479
<p>Sylvan</p>  	FC2 FC3 FC4	475x600x730 (2 DRAWER) 475x600x1025 (3 DRAWER) 475x600x1350 (4 DRAWER) (Woodgrain Carcass on all)	348 400 467
<p>Reflections</p> 	RFC2 RFC3 RFC4	475x600x730 (2 DRAWER) 475x600x1025 (3 DRAWER) 475x600x1350 (4 DRAWER) (White Carcass on all)	358 412 484



Kaleidoscope



Code

WxDxH (mm)

RRP (£)

FC2
FC3
FC4

475x600x730 (2 DRAWER)
475x600x1025 (3 DRAWER)
475x600x1350 (4 DRAWER)
(White Carcass on all)

358
412
484

HD



FC2
FC3
FC4

475x600x730 (2 DRAWER)
475x600x1025 (3 DRAWER)
475x600x1350 (4 DRAWER)
(White Carcass on all)

372
458
521

HD



UFC2
UFC3
UFC4

475x600x730 (2 DRAWER)
475x600x1025 (3 DRAWER)
475x600x1350 (4 DRAWER)
(White Carcass on all)

358
412
484



Credenza Units

Sylvan

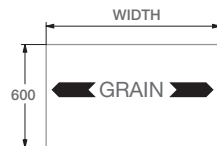

SU12
SU16

1200x600x730 (1 SHELF)
1600x600x730 (1 SHELF)
(Woodgrain Carcass on all)

494
594

Reflections



RSU12
RSU16

1200x600x730 (1 SHELF)
1600x600x730 (1 SHELF)
(White Carcass on all)

516
624

Kaleidoscope



SU12
SU16

1200x600x730 (1 SHELF)
1600x600x730 (1 SHELF)
(White Carcass on all)

516
624



170 degree hinge

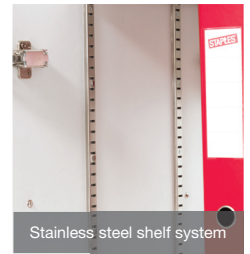

Stainless steel shelf system



Unique door catch System



Levelling feet as standard

STORAGE WALL

- Extensive range of finishes and combinations
- Minimum hassle with Bluespot installation teams
- Short lead times
- We welcome bespoke designs to compliment your scheme
- Free design consultancy available on request

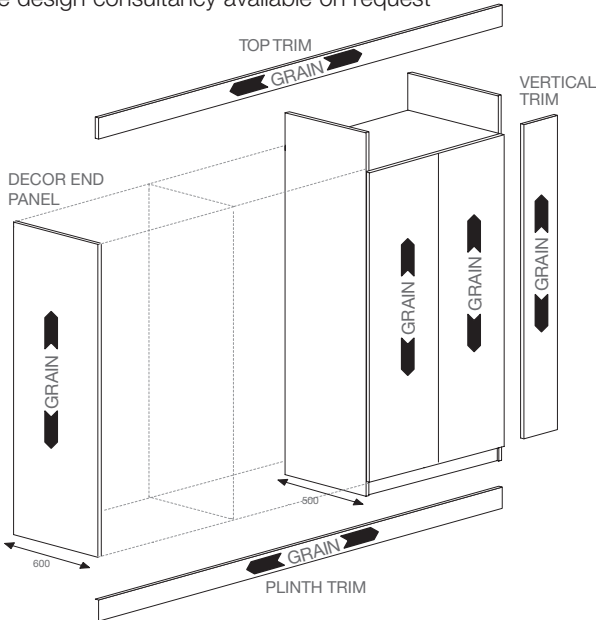

Design and project quotations available within 24 hours

Module Guide Price

W1000mm x H2400 Module
1x Decor End Panel, Plinth Trim, Top Trim,
Vertical Trim, 4 MFC Shelves

Total RRP
£1516
per module
+15% install available



Code	W(per bay)xH	RRP (£)
Storage wall height 1900mm-2400mm		
SW5001900-2400	500x1900-2400	933
SW10001900-2400	1000x1900-2400	1066
Storage wall height 2400mm-2900mm		
SW5002400-2900	500x2400-2900	977
SW10002400-2900	1000x2400-2900	1117
Decor back panels		
SWDBP5001900-2400	500x1900-2400	204
SWDBP10001900-2400	1000x1900-2400	275
SWDBP5002400-2900	500x2400-2900	217
SWDBP10002400-2900	1000x2400-2900	298
Decor end panel		
SWDEP1900-2400	600x1900-2400	214
SWDEP2400-2900	600x2400-2900	234
Top trims		
SWIT500	500mm L length	30
SWIT1000	1000mm Length	45
Includes fixing clips		
Plinth trims		
SWPT500	500mm Length	30
SWPT1000	1000mm Length	45
Includes fixing clips		
Vertical infill trims		
SWVIT1900-2400	1900-2400x250	30
SWVIT2400-2900	2400-2900x250	45
Includes fixing clips		

Storage Wall Internals/ Accessories

CODE	DESCRIPTION	RRP (£)	CODE	DESCRIPTION	RRP (£)
SWSF500	500mm WOODEN SHELF	23	SWSS	STEEL SHELF (BLACK)	67
SWSF1000	1000mm WOODEN SHELF	29		1000mm WIDE ONLY	
SWLF	LATERAL FILING FRAME (BLACK STEEL)	67	SWCR500	500mm WIDE COAT RAIL	29
	1000mm WIDE ONLY		SWCR1000	1000mm WIDE COAT RAIL	34
SWPOF	PULL OUT FILING FRAME (BLACK STEEL)	123	SWMK	MASTER KEY (STORAGE WALL)	17
	1000MM WIDE ONLY				

SCREENS



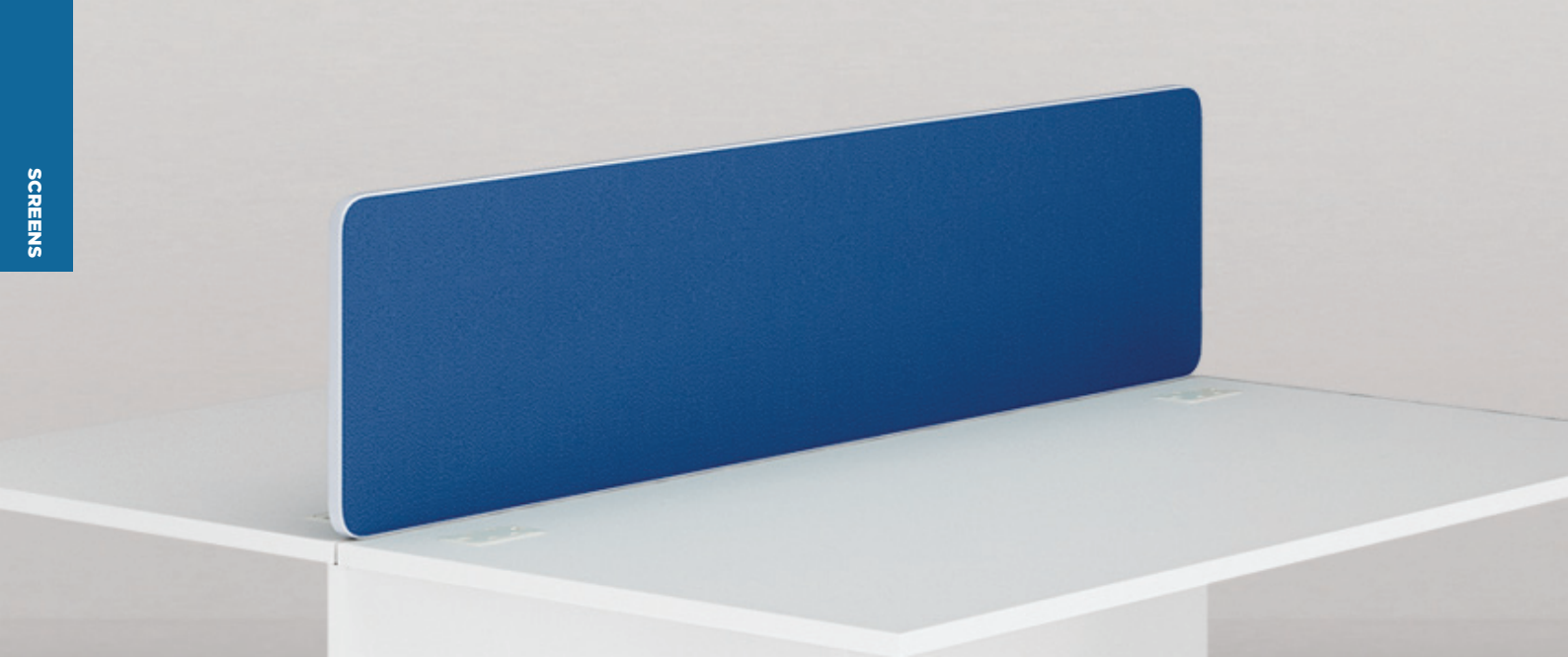

ECONOMY SCREENS

Manufactured from a re-cycled substrate with a durable silver finish edge trim and available in a choice of fabrics.

	Code	WxDxH (mm)	RRP (£)
Straight 400H 	DMSS8040*	800x30x400	142
	DMSS10040	1000x30x400	149
	DMSS12040*	1200x30x400	158
	DMSS14040	1400x30x400	165
	DMSS16040	1600x30x400	173
	DMSS18040	1800x30x400	181
	Wave 200-400H 	DMWS8040*	800x30x200-400
DMWS10040		1000x30x200-400	158
DMWS12040*		1200x30x200-400	165
DMWS14040		1400x30x200-400	173
DMWS16040		1600x30x200-400	181
DMWS18040		1800x30x200-400	189

Spigot or clamp fixing option. Please specify when ordering.



CF= CLAMP FIXING

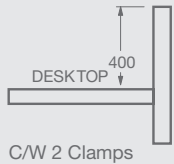

SF= SPIGOT FIXING

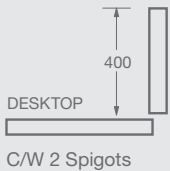

Silver & White trim options are available



Fabric Flammability
Conforms to BS 476
Part 7 Class 1

*Can be used as return screens for 800mm deep desks or 1200mm workstations. Clamp fitting only.

COLOUR OPTIONS

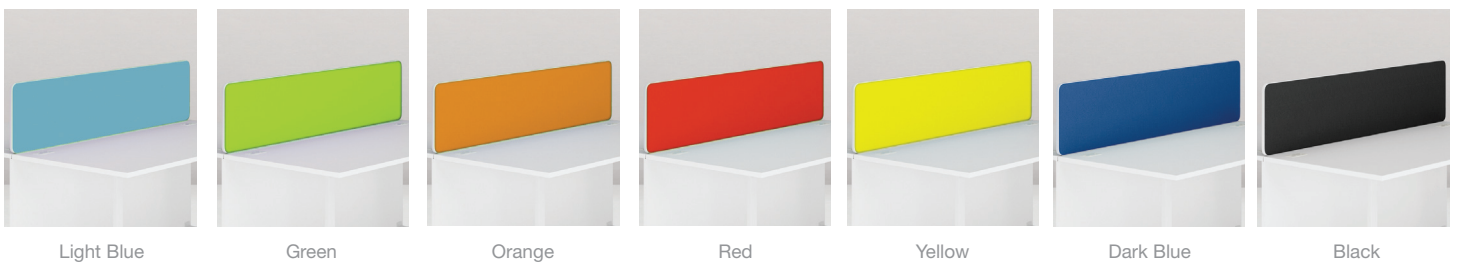

Light Blue

Green

Orange

Red

Yellow

Dark Blue

Black

ALUMINIUM SCREENS



Silver Frame



White Frame

*Silver or white frame option - please specify when ordering (Code - SIL = Silver Frame, Code - WHI = White Frame) e.g ALU1240WHILB (Light Blue)

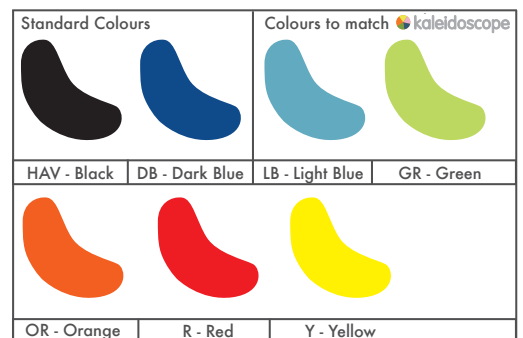

Return screens and non standard fabrics available - ask for details

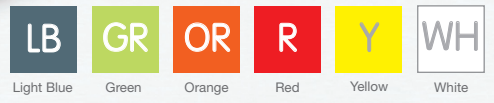

Code	WxDxH (mm)	RRP (£)	Code	WxDxH (mm)	RRP (£)
Fabric			Tool Rail Accessories		
ALU8040	800x25x400	149	MONARM3	Tool Rail Fixing Monitor Arm	175
ALU1040	1000x25x400	160	PMTRAY	A4 paper tray available in silver & white	65
ALU1240	1200x25x400	172	PEN-POT	Pen pot tray available in silver & white	49
ALU1440	1400x25x400	182	Acrylic		
ALU1640	1600x25x400	191	ALUAC8040	800x25x400	248
ALU1840	1800x25x400	199	ALUAC1040	1000x25x400	265
Fabric c/w Tool Rail			ALUAC1240	1200x25x400	280
ALUTR8040	800x25x400	199	ALUAC1440	1400x25x400	297
ALUTR1040	1000x25x400	217	ALUAC1640	1600x25x400	312
ALUTR1240	1200x25x400	237	ALUAC1840	1800x25x400	326
ALUTR1440	1400x25x400	253	Acrylic c/w Tool Rail		
ALUTR1640	1600x25x400	269	ALUTRAC8040	800x25x400	297
ALUTR1840	1800x25x400	284	ALUTRAC1040	1000x25x400	321
Fabric & Pinnable			ALUTRAC1240	1200x25x400	345
ALUPIN8040	800x25x400	195	ALUTRAC1440	1400x25x400	351
ALUPIN1040	1000x25x400	212	ALUTRAC1640	1600x25x400	390
ALUPIN1240	1200x25x400	224	ALUTRAC1840	1800x25x400	411
ALUPIN1440	1400x25x400	239	Linking Bracket		
ALUPIN1640	1600x25x400	247	LINK2WAY	2 way - Straight run	5
ALUPIN1840	1800x25x400	262	LINK2WAY90	2 way - 90 Degree	5
Fabric & Pinnable c/w Tool Rail			LINK2WAY120	2 way - 120 Degree	5
ALUTRPIN8040	800x25x400	244	LINK3WAY	3 way	10
ALUTRPIN1040	1000x25x400	268	LINK3WAY90	3 way - 90 Degree	10
ALUTRPIN1240	1200x25x400	289	LINK3WAY120	3 way - 120 Degree	10
ALUTRPIN1440	1400x25x400	310	LINK4WAY	4 way	15
ALUTRPIN1640	1600x25x400	325			
ALUTRPIN1840	1800x25x400	347			



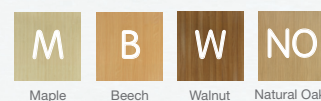

Colour Curved Reception Desk

	Description	Code	WxDxH (mm)	RRP (£)
 <p>Rectangular Reception Desk - Starter Unit</p>	STARTER UNIT	RDC1600	1600x800x730 (excludes shelf)	499
	GLASS SHELF	RDCGS	1600x350x10	457
	MFC SHELF	RDCSF	1600x350x25	172
 <p>Curved Reception Corner Unit</p>	CORNER UNIT	RDCCU800	800x800x1130	599
 <p>Return Rectangular Reception Desk</p>	RETURN UNIT	RDCR1000	1000x800x1130	499



Curved Reception Desk

	Description	Code	WxDxH (mm)	RRP (£)
	Rectangular Reception Desk - Starter Unit			
	STARTER UNIT	RDC1600	1600x800x730 (excludes shelf)	499
	GLASS SHELF MFC SHELF	RDCGS RDCSF	1600x350x10 1600x350x25	457 172
	Curved Reception Corner Unit			
	CORNER UNIT	RDCCU800	800x800x1130	599
	Return Rectangular Reception Desk			
	RETURN UNIT	RDCR1000	1000x800x1130	499



Terms & Conditions

1. APPLICATION

1.1 These Conditions alone shall govern and be incorporated in every contract for the sale of goods made by or on behalf of Bluespot Furniture Ltd. ("the Seller") with any customer ("the Buyer"). They shall apply in place of and prevail over any terms or conditions, (whether or not in conflict or inconsistent with these Conditions), contained or referred to in any documentation submitted by the Buyer or in correspondence or elsewhere or implied by trade, custom, practice or course of dealing unless specifically excluded or varied in writing by a director or other authorised representative of the Seller and any purported provisions to the contrary are hereby excluded or extinguished.

1.2 Acceptance by the Buyer of delivery of the goods shall (without prejudice to Condition 2 or any other manner in which acceptance of these Conditions may be evidenced) be deemed to constitute unqualified acceptance of these Conditions.

1.3 If, subsequent to any contract of sale which is subject to these Conditions, a contract of sale is made with the same buyer without reference to any conditions of sale or purchaser such contract howsoever made shall be deemed to be subject to these Conditions.

2. QUOTATIONS AND ACCEPTANCE

2.1 A quotation by the Seller does not constitute an offer and the Seller reserves the right to withdraw or revise the same at any time prior to the Seller's acceptance of the Buyer's order.

2.2 The Seller's acceptance of the Buyer's order (including telephone orders) shall be effective only when confirmed verbally or in writing by the Seller.

2.3 The Buyer may not cancel any order once accepted by the Seller without the written consent of the Seller and the Buyer will in any event be liable to the Seller for all expenses or loss (including loss of profit) incurred by the Seller in relation to any such cancellation.

3. PRICES

3.1 The prices payable for the goods shall be those set out in the Seller's list prices current at the time of despatch or in accordance with any indication given verbally or in writing by the Seller from time to time. The Seller shall have the right at any time to withdraw any discount from its normal prices and/or to revise prices to take account of inflation and/or increases in costs including (without limitation) costs of any goods materials carriage labour or overheads the increase or imposition of any tax duty or other levy and any variation in exchange rates.

3.2 Unless otherwise specified VAT and any other tax or duties payable by the Buyer shall be added to the price.

3.3 Any discount allowed to the Buyer shall be notified to the Buyer from time to time.

3.4 Unless otherwise stated origination expenses (including the cost of acquiring or adapting machinery to the Buyer's manufacturing requirements) shall be added to the price and may be charged separately prior to delivery of the goods.

3.5 Installation is not included in prices unless specifically stated.

4. TERMS OF PAYMENT

4.1 Payment of invoices shall unless otherwise agreed in writing be made in full without any deduction or set-off within 30 days of the date of the invoice. Time of payment shall be of the essence of all contracts between the Buyer and the Seller to which these Conditions apply. The Seller reserves the right to suspend the provision of goods to the Buyer where any amounts are overdue under any contract with the Buyer until all such amounts have been paid.

4.2 Any extension of credit allowed to the Buyer may be changed or withdrawn at any time.

4.3 Interest shall be payable on overdue accounts at the rate of 5% over National Westminster Bank PLC base rate from time to time to run from the due date for payment until receipt by the Seller of the full amount whether before or after judgment.

4.4 If in the opinion of the Seller the credit-worthiness of the Buyer shall have deteriorated prior to delivery of the goods the Seller may require full or partial payment of the price prior to such delivery or the provision of security for payment by the Buyer in a form acceptable to the Seller.

4.5 Notwithstanding any purported contrary apportionment by the Buyer all payments made by the Buyer to the Seller shall be apportioned first to goods which have been re-sold by the Buyer and then to goods which remain in the possession or under the control of the Buyer.

5. DELIVERY

5.1 Delivery or despatch dates mentioned in any quotation, order acceptance form or elsewhere are approximate only and not of any contractual effect and the Seller shall not be under any liability to the Buyer in respect of any failure to deliver on any particular date or dates. Time for delivery shall not be of the essence of any contract to which these Conditions apply and shall not be made so by the service of any notice.

5.2 Delivery shall be at the Buyer's premises unless otherwise stipulated or agreed by the Seller. The cost of delivery shall be included in the price but the Seller shall make an additional charge for delivery in the United Kingdom otherwise than by its normal carrier or for express delivery. Unless agreed in writing the Buyer shall unload and inspect the goods immediately on their arrival at the Buyer's premises. The Buyer shall indemnify the Seller against any and all claims liabilities costs or expenses arising as a result of the Seller or its sub-contractors assisting the Buyer in the unloading, loading or other removal of the goods from the point of delivery.

5.3 If the Buyer refuses or fails to take delivery of goods tendered in accordance with the contract or fails to take any action necessary on its part for delivery and/or shipment of the goods the Seller shall be entitled to terminate the contract with immediate effect, to dispose of the goods as the Seller may determine, and to recover from the Buyer any loss and additional costs incurred as a result of such refusal or failure (including without limitation storage costs from the due date of delivery).

5.4 Unless otherwise expressly agreed the Seller may effect delivery in one or more instalments. Where delivery is effected by instalments each instalment shall be treated as a separate contract governed by these Conditions.

5.5 Section 32(2) of the Sale of Goods Act 1979 shall not apply. The Seller shall not be required to give the Buyer the notice specified in Section 32(3) of that Act.

6. RISK

6.1 Risk in the goods shall immediately pass to the Buyer upon delivery of the goods into the custody, care or control of the Buyer or its warehouse men, bailees or agents or to the carriers and the Buyer thereafter shall be responsible for all claims, actions and losses arising out of or in any way associated with the goods.

6.2 Any property of the Buyer in or under the Seller's possession or control and all property supplied to the Seller on behalf of the Buyer shall be held by the Seller at the Buyer's risk.

6.3 From the time of delivery until property in the goods passes to the Buyer in accordance with Condition 7 the Buyer shall insure the goods for their full value with a reputable insurance company. Upon request, the Buyer shall use reasonable endeavours to have the Seller's interest in the goods noted on the insurance policy. Until property in the goods passes to the Buyer the Buyer shall hold the proceeds of any claim on such insurance policy on trust for the Seller and shall forthwith account to the Seller with such proceeds.

7. TITLE

7.1 Notwithstanding delivery and passing of risk, the goods shall remain the property of the Seller until such time as the Buyer shall have paid to the Seller the agreed price (together with any accrued interest) and all other amounts owed by the Buyer to the Seller in respect of any other contract for the sale of goods.

7.2 Until property in the goods has passed the Buyer shall be in possession of the goods in a fiduciary capacity and shall:-

- (a) not part with possession of the goods otherwise than in accordance with Condition 7.6;
- (b) take proper care of the goods and take all reasonable steps to prevent any damage to or deterioration of them;
- (c) keep the goods free from any charge, lien or other encumbrance and store the goods in such a way to show clearly that they belong to the Seller;
- (d) notify the Seller forthwith upon the happening of any of the events set out in Condition 17.1; and
- (e) give the Seller such information relating to the goods as the Seller may from time to time require.

7.3 The Seller reserves the right to repossess and re-sell any goods to which it has retained title and the Seller's consent to the Buyer's possession of the goods and any right the Buyer may have to possession of the goods shall in any event cease:-

- (a) if any sum owed by the Buyer to the Seller (whether in respect of the goods or otherwise) is not paid to the Seller by the date when it is due; or
- (b) upon the happening of any of the events set out in Condition 17.1; or
- (c) if the Buyer commits a breach of any contract with the Seller.

7.4 The Buyer hereby grants an irrevocable right and licence to the Seller and its servants and agents to enter upon all or any of the Buyer's premises with or without vehicles during normal business hours for the purpose of inspecting and/or re-possessing goods to which it has retained title. This right and licence shall continue to subsist notwithstanding the termination for any reason of any contract which is subject to these Conditions and is without prejudice to any accrued rights of the Seller under such contracts or otherwise.

7.5 The Buyer is licensed by the Seller to process goods to which the Seller has retained title in such fashion as it may wish and/or to incorporate them in or with any other products subject to the express condition that the new product or products or any other chattel whatsoever containing any part of the said goods shall become the property of the Seller and shall be separately stored and marked by the Buyer to show clearly that they belong to the Seller. The Seller shall hold the new product or products as trustee for itself and the Buyer and the Seller's interest as a beneficiary of the trust shall be equal to the total of all amounts owing by the Buyer to the Seller under any contract for the sale of goods.

7.6 Whilst the Buyer is in possession of the goods with the Seller's consent (but not otherwise) the Buyer may in the ordinary course of its business sell or hire the goods or any new product or products produced with the Seller's goods provided that:-

- (a) as between the Buyer and its sub-buyer or customer the Buyer shall sell or hire the goods as principal and the Buyer shall not and shall not be empowered to commit the Seller to any contractual relationship with or liability to the sub-buyer or customer or any other person;
- (b) as between the Seller and the Buyer, the Buyer shall sell or hire the goods in a fiduciary capacity as agent for the Seller; and
- (c) notwithstanding any agreed period of credit for payment of the price of the goods the Buyer shall pay the proceeds of such sales or hiring to the Seller forthwith upon receipt.

The Buyer acknowledges that as a consequence of its fiduciary relationship with the Seller it is under a common law duty to the Seller to hold the proceeds of any such sales or hiring on trust for the Seller and not to mingle such proceeds with any other monies or pay them into an overdraft bank account, such common law duty being unaffected by and wholly independent of the terms of these Conditions.

7.7 The Buyer agrees immediately upon being so requested by the Seller to assign to the Seller all rights and claims which the Buyer may have against its sub-buyers or customers arising from such sales or hiring until payment is made in full as stated above.

7.8 Notwithstanding the provisions of this Condition 7 the Seller shall be entitled to bring an action against the Buyer for the price of the goods in the event of non-payment by the Buyer by the due date even though property in the goods has not passed to the Buyer and/or shall have the right by notice to the Buyer at any time after delivery to pass property in the goods to the Buyer as from the date of such notice.

8. INSTALLATION

8.1 If goods are installed by the Seller the Buyer must allow the Seller reasonable unrestricted access for such installation during normal working hours or as specified in the particular contract.

8.2 The Seller may pass on to the Buyer any reasonable additional expenses or charges incurred through the Buyer's failure to provide unimpeded access or accurate information regarding the premises where goods are to be installed.

9. VARIATIONS IN QUANTITY

The Seller shall be deemed to have fulfilled its contractual obligations in respect of any delivery even though the quantity may be up to 10% more or less than the quantity specified in the contract and in such event the Buyer shall pay for the actual quantity delivered.

10. THIRD PARTY RIGHTS

10.1 The Buyer shall indemnify the Seller against any and all claims liabilities costs and expenses incurred by or made against the Seller as a direct or indirect result of the carrying out of any work required to be done on or to the goods in accordance with the requirements or specifications of the Buyer involving any infringement or alleged infringement of any rights of any third party.

10.2 In respect of all other sales, if at any time any allegation of infringement of patent, copyright or design rights is made in respect of the goods or if in the Seller's reasonable opinion such an allegation is likely to be made, the Seller may at its option and at its own expense:-

(a) modify or replace the goods without detracting from overall performance thereof, so as to avoid the infringement; or

(b) procure for the Buyer the right to continue to use the goods; or

(c) re-purchase the goods at the price paid by the Buyer less depreciation at such rate as is applied by the Seller to its own equipment.

10.2 In respect of all other sales, if at any time any allegation of infringement of patent, copyright or design rights is made in respect of the goods or if in the Seller's reasonable opinion such an allegation is likely to be made, the Seller may at its option and at its own expense:-

(a) modify or replace the goods without detracting from overall performance thereof, so as to avoid the infringement; or

(b) procure for the Buyer the right to continue to use the goods; or

(c) re-purchase the goods at the price paid by the Buyer less depreciation at such rate as is applied by the Seller to its own equipment.

10.3 The Buyer shall notify the Seller forthwith of any claim made or action brought or threatened alleging infringement of the rights of any third party. The Seller shall have control over and shall conduct any such proceedings in such manner as it shall determine. The Buyer shall provide all such reasonable assistance as the Seller may request. The cost of any such proceedings shall be borne in such proportions as the parties shall determine.

10.4 Where the Seller or its employees or agents design the goods pursuant to a commission from the Buyer (whether in consideration of an order or otherwise) then any copyright or design rights created in relation to the goods shall vest in the Seller and the Buyer agrees that it shall do any acts and execute any documentation required by the Seller to secure vesting of title to such copyright or design rights to the Seller.

11. LIABILITY

11.1 The Seller shall not be liable to the Buyer:-

(a) for non-delivery unless a written claim is received by the Seller within 3 days from the date of the Seller's invoice or advice note, whichever is the earlier;

(b) for shortages in quantity delivered in excess of those permitted by condition 9 unless the Buyer notifies the Seller of any claim for short delivery within 3 days of receipt of any goods;

(c) for damage to or loss of the goods or any part of them in transit (where the goods are carried by the Seller's own transport or by a carrier on behalf of the Seller) unless the Buyer shall notify the Seller of any such claim within 3 days of receipt of the goods or the scheduled date of delivery whichever shall be the earlier;

(d) for defects in the goods caused by fair wear and tear, abnormal or unsuitable conditions or storage or use or any act, neglect or default of the Buyer or of any third party;

(e) for other defects in the goods unless notified to the Seller within 7 days of receipt of the goods by the Buyer or where the defect would not be apparent on reasonable inspection within 3 months of delivery.

11.2 Where liability is accepted by the Seller under Condition 11.1 the Seller's only obligation shall be at its option to make good any shortage or non-delivery and/or as appropriate to replace or repair any goods found to be damaged or defective and/or to refund the cost of such goods to the Buyer.

11.3 The Seller shall not be liable for any loss, damage or liability of any kind suffered by any third party directly or indirectly caused by repairs or remedial work carried out without the Seller's prior written approval and the Buyer shall indemnify the Seller against any and all claims and costs arising out of such claims to the extent that such repairs or remedial work have been performed by the Buyer or its agents.

11.4 The Seller's aggregate liability to the Buyer whether for negligence, breach of contract, misrepresentation or otherwise shall in no circumstance exceed the cost of the defective, damaged or undelivered goods which give rise to such liability (as determined by net price invoiced to the Buyer) in respect of any occurrence or series of occurrences.

11.5 Subject to this condition 11:-

(a) all conditions warranties and representations expressed or implied by statute common law or otherwise in relation to the goods are hereby excluded;

(b) the Seller shall be under no liability to the Buyer for any loss damage or injury, direct or indirect, resulting from defects in design, materials or workmanship or otherwise howsoever arising (and whether or not caused by the negligence of the Seller its employees or agents);

(c) the Seller shall have no liability for any indirect or consequential losses or expenses suffered by the Buyer, howsoever caused, and including without limitation loss of anticipated profits, goodwill, reputation, business receipts or contracts, or losses or expenses resulting from third party claims.

11.6 The Seller's prices are determined on the basis of the limits of liability set out in this Condition. The Buyer may by written notice to the Seller request the Seller to agree a higher limit of liability provided insurance cover can be obtained for such higher limit. The Seller shall effect insurance up to such limit and the Buyer shall pay upon demand the amount of any and all premiums. The Buyer shall disclose such information as the insurers shall require. In no case shall the Buyer be entitled to recover from the Seller more than the amount received from the insurers.

12. SPECIFICATIONS AND CONFIDENTIALITY

12.1 Unless expressly agreed in writing by the Seller all drawings, designs, specifications and particulars of weights and dimensions submitted by the Seller are approximate only and the Seller shall have no liability in respect of any deviation from them.

12.2 The Seller accepts no responsibility for any errors omissions or other defects in any drawings, designs or specifications not prepared by the Seller and the Seller shall be indemnified by the Buyer against any and all claims liabilities costs and expenses incurred by the Seller arising from them.

12.3 Corrections to goods required by the Buyer following inspection and approval of proofs by the Buyer shall be at the Buyer's expense and will be charged for separately.

12.4 All drawings, designs, specifications and information submitted by the Seller shall be treated as confidential and shall not be disclosed to any third party without the Seller's written consent or used by the Buyer other than for purposes authorised by the Seller.

12.5 The Seller reserves the right to make without notice any changes in materials specifications or design of the goods which having regard to all circumstances it considers to be reasonable or desirable but which do not affect the operational requirements of the goods and such changes shall not affect the validity of the contract.

13. PACKAGING

13.1 The Buyer shall meet the cost of any special packaging requested by the Buyer or any packaging rendered necessary by delivery by any means other than the Seller's normal means of delivery. The Buyer shall unless otherwise agreed be solely responsible for the disposal of all packaging in accordance with all regulations (whether statutory or otherwise) relating to the protection of the environment.

13.2 The Seller shall be entitled to invoice the Buyer for the cost of all pallets and other returnable packaging material unless the same are returned to the Seller in good condition carriage paid within 30 days of the date of delivery.

14. LICENCES AND CONSENTS

If any licence or consent of any government or other authority shall be required for the acquisition, carriage or use of the goods by the Buyer the Buyer shall obtain the same at its own expense and if requested produce evidence of the same to the Seller on demand. Failure to obtain any licence or consent shall not entitle the Buyer to withhold or delay payment of the price. Any additional expenses or charges incurred by the Seller resulting from such failure shall be for the Buyer's account.

15. FORCE MAJEURE

15.1 The Seller shall not be liable to the Buyer for any loss or damage which may be suffered by the Buyer as a direct or indirect result of the supply of goods by the Seller being prevented hindered delayed cancelled or rendered uneconomic by reason of circumstances or events beyond the Seller's reasonable control ("force majeure circumstances") including but not limited to acts of God war riot strike lock-out trade dispute or labour disturbance accident break-down of plant or machinery fire flood storm difficulty or increased expense in obtaining workmen materials or transport or other circumstances affecting the supply of the goods or of raw materials by the Seller's normal source of supply or the manufacture of the goods by the Seller's normal means or the delivery of the goods by the Seller's normal route or means of delivery.

15.2 In force majeure circumstances the Seller may in its sole discretion terminate any contract for the supply of goods pursuant to these Conditions or cancel delivery of goods to the Buyer or may, with the agreement of the Buyer, deliver goods at an agreed rate of delivery commencing after any suspension of deliveries.

15.3 If due to force majeure circumstances the Seller has insufficient stocks to meet all its commitments the Seller may apportion available stocks between its customers at its sole discretion.

16. SAMPLES

Any samples supplied to the Buyer are supplied solely for information and in no way import any express or implied conditions or warranties as to quality, description, fitness for purpose or merchantable quality and the Buyer shall be deemed to have satisfied itself as to such matters prior to ordering the goods.

17. TERMINATION

17.1 If the Buyer (being an individual) enters into a voluntary arrangement or if a petition is presented for the making of a bankruptcy order against him or if he compounds with his creditors or if (being a company) an application for an order is made or a resolution is passed for the winding-up of the Buyer otherwise than for the purposes of amalgamation or reconstruction (previously approved in writing by the Seller) or if a meeting is called to approve the appointment of a liquidator to the Buyer or if a petition is presented to the Court for the appointment of a liquidator to the Buyer or if a receiver, manager, administrative receiver or administrator is appointed or a petition is presented to the Court for an appointment of an administrator to the Buyer or over any part of the Buyer's undertaking or if circumstances arise which might entitle the Court or a creditor of the Buyer to appoint a receiver, manager, administrative receiver or administrator or which might entitle the Court to make a winding-up order or if the Buyer takes or suffers any similar or analogous action in consequence of debt or commits a breach of any contract between the Seller and the Buyer the Seller may without prejudice to any of its other rights stop any goods in transit and/or suspend further deliveries to the Buyer and/or exercise its rights under Condition 7 and/or by notice in writing to the Buyer terminate any contract with the Buyer.

17.2 Upon termination of any contracts pursuant to Condition 17.1 any indebtedness of the Buyer to the Seller shall become immediately due and payable and the Seller shall be relieved of any further obligation to supply any goods to the Buyer pursuant to such contracts.

18. ASSIGNMENT

None of the rights or obligations of the Buyer under these Conditions may be assigned or transferred in whole or in part without the prior written consent of the Seller.

19. HEALTH AND SAFETY AT WORK ETC

The Buyer agrees to pay due regard to any information supplied by the Seller and relating to the use for which the goods are designed to have been tested or concerning conditions necessary to ensure that they will be safe and without risk to health at all times when they are being set, used, cleaned or maintained by any person at work, and the Buyer undertakes to take such steps as may be specified by the above information to ensure that as far as reasonably practicable the goods will be safe and without risks to health at all times as are mentioned above.

20. LIEN

The Seller shall be entitled to a general lien on all goods and property owned by the Buyer in the Seller's possession (although the Buyer may have paid for the same in full) in satisfaction of the whole or part as the case may be of the unpaid price of any goods sold and delivered to the Buyer under any contract. The Seller shall be entitled to offset any sum or sums owing to it from the Buyer against any sums owed by the Buyer to the Seller.

21. HEADINGS

The headings of these Conditions do not form part of the Conditions and shall not affect their interpretation.

22. NON-PERFORMANCE BY THE BUYER

The Seller reserves the right to cancel and/or delay performance of any contract in the event of material or persistent non-performance by the Buyer in relation to any contract between the Buyer and the Seller.

23. SEVERABILITY

If any of these Conditions are held to be invalid, illegal or unenforceable in any respect whether in whole or in part such invalidity, illegality or unenforceability shall not prejudice the effectiveness of the rest of these Conditions or the remainder of any part of a Condition affected.

24. WAIVER

Failure by the Seller to exercise or enforce any rights under any contract subject to these Conditions shall not be deemed to be a waiver of any such right nor operate so as to bar the exercise or enforcement of such right at any time thereafter.

25. NOTICES

Any notice hereunder shall be in writing and be deemed to have been duly given if delivered personally or sent by pre-paid first class post (airmail if to an address outside the United Kingdom) telex or telefax to the party concerned at its last known address. Notices delivered personally shall be deemed to have been given when delivered, notices sent by first class post shall be deemed to have been given seven days after despatch (fourteen days if given by airmail) and notices sent by telex or telefax shall be deemed to have been given on the date of despatch.

26. GOVERNING LAW

Any contract to which these Conditions apply shall be governed by and construed in accordance with the Laws of England and the parties hereby submit to the exclusive jurisdiction of the English Courts.



Bluespot Furniture Ltd

Unit 500

Bretton Park Way

Dewsbury

West Yorkshire WF12 9BS

Tel: 0844 800 9920

Fax: 0844 800 9921

sales@bluespotfurniture.co.uk

www.bluespotfurniture.com