

# MARCH

20  
25



**DESIGN.**  
**PRECISION.**  
**STYLE.**

**PERFORMANCE PULLEYS,  
BRACKETS, & ACCESSORIES**

SERPENTINE SYSTEMS, V-BELT KITS,  
PULLEYS, BRACKETS, BILLET AIR CLEANERS,  
HINGES, ULTRA ACCESSORIES & MORE.

# YOUR GUIDE TO EVERYTHING INSIDE. PRODUCTS FOR EVERY ENTHUSIAST.

**08**

## CHEVY

- 08 SMALL BLOCK
- 18 BIG BLOCK
- 24 LS
- 27 LT1 GEN V
- 28 LT1 GEN II
- 29 348 / 409
- 29 LATE MODEL & TRUCKS

**30**

## FORD

- 31 SMALL BLOCK
- 38 351 CLEVELAND
- 40 BIG BLOCK
- 41 3.8L & 4.6L
- 42 FE
- 43 COYOTE
- 43 FLATHEAD

**44**

## CHRYSLER

- 45 SMALL BLOCK
- 48 BIG BLOCK
- 50 HEMI 5.7 - 6.1 - 6.4
- 50 HEMI 392
- 51 DODGE MAGNUM
- 51 DODGE VIPER & SRT10

**52**

## PONTIAC

- 52 326 - 455

**55**

## CADILLAC

- 55 425, 475 - 500

**56**

## OLDSMOBILE

- 56 455 & 350 ROCKET

**57**

## BUICK

- 57 400 - 430 - 455
- 57 GRAND NATIONAL REGAL
- 57 3.8L
- 58 NAILHEAD

**59**

## AMC & JEEP

- 59 326 - 455

**60**

## MARCH ACCESSORIES

- 60 BILLET AIR CLEANERS
- 62 BILLET HOOD HINGES
- 64 BILLET TRUNK HINGES
- 65 SHIFT LEVERS
- 65 DOOR / WINDOW HANDLES
- 65 DOOR JAMB LOUVRES
- 66 ALTERNATORS
- 68 POWER STEERING PULLEYS
- 69 POWER STEERING PUMPS

- 70 POWER STEERING ACCESSORIES
- 71 -AN RADIATOR FITTINGS
- 71 RADIATOR SUPPORT BRACKETS
- 71 BEZELS / LIGHTS
- 72 WATER PUMPS
- 74 AN LINES
- 74 THERMOSTAT HOUSINGS
- 75 AC COMPRESSORS
- 75 VINTAGE AIR AC SYSTEMS

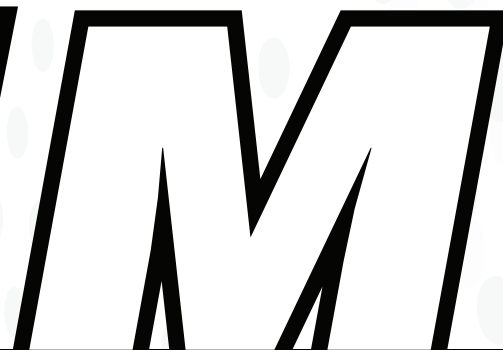

# M

**PERFORMANCE**

**DESIGN. PRECISION. STYLE.**

**OVER 30 YEARS OF BEING UNDER  
THE HOOD OF CARS AROUND THE WORLD.**

Our expertly trained & highly experienced staff is committed to helping our customers get the right product for their ride. All billet products are designed, developed, and manufactured in our 60,000 square foot facility in the heart of the midwest with superior styling and durability in mind.

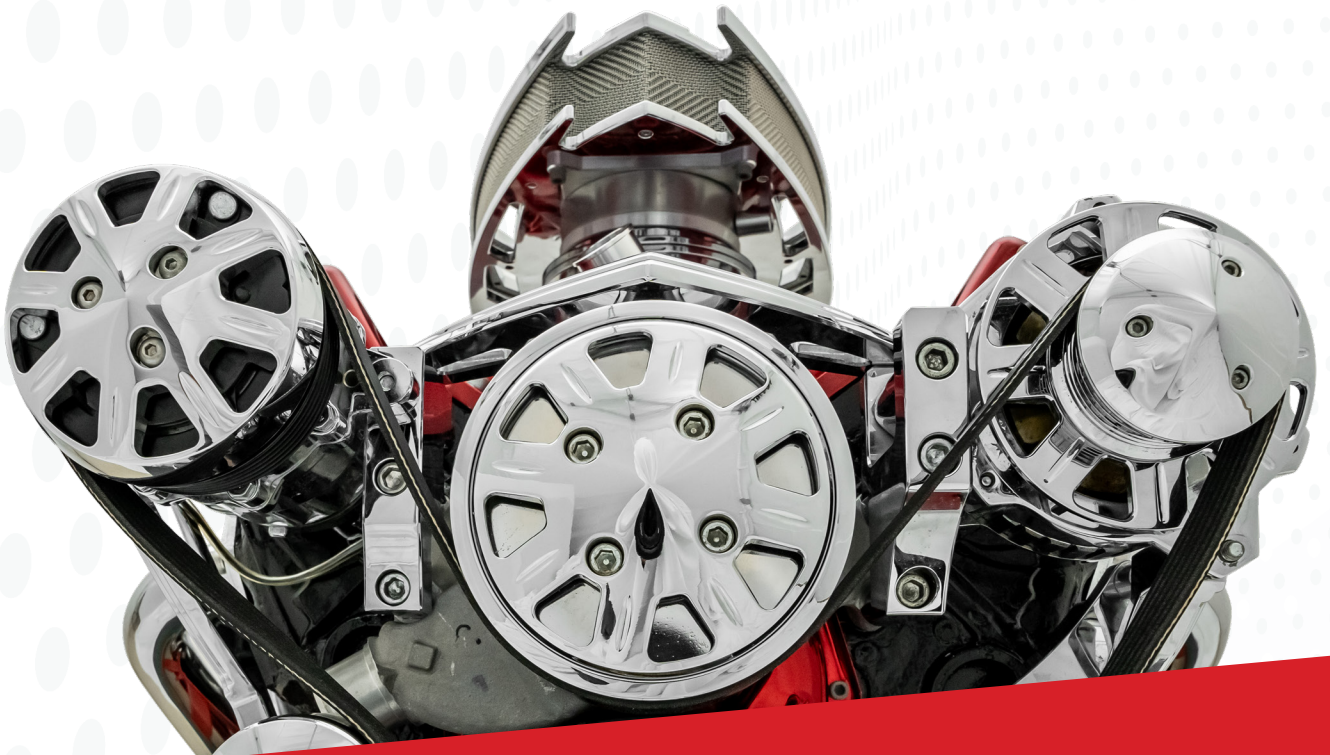

# MARCH KIT TYPES

EVOLUTION ALL INCLUSIVE

## EVOLUTION *NEW*



**KIT TYPES:** 8-Rib Serpentine.  
**KEY FEATURES:** A uniquely premiere modern style with intricate details throughout the design.  
**MAKES:** Chevy Small and Big Block, LS and Ford Small Block.

REVOLVER ALL INCLUSIVE

## Revolver

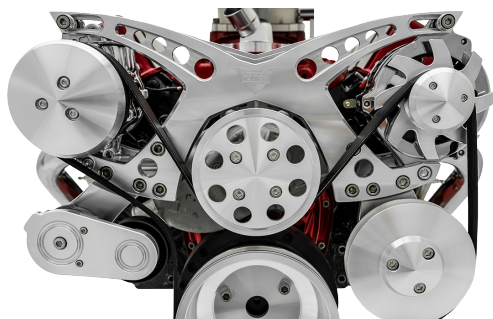

**KIT TYPES:** 6-Rib Serpentine.  
**KEY FEATURES:** Pocketed bracket design with matching covers. Compact and rigid design.  
**MAKES:** Chevy, Ford, Chrysler, and Pontiac.

SPORT TRACK ALL INCLUSIVE

## SPORT TRACK

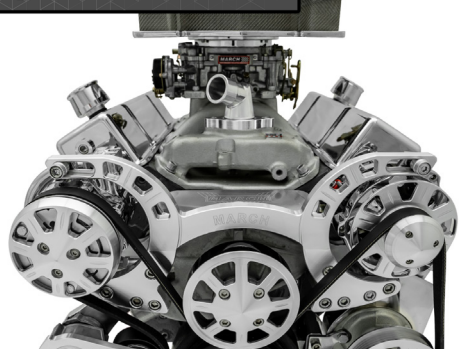

**KIT TYPES:** 6-Rib Serpentine.  
**KEY FEATURES:** Exceptionally styled bracket with matching pulleys. Compact, rigid design with adjustable tensioning.  
**MAKES:** Big and Small Block Chevy.

STYLE TRACK ALL INCLUSIVE

## Style TRACK

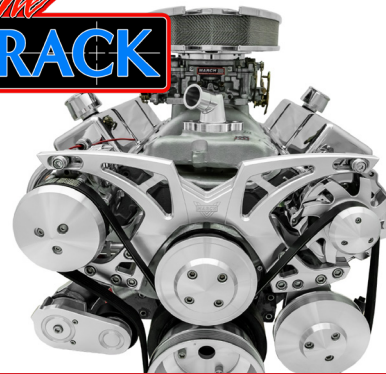

**KIT TYPES:** 6-Rib Serpentine.  
**KEY FEATURES:** March's distinctive trademark bracket styling. Compact and Rigid design with adjustable tensioning.  
**MAKES:** Chevy, Ford, Chrysler, Pontiac, Oldsmobile, and Buick.

ULTRA DRIVE ALL INCLUSIVE

## ULTRA DRIVE

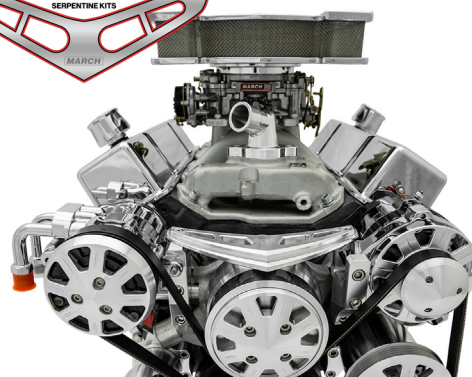

**KIT TYPES:** 6-Rib Serpentine.  
**KEY FEATURES:** The Ultimate show kit. Intricate showcase design with a look that has stood the test of time.  
**MAKES:** Big and Small Block Chevy.

CUSTOM SERIES ALL INCLUSIVE

## CUSTOM SERIES



**KIT TYPES:** 6-Rib Serpentine  
**KEY FEATURES:** Style meets value. March classic designs in budget friendly packages.  
**MAKES:** Chevy Small and Big block, Chevy LS.

# MA

# MARCH FINISH TYPES

## CHOOSE FROM 4 POWDER COAT FINISHES

CLEAR

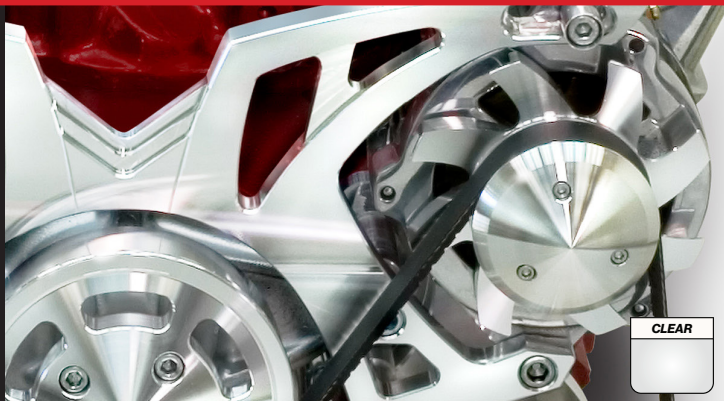

BLACK

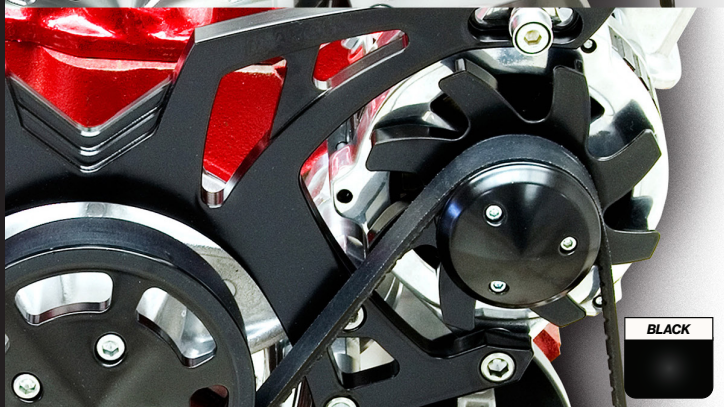

CHROME

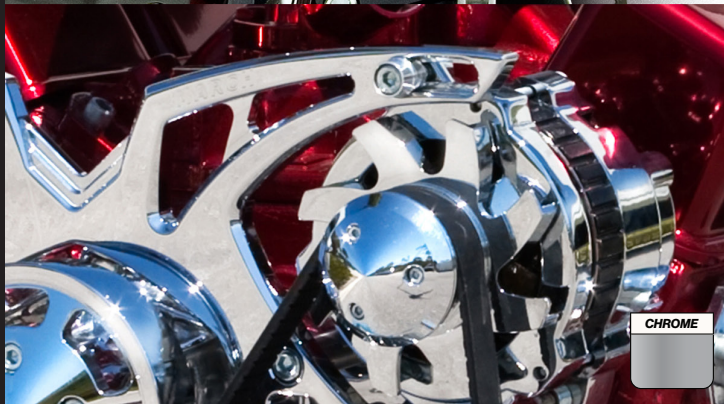

BLACK ONYX



# MARCH

### No Maintenance Required. **Period.**

March Performance's Billet Aluminum Pulleys, Brackets, and Air Cleaners come in a variety of powder-coat finishes. Our finishes are done in a powder-coat format that protects the billet aluminum from weather oxidation and removes the need to polish for high shine, creating a beautiful look with no maintenance required.

#### **MARCH CLEAR**

**OVERVIEW:**

Our standard signature finish. A simple clear powder-coat finish over our machine finished billet aluminum, high shine with no polishing required.

**AVAILABILITY:**

In Stock, No Wait.

#### **MARCH BLACK**

**OVERVIEW:**

A simple, but premium, black powder-coat finish that allows for a more modern or factory look.

**AVAILABILITY:**

In Stock, No Wait.

#### **MARCH CHROME**

**OVERVIEW:**

This March classic features triple plated chrome and is a highly requested finish type. It has a very reflective deep chrome finish for a stunning but classic look.

**AVAILABILITY:**

In Stock, No Wait.

#### **MARCH BLACK ONYX**

**OVERVIEW:**

A new take on our black finish. Black powder-coat finish, with machine etched edges, covered in a clear powder-coat, creating a glossy black finish with aluminum edges. Finish applied to brackets only, comes paired with clear pulleys.

**AVAILABILITY:**

In Stock, No Wait.

# NEW PRODUCTS & SERVICES

## ALL-NEW WEB EXPERIENCE

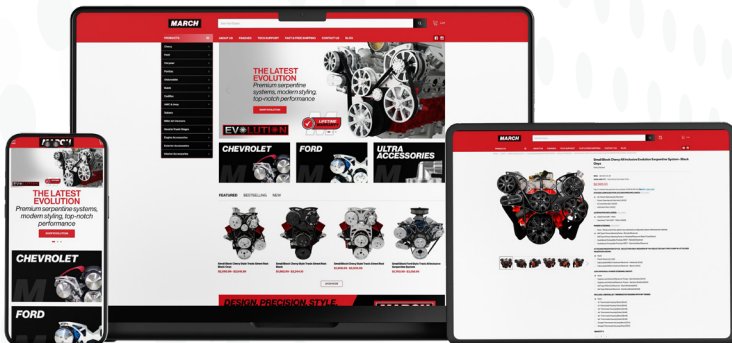

ALL NEW FOR 2025

- M** Fast lead times.
- M** Complete listing of all product lines.
- M** All finish types in stock.
- M** 100% Online direct ordering.
- M** Live chat for sales & tech support.
- M** Streamlined navigation.
- M** Safe & secure checkout.

## FAST & FREE SHIPPING



ALL NEW FOR 2025

- M** Free Shipping in the US on Orders Over \$199.  
*(\$9.99 Flat Shipping on Orders Under \$199)*
- M** Most orders ship within 24 hours.
- M** Orders include real-time tracking.
- M** Fast international shipping.

## LIFETIME WARRANTY

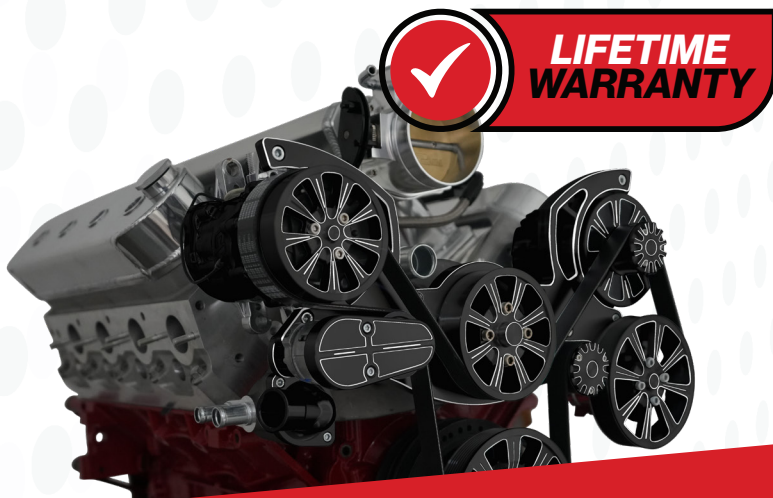

ALL NEW FOR 2025

- M** Buy with confidence knowing that all March products are backed by a Life Time Warranty.
- M** March products are designed & made in the USA. They're 100% thicker than similar products, and far superior than cast brackets.

# MA

# NEW PRODUCTS & SERVICES

## ULTRA ACCESSORIES

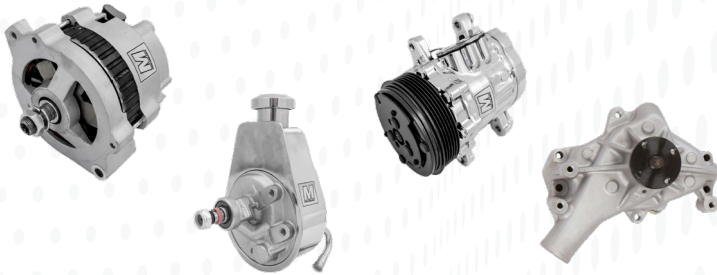

ALL NEW FOR 2025

- M** We offer a complete line of engine accessories that are optimized for performance & compatibility with your serpentine kit.
- M** Accessories are available in multiple finish types and are backed by an industry leading life time warranty.

## NEW SERPENTINE SYSTEM



ALL NEW FOR 2025

- M** New premium serpentine system.
- M** Spring loaded tensioner.
- M** Single bracket design.
- M** Modern pulley spoke design.
- M** Stainless steel hardware.
- M** Billet aluminum spacers.
- M** All inclusive and easy to install.

*Evolution Kits are compatible with: Chevy LS, Chevy Small Block, Chevy Big Block, Chevy LT1, Ford Small Block & Ford 351C.*

## BILLET HOOD/TRUNK HINGES



ALL NEW FOR 2025

- M** Premium March hood & trunk hinges with an innovative design and ease of installation in mind.
- M** Designed to work with all styles of hoods (steel, fiberglass & carbon fiber) and available in multiple finish types

# MARCH

# CHEVY ENGINES

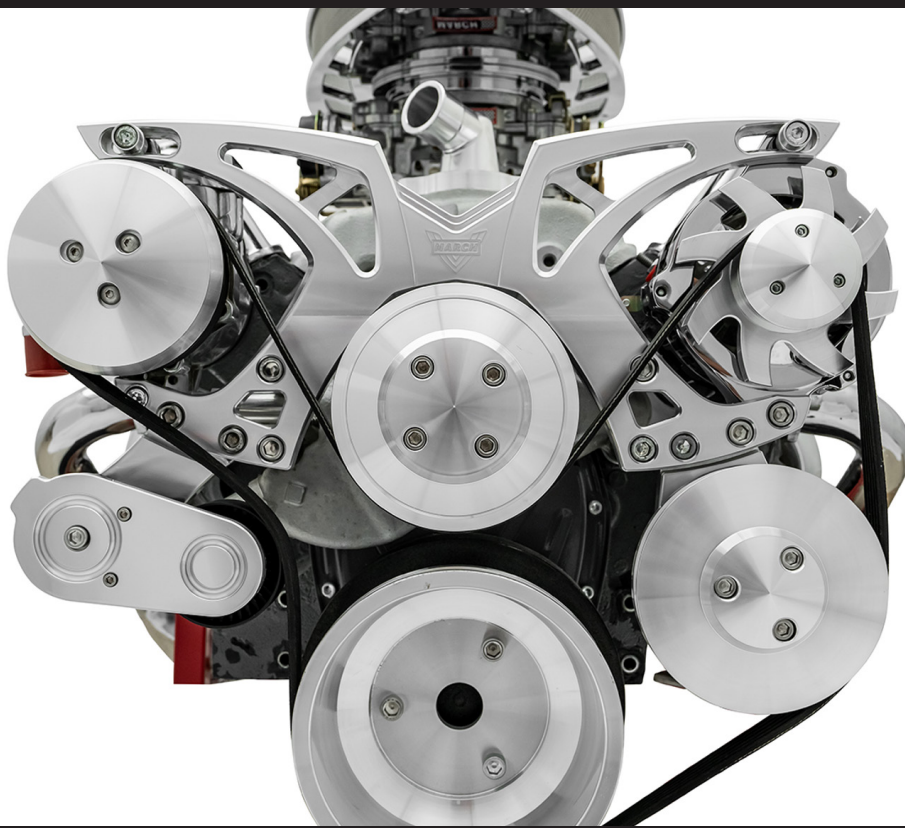

SCAN THE CODE BELOW FOR CHEVY KIT DETAILS, PRICING & AVAILABILITY



## ALL INCLUSIVE KITS AND FINISH TYPES FOR CHEVY ENGINES



## KEY FEATURES, DETAILS & TECHNICAL SPECIFICATIONS

### FEATURES

**KIT TYPES:** March offers serpentine, v-belt, and individual pulley & bracket kits.  
**ULTRA ACCESSORIES:** In addition, all kits have options for our March Ultra series accessories, including alternators, power steering pumps, water pumps & AC compressors.  
**LIFE TIME WARRANTY:** All March pulleys, brackets, engine accessories include an industry leading Life Time Warranty.

### TECHNICAL DETAILS

**DIMENSIONS & COMPATIBILITY:** Visit [marchperformance.com](http://marchperformance.com) for full details.  
**TECH SUPPORT:** All March products include free support for the life time of the product. Call 1.888.729.9070 or email [info@marchperformance.com](mailto:info@marchperformance.com).

PG	ENGINE TYPE
09	SMALL BLOCK
18	BIG BLOCK
24	LS
27	LT1 Gen V
28	LT1 Gen II
29	348-409
29	LATE MODEL & TRUCKS



# CHEVY SMALL BLOCK

## EVOLUTION

**PATENT PENDING**

### M TOP OF THE LINE

All stainless steel hardware and coated billet spacers.

### M SINGLE BRACKET

Extra thick single mounting bracket prevents deflection in even the highest horsepower builds.

### M TENSIONER

Spring loaded belt tensioner with patent pending mounting adjustability.

### M PS PUMP OPTIONS

Choose from 4 different power steering options:  
 GM Type II w/Remote Reservoir  
 GM Type II w/Attached Reservoir  
 Hydroboost w/Remote Reservoir  
 Hydroboost w/Attached Reservoir

### M SPOKE PULLEYS

Premium spoke design on our pulleys for a sleek and modern style.

### M ADJUST TIMING

Removable cap to adjust timing without the need to remove the entire crankshaft pulley.

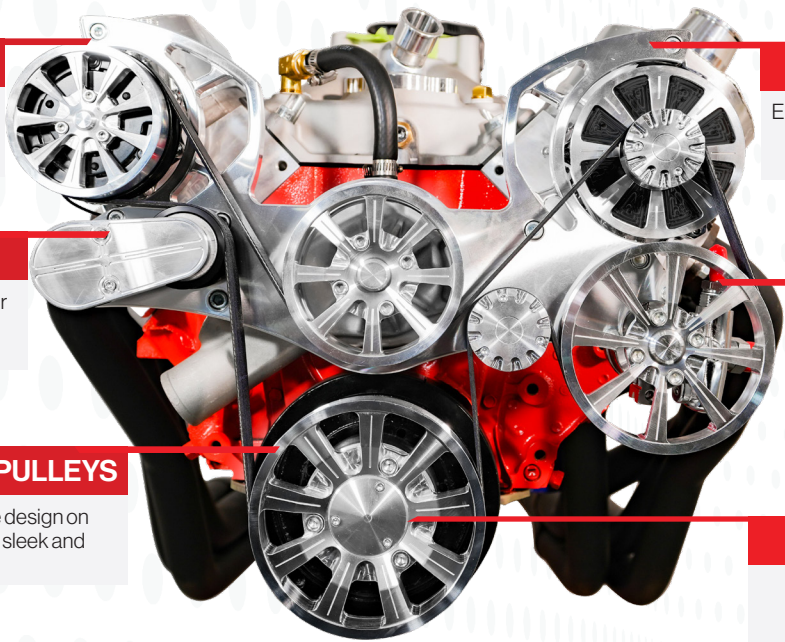

### BLACK ONYX

### BLACK

### CLEAR

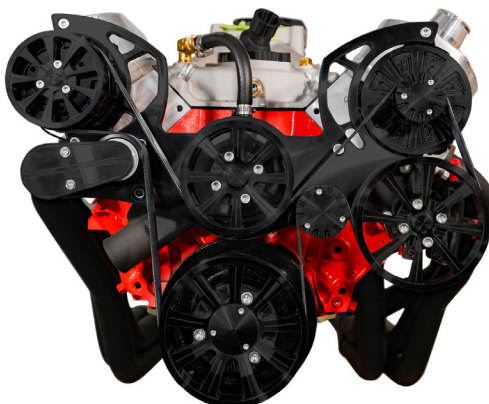
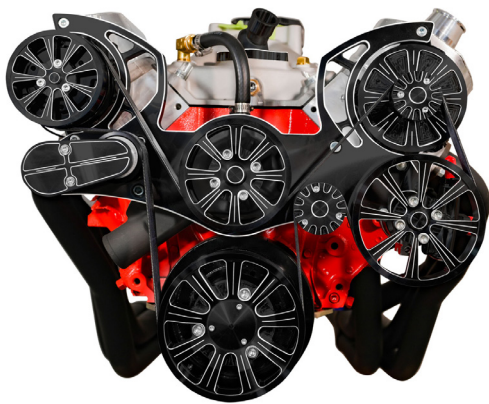

**M KIT PRICE: \$2995.00**

BLACK ONYX

**350-EV-AC-87**

AC, Power Steering & Alternator

**M KIT PRICE: \$2795.00**

BLACK

**350-EV-AC-88**

AC, Power Steering & Alternator

**M KIT PRICE: \$2795.00**

CLEAR

**350-EV-AC**

AC, Power Steering & Alternator

**AVAILABLE IN 4 CONFIGURATIONS:** 1 AC + Power Steering + Alt. 2 AC + Alt. 3 Power Steering + Alt. 4 Alternator Only

### TECHNICAL SPECIFICATIONS

Includes hub adapter to work with OEM Balancers. *\*Evolution Exclusive\**  
 4 Power Steering Options include pump and reservoir. *\*Evolution Exclusive\**  
 Compatible with Hydroboost. *\*Evolution Exclusive\**  
 Includes 140 AMP Alternator - upgradeable to 300AMP.  
 Utilizes 8-Rib Serpentine belt (included).



**SCAN THE CODE TO VIEW CHEVY SB EVOLUTION KITS**

## Style TRACK

### MID-MOUNT



SKU  
21100-07

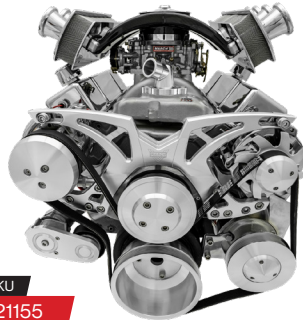

SKU  
21155

#### KIT DETAILS

- » Price includes water pump, alternator, power steering pump, AC compressor, brackets, pulleys, and hardware. Remote reservoir and belt not included.
- » For Corvette applications, visit [marchperformance.com/chevy/corvette](http://marchperformance.com/chevy/corvette)

EWP  
EWP

APPLICATION	KIT CODE	PRICE
AC, PS & ALT GM Type II Pump w/ Remote Reservoir	21150	<b>M</b> \$1975. <sup>95</sup>
AC, PS & ALT Saginaw Pump (Keyway)	21155	<b>M</b> \$1975. <sup>95</sup>
AC & ALT	21100	<b>M</b> \$1875. <sup>95</sup>
PS & ALT Billet Accessories	21185	<b>M</b> \$2194. <sup>95</sup>
PS & ALT Chrome Accessories	21190	<b>M</b> \$1895. <sup>95</sup>
AC, PS & ALT GM Type II Power Steering	22115	<b>M</b> \$2299. <sup>95</sup>
AC & ALT	22110	<b>M</b> \$2199. <sup>95</sup>



## Style TRACK

### STREET ROD STYLE TRACK INWARD MOUNT



SKU  
22210-08



SKU  
22250

#### KIT DETAILS

- » Price includes water pump, alternator, power steering pump, AC compressor, brackets, pulleys and hardware. Belt and remote reservoir not included.



APPLICATION	KIT CODE	PRICE
AC, PS & ALT GM Type II Pump w/ Remote Reservoir	22250	<b>M</b> \$2199. <sup>95</sup>
AC, PS & ALT Saginaw Pump (Keyway)	22255	<b>M</b> \$2199. <sup>95</sup>
AC & ALT	22210	<b>M</b> \$2099. <sup>95</sup>

**Ideal for tight applications.** March Street Rod Style Track serpentine systems are the most compact on the market at only 5.5" from the block!

## ULTRA DRIVE SERPENTINE KITS

### ULTRA DRIVE MID-MOUNT



SKU  
20220-08



SKU  
20260

#### KIT DETAILS

- » Price includes water pump, alternator, power steering pump, AC compressor, pulleys, brackets and hardware. Belt and remote reservoir not included.



APPLICATION	KIT CODE	PRICE
AC, PS & ALT GM Type II Pump w/ Remote Reservoir	20260	<b>M</b> \$1999. <sup>95</sup>
AC & ALT	20250	<b>M</b> \$1899. <sup>95</sup>
AC, PS & ALT Revolver Style, Type II Pump w/ Remote Reservoir	20225	<b>M</b> \$1999. <sup>95</sup>
AC & ALT Revolver Style	20220	<b>M</b> \$1899. <sup>95</sup>

APPLICATION	KIT CODE	
AC, PS & ALT GM Type II Pump w/ Remote Reservoir	21615	<b>M</b> \$1995.95
AC, PS & ALT Saginaw Pump (Keyway)	21620	<b>M</b> \$1995.95
AC & ALT	21610	<b>M</b> \$1895.95

ALL INCLUSIVE SPORT TRACK SERIES **SPORT TRACK**



SKU  
21610-08

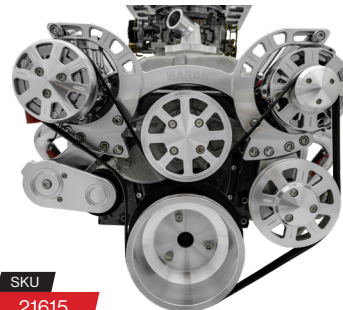

SKU  
21615



**QUESTIONS?**  
CONTACT OUR WORLD CLASS SUPPORT TEAM  
**(888) 729-9070**



**KIT DETAILS**

» Price includes new water pump, alternator, power steering pump, AC compressor, brackets, pulleys and hardware. Belt and remote reservoir not included.

APPLICATION	KIT CODE	
AC, PS & ALT GM Type II Pump w/ Remote Reservoir	21160	<b>M</b> \$1995.95
AC, PS & ALT Saginaw Pump (Keyway)	21165	<b>M</b> \$1995.95
AC & ALT Chrome Accessories	21110	<b>M</b> \$1895.95
PS & ALT Billet Accessories, GM Type II Pump	21085	<b>M</b> \$2398.95
PS & ALT Chrome Accessories, GM Type II Pump	21090	<b>M</b> \$1895.95

ALL INCLUSIVE REVOLVER SERIES **Revolver**



SKU  
21085-07



SKU  
21160



**KIT DETAILS**

» Price includes new water pump, alternator, power steering pump, AC compressor, brackets, pulleys and hardware. Belt and remote reservoir not included.

APPLICATION	KIT CODE	
AC, PS & ALT Style Track - GM Type II Remote PS	21850	<b>M</b> \$1599.95
AC, PS & ALT Style Track - Saginaw Pump	21855	<b>M</b> \$1599.95
AC & ALT Style Track	21800	<b>M</b> \$1499.95
PS & ALT Style Track - Saginaw Pump	CS21190	<b>M</b> \$1499.95
PS & ALT Revolver - Saginaw Keyway	CS21090	<b>M</b> \$1499.95
AC, PS & ALT Sport Track - Saginaw Keyway	21660-09	<b>M</b> \$1599.95
AC, PS & ALT Sport Track - GM Type II Pump	21655-09	<b>M</b> \$1599.95
AC & ALT Sport Track	21650-09	<b>M</b> \$1499.95

ALL INCLUSIVE CUSTOM SERIES **CUSTOM SERIES**



SKU  
21800-08



SKU  
21850



SKU  
21655-09



SKU  
CS21090-08



**KIT DETAILS**

» Removes decorative caps and utilizes as cast accessories.  
» Price includes new water pump, alternator, power steering pump, AC compressor, brackets, pulleys and hardware. Belt and remote reservoir not included.

### ULTRA

#### STANDARD MOUNT ULTRA SERIES » LONG WATER PUMP

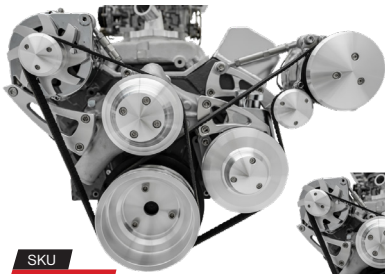

SKU  
22070



SKU  
22050

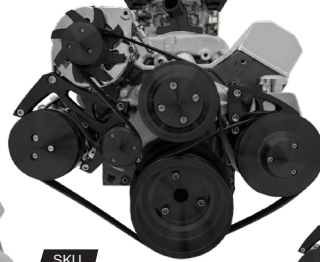

SKU  
22072-08



SKU  
22045-08

#### KIT DETAILS

- » Price includes brackets, pulleys & hardware.
- » Requires the use of 7" Small Block Chevy long water pump (March #P2216).

#### APPLICATION

#### KIT CODE

<b>AC, PS &amp; ALT</b> Saginaw Keyway, 7176 AC, High Flow	22072	<b>M</b> \$825.95
<b>AC, PS &amp; ALT</b> Saginaw Press, 7176 AC, High Flow	22082	<b>M</b> \$825.95
<b>AC, PS &amp; ALT</b> Saginaw Keyway, 508 AC, High Flow	22070	<b>M</b> \$825.95
<b>AC, PS &amp; ALT</b> Saginaw Press, 508 AC, High Flow	22080	<b>M</b> \$825.95
<b>PS &amp; ALT</b> Saginaw Keyway, High Flow	22050	<b>M</b> \$599.95
<b>PS &amp; ALT</b> Saginaw press fit, High Flow	22060	<b>M</b> \$599.95
<b>AC &amp; ALT</b> 7176 AC, High Flow	22045	<b>M</b> \$723.95
<b>Alternator Only</b> High Flow	22040	<b>M</b> \$459.95



### CUSTOM SERIES

#### MID-MOUNT CUSTOM SERIES » LONG WATER PUMP



SKU  
22024-08



SKU  
22037-08

#### KIT DETAILS

- » Price includes brackets, pulleys & hardware. See part 21690 for an all inclusive version.
- » Requires 7" Small Block Chevy long water pump, standard rotation. (March #P2216).

#### APPLICATION

#### KIT CODE

<b>AC, PS &amp; ALT</b> Saginaw Keyway, 7176 AC, High Flow	22037-08	<b>M</b> \$509.95
<b>PS &amp; ALT</b> Saginaw Keyway, High Flow	22024-08	<b>M</b> \$441.95
<b>ALTERNATOR ONLY</b> High Flow	22022-08	<b>M</b> \$319.95



### Style TRACK

#### STYLE TRACK SERIES » LONG WATER PUMP



SKU  
25153-08

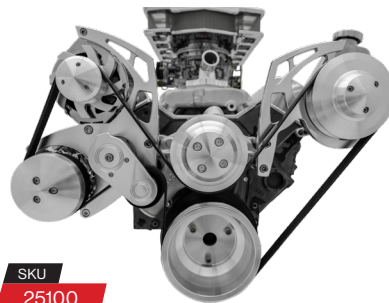

SKU  
25100

#### KIT DETAILS

- » Price includes brackets, pulleys & hardware.
- » Requires the use of 7" Small Block Chevy long water pump, reverse rotation.

#### APPLICATION

#### KIT CODE

<b>AC, PS &amp; ALT</b> Saginaw Keyway, 7176 AC, High Flow	25100	<b>M</b> \$884.95
<b>AC, PS &amp; ALT</b> Saginaw Press, 7176 AC, High Flow	25110	<b>M</b> \$884.95
<b>PS &amp; ALT</b> Saginaw Keyway, High Flow	25150	<b>M</b> \$633.95
<b>AC, PS &amp; ALT</b> Custom Series, Saginaw Key, 7176 AC	25103-08	<b>M</b> \$645.95
<b>PS &amp; ALT</b> Custom Series, Saginaw Key	25153-08	<b>M</b> \$545.95



APPLICATION	KIT CODE	
AC, PS & ALT <small>Saginaw Keyway, 508AC, High Flow</small>	22071	<b>M</b> \$766. <sup>95</sup>
AC, PS & ALT <small>Saginaw Press, 508AC, High Flow</small>	22081	<b>M</b> \$766. <sup>95</sup>
PS & ALT <small>Saginaw Keyway, High Flow</small>	22051	<b>M</b> \$492. <sup>95</sup>
PS & ALT <small>Saginaw Press, High Flow</small>	22061	<b>M</b> \$492. <sup>95</sup>
PS & ALT <small>Saginaw Keyway, Underdrive</small>	22021	<b>M</b> \$492. <sup>95</sup>
ALTERNATOR ONLY <small>Value Line (no covers), High Flow</small>	22041	<b>M</b> \$354. <sup>95</sup>
ALTERNATOR ONLY <small>Underdrive</small>	22011	<b>M</b> \$499. <sup>95</sup>

MID-MOUNT DELUXE SERIES » LONG WATER PUMP

**DELUXE**

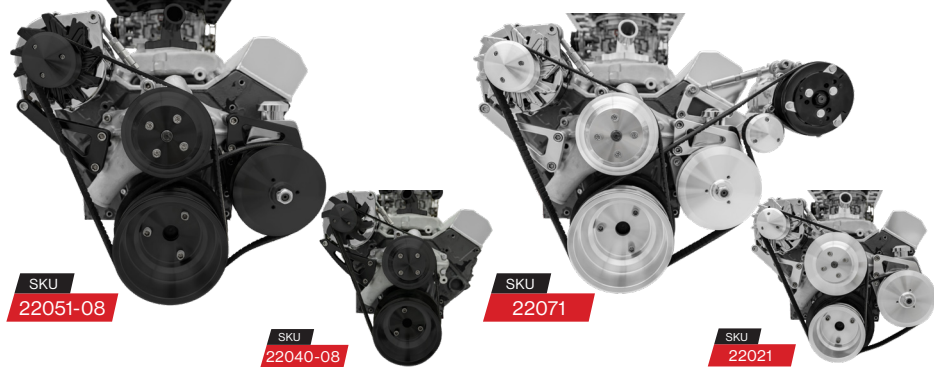

SKU 22051-08

SKU 22040-08

SKU 22071

SKU 22021



KIT DETAILS

- » Price includes brackets, pulleys & hardware.
- » Requires the use of 7" Small Block Chevy long water pump, standard rotation (P2216).

APPLICATION	KIT CODE	
PS & ALT <small>Saginaw Keyway, High Flow</small>	22095	<b>M</b> \$390. <sup>95</sup>
ALTERNATOR ONLY <small>High Flow</small>	22090	<b>M</b> \$230. <sup>95</sup>

SUPER ECONOMY SERIES

**DELUXE**

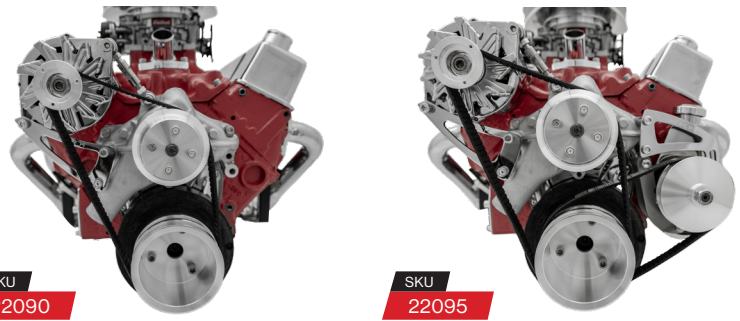

SKU 22090

SKU 22095



KIT DETAILS

- » Steel brackets (chrome); Rear supports (silver) & billet pulleys.
- » Requires 7" Small Block Chevy long water pump.
- » Price includes brackets, pulleys, and hardware.

APPLICATION	KIT CODE	
PS & ALT <small>Saginaw Keyway</small>	22016	<b>M</b> \$628. <sup>95</sup>
PS & ALT <small>Saginaw Press</small>	22017	<b>M</b> \$628. <sup>95</sup>
ALTERNATOR ONLY	22015	<b>M</b> \$399. <sup>95</sup>

MID-MOUNT ULTRA SERIES » ELECTRIC WATER PUMP

**ULTRA**

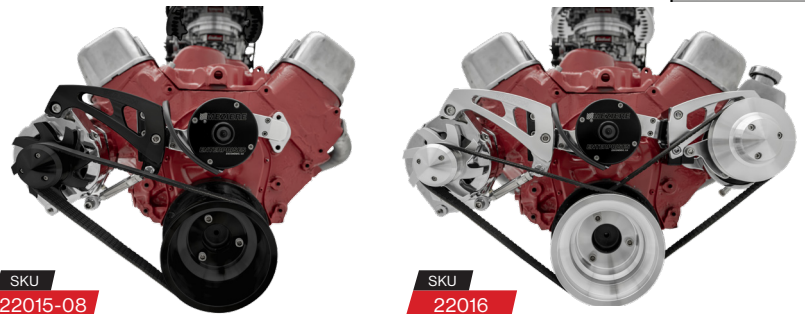

SKU 22015-08

SKU 22016



KIT DETAILS

- » Price includes brackets, pulleys, and hardware.
- » Compatible with Meziere, CSI, CSR, or Proform EWP's (March #P821).

### DELUXE OUTWARD MOUNT DELUXE SERIES

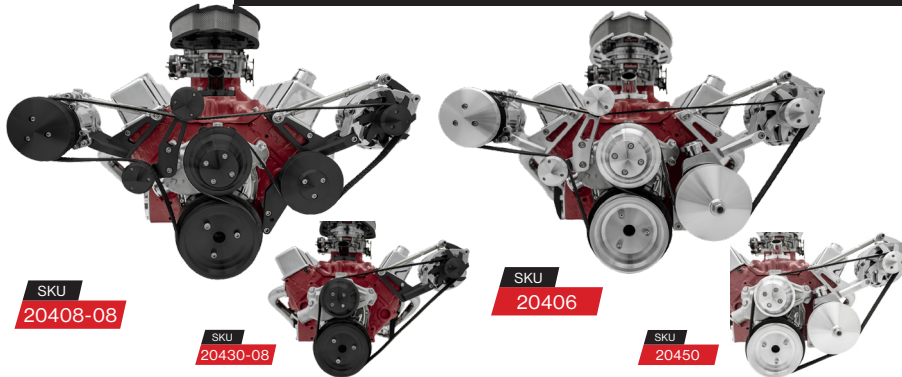

SKU  
20408-08

SKU  
20430-08

SKU  
20406

SKU  
20450

#### KIT DETAILS

- » Price includes brackets, pulleys & hardware.
- » AC applications require Small Block Chevy reverse rotation water pump (5.8125").
- » Non-AC applications require Small Block Chevy standard rotation short water pump (5.625").

#### APPLICATION

#### KIT CODE

<b>AC, PS &amp; ALT</b> Saginaw Keyway, 508 AC, Standard Heads	20406	<b>M</b> \$1149.95
<b>AC, PS &amp; ALT</b> Saginaw Keyway, 508 AC, L98/VZ4 Heads	20416	<b>M</b> \$1149.95
<b>AC, PS &amp; ALT</b> GM Type II Remote PS, 508 AC, Standard Heads	20408	<b>M</b> \$1199.95
<b>AC, PS &amp; ALT</b> GM Type II Remote PS, 508 AC, L98/VZ4 Heads	20418	<b>M</b> \$1249.95
<b>PS &amp; ALT</b> Saginaw Keyway, High Flow	20450	<b>M</b> \$635.95
<b>PS &amp; ALT</b> Saginaw Keyway, Underdrive	20440	<b>M</b> \$635.95
<b>AC &amp; ALT</b> GM Type II Remote PS, High Flow	20470	<b>M</b> \$685.95
<b>ALTERNATOR ONLY</b> High Flow	20430	<b>M</b> \$525.95



### ULTRA OUTWARD MOUNT ULTRA SERIES



SKU  
20471-08

SKU  
20426

#### KIT DETAILS

- » Price includes brackets, pulleys & hardware. Belts and remote reservoir not included.
- » AC applications require Small Block Chevy reverse rotation water pump (5.8125")
- » Non-AC applications require Small Block Chevy short water pump (5.625")

#### APPLICATION

#### KIT CODE

<b>AC, PS &amp; ALT</b> Saginaw Keyway, 508 AC, High Flow	20426	<b>M</b> \$1299.95
<b>AC, PS &amp; ALT</b> GM Type II Remote PS, 508 AC, High Flow	20428	<b>M</b> \$1349.95
<b>AC, PS &amp; ALT</b> Saginaw Press, 508 AC, High Flow	20427	<b>M</b> \$1299.95
<b>AC &amp; ALT</b> 508 AC, High Flow	20425	<b>M</b> \$1149.95
<b>PS &amp; ALT</b> Saginaw Keyway, High Flow	20451	<b>M</b> \$804.95
<b>PS &amp; ALT</b> Saginaw press fit, High Flow	20456	<b>M</b> \$804.95
<b>PS &amp; ALT</b> GM Type II Remote PS, High Flow	20471	<b>M</b> \$854.95
<b>ALTERNATOR ONLY</b> High Flow	20432	<b>M</b> \$632.95



# M

PERFORMANCE

## ULTRA ACCESSORIES



To view all of our accessories visit the Accessories section in the back of the catalog.

APPLICATION	KIT CODE		
<b>AC, PS &amp; ALT</b> Saginaw Keyway, 508 AC, Driver Side ALT	20734	<b>M</b>	\$923. <sup>95</sup>
<b>AC, PS &amp; ALT</b> GM Type II Remote PS, 508 AC, Driver Side ALT	20736	<b>M</b>	\$923. <sup>95</sup>
<b>AC &amp; ALT</b> 508 AC, Driver Side ALT	20733	<b>M</b>	\$786. <sup>95</sup>
<b>PS &amp; ALT</b> Saginaw Keyway, Passenger Side ALT	20745	<b>M</b>	\$697. <sup>95</sup>
<b>PS &amp; ALT</b> GM Type II Remote PS, Passenger Side ALT	20747	<b>M</b>	\$697. <sup>95</sup>
<b>PS &amp; ALT</b> Saginaw Keyway, High Flow	20730	<b>M</b>	\$704. <sup>95</sup>
<b>PS &amp; ALT</b> Saginaw Keyway, Underdrive	20726	<b>M</b>	\$704. <sup>95</sup>
<b>ALTERNATOR ONLY</b> High Flow, Passenger Side ALT	20744	<b>M</b>	\$542. <sup>95</sup>
<b>ALTERNATOR ONLY</b> High Flow, Driver's Side ALT	20729	<b>M</b>	\$542. <sup>95</sup>

INWARD MOUNT ULTRA SERIES

**ULTRA**

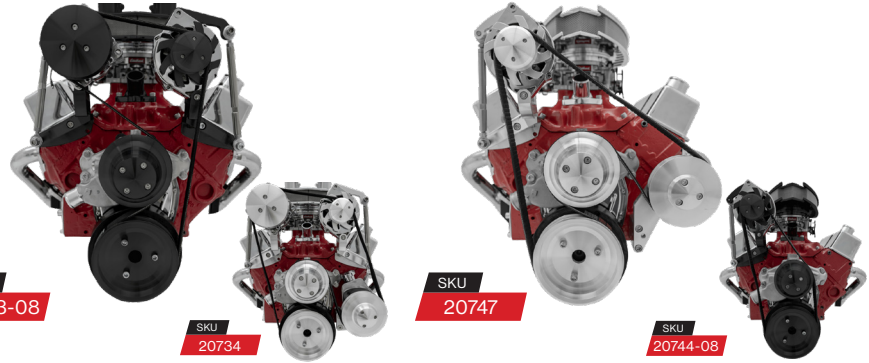

SKU  
20733-08

SKU  
20734

SKU  
20747

SKU  
20744-08

**KIT DETAILS**

- » Price includes brackets, pulleys & hardware. Belt and remote reservoir not included.
- » AC applications require Small Block Chevy reverse rotation water pump (5.8125").
- » Non-AC applications require Small Block Chevy short water pump (5.625").
- » Requires cylinder heads w/ 3 bolt pattern (will not work with single bolt pattern).



APPLICATION	KIT CODE		
<b>AC, PS &amp; ALT</b> Saginaw Keyway, 508 AC	21015	<b>M</b>	\$652. <sup>95</sup>
<b>AC, PS &amp; ALT</b> GM Type II Remote PS, 508 AC	21017	<b>M</b>	\$702. <sup>95</sup>
<b>AC, PS &amp; ALT</b> Saginaw Press, 508 AC	21016	<b>M</b>	\$652. <sup>95</sup>
<b>PS &amp; ALT</b> Saginaw Keyway	21011	<b>M</b>	\$511. <sup>95</sup>
<b>PS &amp; ALT</b> Saginaw Press	21012	<b>M</b>	\$511. <sup>95</sup>
<b>ALTERNATOR ONLY</b>	21010	<b>M</b>	\$393. <sup>95</sup>

INWARD MOUNT DELUXE SERIES

**DELUXE**

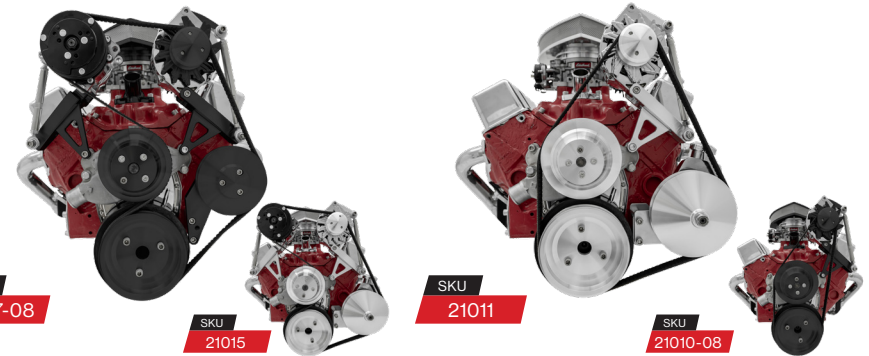

SKU  
21017-08

SKU  
21015

SKU  
21011

SKU  
21010-08

**KIT DETAILS**

- » Price includes brackets, pulleys & hardware. Belt and remote reservoir not included.
- » AC applications require Small Block Chevy reverse rotation water pump (5.8125").
- » Non-AC applications require Small Block Chevy standard rotation short water pump (5.625").
- » Will work w/ 1 or 3 bolt head pattern..



APPLICATION	KIT CODE		
<b>AC, PS &amp; ALT</b> Saginaw Keyway, 508 AC,	20711	<b>M</b>	\$699. <sup>95</sup>
<b>AC, PS &amp; ALT</b> Saginaw Keyway, 508 AC, Value (No Covers)	20706	<b>M</b>	\$590. <sup>95</sup>
<b>AC, PS &amp; ALT</b> GM Type II Remote PS, 508 AC	20713	<b>M</b>	\$768. <sup>95</sup>
<b>AC, PS &amp; ALT</b> GM Type II Remote PS, 508 AC, Value (No Covers)	20708	<b>M</b>	\$590. <sup>95</sup>

INWARD MOUNT DELUXE SERIES (ONE PIECE)

**DELUXE**

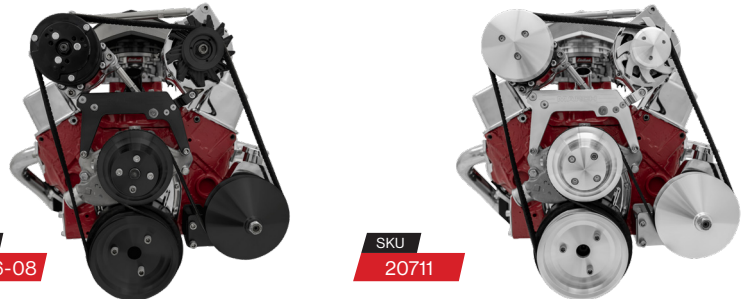

SKU  
20706-08

SKU  
20711

**KIT DETAILS**

- » Price includes brackets, pulleys, and hardware.
- » Requires the use of 5.625" Small Block Chevy short water pump.





### SERPENTINE PULLEY KITS

PULLEY KIT	WATER PUMP TYPE	PULLEY RATIO	WATER PUMP PULLEY (1V)	CRANKSHAFT PULLEY	ALT. PULLEY (1V)	PS PULLEY KEYWAY/PRESS
6270 <b>\$258</b>	SHORT	HIGHFLOW	6222 (5.25") <b>\$116</b>	1V 6271 (7") <b>\$98</b>	208 (2.75") <b>\$61</b>	
6210 <b>\$243</b>	SHORT	PERFORMANCE	6212 (6.25") <b>\$117</b>	1V 6211 (5.75") <b>\$83</b>	208 (2.75") <b>\$61</b>	
6321-112 <b>\$244</b>	LONG	HIGHFLOW	6323 (4.5") <b>\$111</b>	2V 6321 (5.5") <b>\$109</b>	112 (1.69") <b>\$64</b>	611
6380 <b>\$249</b>	LONG	HIGHFLOW	6322 (5.25") <b>\$117</b>	2V 6381 (7") <b>\$139</b>	208 (2.75") <b>\$61</b>	623 / 624
6370 <b>\$260</b>	LONG	HIGHFLOW	6322 (5.25") <b>\$117</b>	1V 6371 (7") <b>\$107</b>	208 (2.75") <b>\$61</b>	
6355 <b>\$257</b>	LONG	MID-PERFORMANCE	6322 (5.25") <b>\$117</b>	2V 6331 (5.75") <b>\$91</b>	208 (2.75") <b>\$61</b>	623 / 624
6350 <b>\$257</b>	LONG	MID-PERFORMANCE	6322 (5.25") <b>\$117</b>	1V 6311 (5.75") <b>\$101</b>	208 (2.75") <b>\$61</b>	
6330 <b>\$263</b>	LONG	PERFORMANCE	6312 (6.25") <b>\$114</b>	2V 6331 (5.75") <b>\$91</b>	208 (2.75") <b>\$61</b>	623 / 624
6310 <b>\$257</b>	LONG	PERFORMANCE	6312 (6.25") <b>\$114</b>	1V 6311 (5.75") <b>\$101</b>	208 (2.75") <b>\$61</b>	

» March Performance recommends high flow for most applications.

» Pulley kits include water pump, crank and alternator pulley. Power steering pulleys are sold separately.

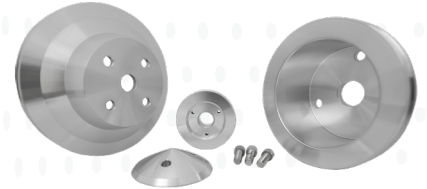

### V-BELT PULLEY KITS

PULLEY KIT	WATER PUMP TYPE	PULLEY RATIO	WATER PUMP PULLEY	CRANKSHAFT PULLEY	ALT. PULLEY (1V)	PS PULLEY KEYWAY/PRESS
6110 <b>\$228</b>	SHORT	HIGHFLOW	1V 6012 (6.25") <b>\$106</b>	1V 6111 (7") <b>\$78</b>	137 (2.69") <b>\$56</b>	
6120 <b>\$253</b>	SHORT	HIGHFLOW	2V 6032 (6.25") <b>\$114</b>	2V 6131 (7") <b>\$114</b>	137 (2.69") <b>\$56</b>	523 / 515
6130 <b>\$269</b>	SHORT	HIGHFLOW	1V 6012 (6.25") <b>\$106</b>	2V 6131 (7") <b>\$114</b>	137 (2.69") <b>\$56</b>	523 / 515
6140 <b>\$274</b>	SHORT	HIGHFLOW	2V 6032 (6.25") <b>\$114</b>	3V 6151 (7") <b>\$116</b>	137 (2.69") <b>\$56</b>	510 / 511
6010 <b>\$228</b>	SHORT	PERFORMANCE	1V 6012 (6.25") <b>\$106</b>	1V 6011 (5.5") <b>\$68</b>	137 (2.69") <b>\$56</b>	
6015 <b>\$251</b>	SHORT	PERFORMANCE	1V 6012 (6.25") <b>\$106</b>	2V 6031 (5.5") <b>\$89</b>	137 (2.69") <b>\$56</b>	523 / 515
6030 <b>\$255</b>	SHORT	PERFORMANCE	2V 6032 (6.25") <b>\$114</b>	2V 6031 (5.5") <b>\$89</b>	137 (2.69") <b>\$56</b>	523 / 515
5090 <b>\$273</b>	SHORT	PERFORMANCE	2V 6032 (6.25") <b>\$114</b>	3V 5091 (5.5") <b>\$120</b>	137 (2.69") <b>\$56</b>	510 / 511
6160 <b>\$290</b>	LONG	HIGHFLOW	1V 6152 (5.5") <b>\$113</b>	1V 6161 (7") <b>\$109</b>	137 (2.69") <b>\$56</b>	
6170 <b>\$276</b>	LONG	HIGHFLOW	1V 6152 (5.5") <b>\$113</b>	2V 6171 (7") <b>\$112</b>	137 (2.69") <b>\$56</b>	513 / 531
6190 <b>\$275</b>	LONG	HIGHFLOW	2V 6092 (6.25") <b>\$106</b>	3V 6191 (7") <b>\$131</b>	137 (2.69") <b>\$56</b>	521 / 520
6050 <b>\$245</b>	LONG	PERFORMANCE	1V 6052 (6.25") <b>\$119</b>	1V 6051 (5.5") <b>\$91</b>	137 (2.69") <b>\$56</b>	
6070 <b>\$244</b>	LONG	PERFORMANCE	1V 6052 (6.25") <b>\$119</b>	2V 6071 (5.5") <b>\$101</b>	137 (2.69") <b>\$56</b>	513 / 531
6090 <b>\$263</b>	LONG	PERFORMANCE	2V 6092 (6.25") <b>\$106</b>	3V 6091 (5.5") <b>\$113</b>	137 (2.69") <b>\$56</b>	521 / 520
6095 <b>\$282</b>	LONG	PERFORMANCE	3V 6112 (6.25") <b>\$113</b>	3V 6091 (5.5") <b>\$113</b>	137 (2.69") <b>\$56</b>	521 / 520

» March Performance recommends high flow for most applications.

» Power steering pulleys are not included in kit price.

» See website for Corvette applications.



ALT. BRACKETS	KIT CODE	
<b>ULTRA SERIES</b> High mount, passenger side, LWP	20120	<b>M</b> \$94. <sup>95</sup>
<b>DELUXE SERIES</b> High mount, passenger side, LWP	20121	<b>M</b> \$80. <sup>95</sup>
<b>SUPER ECONOMY</b> High mount, passenger side, steel, chrome, LWP	P80120-06	<b>M</b> \$49. <sup>95</sup>
<b>ULTRA SERIES</b> Mid-mount, passenger side, LWP	20124	<b>M</b> \$123. <sup>95</sup>
<b>DELUXE SERIES</b> High inward mount, driver's side, SWP	21001	<b>M</b> \$166. <sup>95</sup>
<b>ULTRA SERIES</b> High inward mount, passenger side, SWP	20720	<b>M</b> \$201. <sup>95</sup>
<b>ULTRA SERIES</b> Low mount, driver's side, SWP	20215	<b>M</b> \$192. <sup>95</sup>
<b>DELUXE SERIES</b> Outward mount, driver's side, SWP	20130	<b>M</b> \$201. <sup>95</sup>
<b>ULTRA SERIES</b> Outward mount, passenger side, SWP	20132	<b>M</b> \$229. <sup>95</sup>
<b>ULTRA SERIES</b> Outward mount, driver's side, SWP	20131	<b>M</b> \$195. <sup>95</sup>
<b>ULTRA SERIES</b> Mid-mount, passenger side, EWP	22025	<b>M</b> \$194. <sup>95</sup>
<b>REAR SUPPORT</b> Use w/ mid-mount for fuelie/damaged heads, LWP	20122-09	<b>M</b> \$41. <sup>95</sup>



## ALTERNATOR BRACKETS



SKU  
20120

SKU  
20121-08

SKU  
P80120-06

SKU  
21001

SKU  
22025-08

SKU  
20130

PS. BRACKETS	KIT CODE	
<b>ULTRA SERIES</b> Mid-mount, Saginaw, LWP	20160	<b>M</b> \$132. <sup>95</sup>
<b>DELUXE SERIES</b> Mid-mount, Saginaw, LWP	20161	<b>M</b> \$110. <sup>95</sup>
<b>ULTRA SERIES</b> Adjustable, GM Type I, LWP or SWP	20118	<b>M</b> \$127. <sup>95</sup>
<b>ULTRA 2 SERIES</b> Mid-mount, Saginaw, LWP	25160	<b>M</b> \$159. <sup>95</sup>
<b>ULTRA SERIES</b> Adjustable, Saginaw, LWP or SWP	20112	<b>M</b> \$118. <sup>90</sup>
<b>SUPER ECONOMY</b> Mid-mount, steel, chrome plated	P80160-06	<b>M</b> \$72. <sup>95</sup>
<b>ULTRA SERIES</b> Mid-mount, Saginaw, EWP	22026	<b>M</b> \$193. <sup>95</sup>



## POWER STEERING BRACKETS

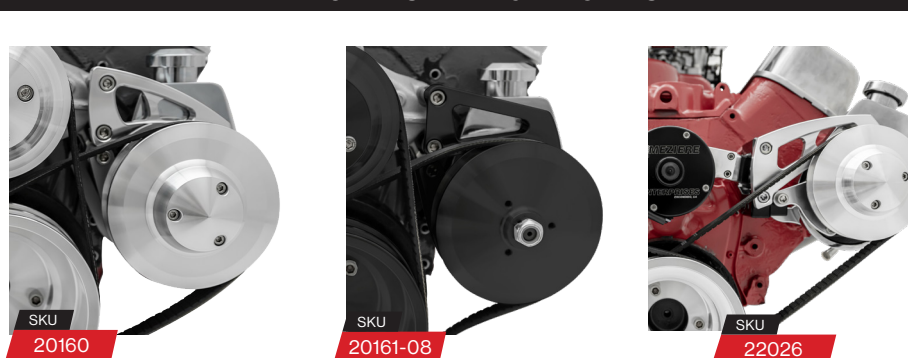

SKU  
20160

SKU  
20161-08

SKU  
22026

A/C BRACKETS	KIT CODE	
<b>DELUXE SERIES</b> Inward mount AC/ALT combo, SWP, 508 AC	20700	<b>M</b> \$177. <sup>95</sup>
<b>ULTRA SERIES</b> Inward mount, passenger, 508 AC, SWP	20722	<b>M</b> \$206. <sup>95</sup>
<b>DELUXE SERIES</b> High inward mount, passenger, 508 AC, SWP	21002	<b>M</b> \$146. <sup>95</sup>
<b>ULTRA SERIES</b> Outward mount, 508 AC, passenger, SWP	20171	<b>M</b> \$231. <sup>95</sup>
<b>DELUXE SERIES</b> Outward mount, 508 AC, passenger, SWP	20155	<b>M</b> \$201. <sup>95</sup>



## AIR CONDITIONING BRACKETS

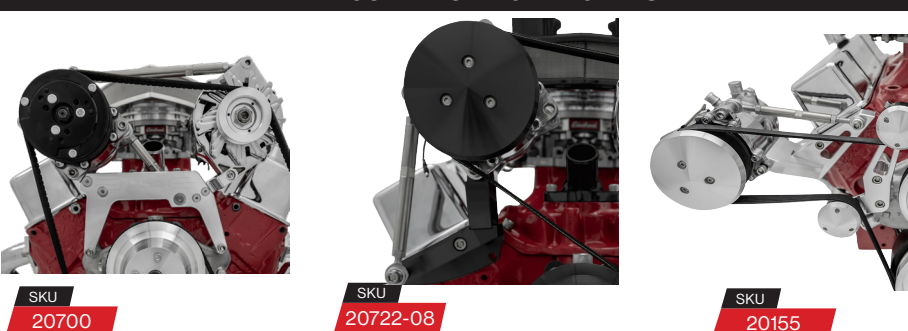

SKU  
20700

SKU  
20722-08

SKU  
20155

# CHEVY BIG BLOCK

ALL INCLUSIVE KITS

## EVOLUTION

### MID-MOUNT EVOLUTION SERIES



SKU  
454-EV-ACO-88



SKU  
454-EV-AC

#### KIT DETAILS

- » Price includes water pump, alternator, power steering pump, AC compressor, brackets, pulleys, belt, PS reservoir and hardware.
- » Requires the use of reverse rotation short water pump (included).

#### APPLICATION

#### KIT CODE

AC, PS & ALT GM Type II Pump w/ Remote Reservoir	454-EV-AC	<b>M</b> \$2795.00
PS & ALT GM Type II Pump w/ Remote Reservoir	454-EV-PS	<b>M</b> \$2695.00
AC & ALT	454-EV-ACO	<b>M</b> \$2695.00
ALTERNATOR ONLY	454-EV-ALT	<b>M</b> \$2595.00

PATENT  
PENDING

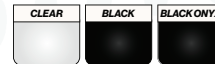

## Style TRACK

### MID-MOUNT STYLE TRACK



SKU  
23210-07



SKU  
21250

#### KIT DETAILS

- » Price includes water pump, alternator, power steering pump, AC compressor, brackets, pulleys and hardware. Belt and remote reservoir not included.
- » Please visit [marchperformance.com/chevy/corvette](http://marchperformance.com/chevy/corvette) for Corvette compatible systems.

EWP  
EWP

#### APPLICATION

#### KIT CODE

AC, PS & ALT GM Type II Remote PS	21250	<b>M</b> \$1995.95
AC, PS & ALT Saginaw Pump (Keyway)	21255	<b>M</b> \$1995.95
AC & ALT	21200	<b>M</b> \$1895.95
PS & ALT Saginaw Pump (Keyway); Billet Accessories	21245	<b>M</b> \$2194.95
PS & ALT Saginaw Pump (Keyway); Chrome Accessories	21240	<b>M</b> \$1895.95
AC, PS & ALT GM Type II Remote PS	23115	<b>M</b> \$2299.95
AC & ALT	23110	<b>M</b> \$2199.95
AC, PS & ALT Street Rod Style (Inward); GM Type II Remote PS	23250	<b>M</b> \$2299.95
AC & ALT Street Rod Style (Inward)	23210	<b>M</b> \$2199.95



## ULTRA DRIVE

### ULTRA DRIVE



SKU  
20320-08



SKU  
20360-06

#### KIT DETAILS

- » Price includes water pump, alternator, power steering pump, AC compressor, pulleys, brackets and hardware. Belt and remote reservoir not included.

#### APPLICATION

#### KIT CODE

AC, PS & ALT GM Type II Remote PS	20360	<b>M</b> \$2399.95
AC & ALT	20350	<b>M</b> \$2299.95
AC, PS & ALT Revolver Style; GM Type II Remote PS	20325	<b>M</b> \$2399.95
AC & ALT Revolver Style	20320	<b>M</b> \$2299.95



APPLICATION	KIT CODE	
AC, PS & ALT GM Type II Pump w/ Remote Reservoir	23615	<b>M</b> \$1995.95
AC, PS & ALT Saginaw Pump (Keyway)	23620	<b>M</b> \$1995.95
AC & ALT	23610	<b>M</b> \$1895.95

MID-MOUNT **SPORT TRACK**

**Optional Add-on Accessories:**

» Remote power steering reservoir. Available in clear, black or chrome.



SKU  
450



SKU  
23610-07

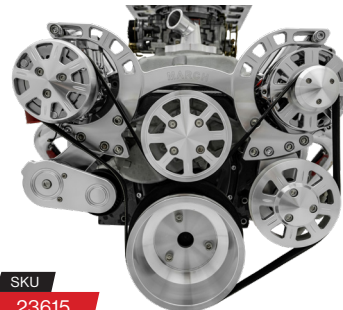

SKU  
23615

**KIT DETAILS**

» Price includes new water pump, alternator, power steering pump, AC compressor, brackets, pulleys and hardware. Belt and remote reservoir not included.



APPLICATION	KIT CODE	
AC, PS & ALT GM Type II Remote Res	21260	<b>M</b> \$1995.95
AC, PS & ALT Saginaw Pump (Keyway)	21265	<b>M</b> \$1995.95
AC & ALT	21210	<b>M</b> \$1895.95
PS & ALT Saginaw Keyway, Billet Accessories	21285	<b>M</b> \$2194.95
PS & ALT Saginaw Keyway, Chrome Accessories	21290	<b>M</b> \$1895.95
PS & ALT Saginaw Keyway, Billet Accessories	23100	<b>M</b> \$2194.95
PS & ALT Saginaw Keyway, Chrome Accessories	23105	<b>M</b> \$1895.95
AC, PS & ALT GM Type II Remote PS, Ultra Drive Style	20325	<b>M</b> \$2399.95

MID-MOUNT **Revolver**



SKU  
21210-07

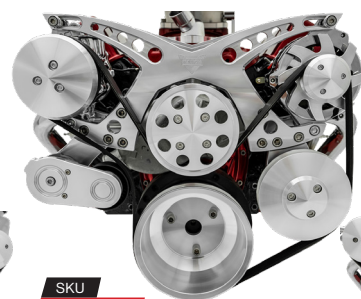

SKU  
21260



SKU  
23105-07



SKU  
20325

**KIT DETAILS**

» Price includes new water pump, alternator, power steering pump, AC compressor, brackets, pulleys and hardware. Belt and remote reservoir not included.  
» Please visit [marchperformance.com/chevy/corvette](http://marchperformance.com/chevy/corvette) for Corvette compatible systems.



APPLICATION	KIT CODE	
AC, PS & ALT Sport Track - GM Type II Remote PS	23655-09	<b>M</b> \$1599.95
AC, PS & ALT Sport Track - Saginaw Pump	23660-09	<b>M</b> \$1599.95
AC & ALT Sport Track	23650-08	<b>M</b> \$1499.95

MID-MOUNT **CUSTOM SERIES**



SKU  
23650-08

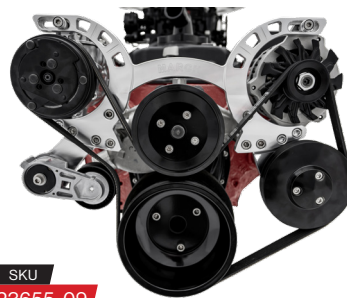

SKU  
23655-09

**KIT DETAILS**

» Removes decorative caps and pulleys for a lower cost  
» Price includes new water pump, alternator, power steering pump, AC compressor, brackets, pulleys and hardware. Belt and remote reservoir not included.



### ULTRA

#### MID-MOUNT ULTRA SERIES » LONG WATER PUMP

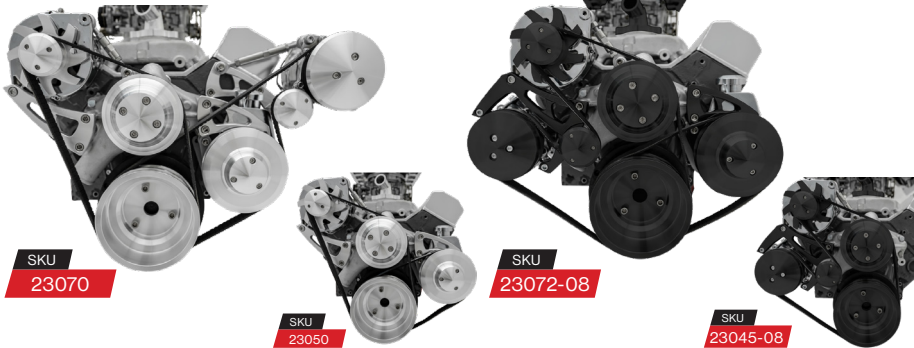

SKU  
23070

SKU  
23050

SKU  
23072-08

SKU  
23045-08

#### KIT DETAILS

- » Price includes brackets, pulleys & hardware.
- » Sanden 508 AC mounts near valve covers on driver's side; Peanut 7176 AC mounts low on the passenger side.
- » Requires Big Block Chevy long water pump (7.287" hub height) (March #P2126).
- » Tall deck motors will require rear support #20128-09

APPLICATION	KIT CODE		
AC, PS & ALT Saginaw Keyway, 7176 AC, High Flow	23072	<b>M</b>	\$896.95
AC, PS & ALT GM Type II Remote PS, 7176 AC	23092	<b>M</b>	\$896.95
AC, PS & ALT Saginaw Keyway, 508 AC, High Flow	23070	<b>M</b>	\$896.95
AC, PS & ALT GM Type II Remote PS, 508 AC, High Flow	23090	<b>M</b>	\$896.95
PS & ALT Saginaw Keyway, High Flow	23050	<b>M</b>	\$615.95
AC & ALT 7176 AC, High Flow	23045	<b>M</b>	\$716.95
ALTERNATOR ONLY	23040	<b>M</b>	\$409.95



### ULTRA

#### EXTRA HIGH ULTRA SERIES

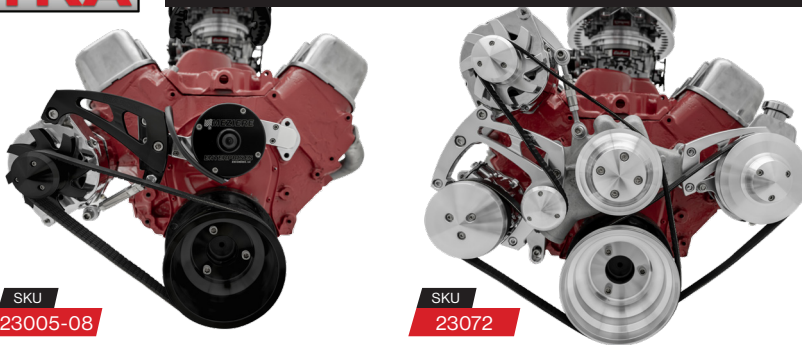

SKU  
23005-08

SKU  
23072

EWP  
EWP  
EWP

#### KIT DETAILS

- » Price includes brackets, pulleys & hardware.
- » This kit raises the power steering pump to clear gear boxes in most GM vehicles.
- » Requires Big Block Chevy long water pump (7.287" hub height).
- » Will not work for tall deck engines without additional modifications (use part number 20123).

APPLICATION	KIT CODE		
AC, PS & ALT Saginaw Keyway, 7176 AC, High Flow	23073	<b>M</b>	\$896.95
AC, PS & ALT Saginaw Press Fit, 7176 AC, High Flow	23083	<b>M</b>	\$896.95
PS & ALT Saginaw Keyway, High Flow	23053	<b>M</b>	\$615.95
ALTERNATOR ONLY High Flow	23043	<b>M</b>	\$409.95
PS & ALT Saginaw Keyway	23006	<b>M</b>	\$634.95
PS & ALT Saginaw Press Fit	23007	<b>M</b>	\$634.95
ALTERNATOR ONLY	23005	<b>M</b>	\$395.95

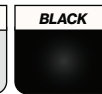

## ULTRA ACCESSORIES



**+MORE!**

To view all of our accessories visit the Accessories section in the back of the catalog.

APPLICATION	KIT CODE	
AC, PS & ALT <small>Saginaw Keyway; 508 AC; Reverse Rotation</small>	20625	<b>M</b> \$869. <sup>95</sup>
AC, PS & ALT <small>GM Type II Remote PS; 508 AC; Reverse Rotation</small>	20635	<b>M</b> \$869. <sup>95</sup>
AC & ALT <small>508 AC; Reverse Rotation</small>	20620	<b>M</b> \$693. <sup>95</sup>
PS & ALT <small>Saginaw Keyway; Standard Rotation</small>	20605	<b>M</b> \$833. <sup>95</sup>
PS & ALT <small>GM Type II Remote PS; Standard Rotation</small>	20615	<b>M</b> \$833. <sup>95</sup>
ALTERNATOR ONLY <small>Standard Rotation</small>	20600	<b>M</b> \$559. <sup>95</sup>

INWARD MOUNT ULTRA SERIES » SHORT WATER PUMP

**ULTRA**

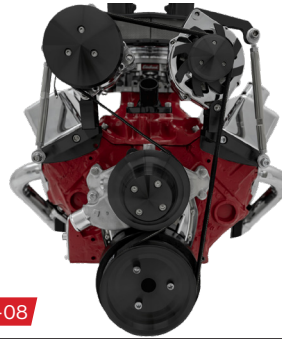

SKU  
20620-08



SKU  
20625

**KIT DETAILS**

- » Price includes brackets, pulleys & hardware.
- » AC applications require reverse rotation water pump (5.75" hub height; March # P2125), non-AC applications require standard rotation water pump (5.75" hub height; March #P2131).
- » Visit [marchperformance.com](http://marchperformance.com) for kits compatible w/ 671 & 871 blower.



APPLICATION	KIT CODE	
AC, PS & ALT <small>Saginaw Keyway; 508 AC</small>	20512	<b>M</b> \$1258. <sup>95</sup>
AC, PS & ALT <small>GM Type II Remote PS; 508 AC</small>	20511	<b>M</b> \$1308. <sup>95</sup>
AC & ALT <small>508 AC</small>	20510	<b>M</b> \$1151. <sup>95</sup>
PS & ALT <small>Saginaw Keyway</small>	20580	<b>M</b> \$784. <sup>95</sup>
PS & ALT <small>GM Type II Remote PS</small>	20560	<b>M</b> \$834. <sup>95</sup>
ALTERNATOR ONLY	20540	<b>M</b> \$695. <sup>95</sup>

OUTWARD MOUNT DELUXE SERIES » SWP

**DELUXE**



SKU  
20540-08

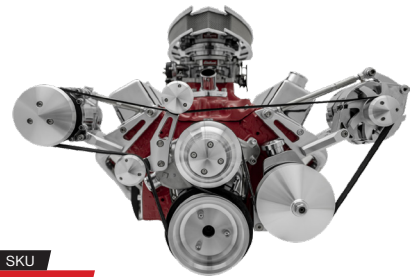

SKU  
20512

**KIT DETAILS**

- » Price includes brackets, pulleys and hardware.
- » AC kits require reverse rotation short water pump w/ 5.75" hub height (March #P2125).
- » Non-AC kits require standard rotation short water pump w/ 5.75" hub height (March #P2131).



APPLICATION	KIT CODE	
AC, PS & ALT <small>Saginaw Keyway; 7176 AC</small>	23690-09	<b>M</b> \$1299. <sup>95</sup>
AC & ALT <small>7176 AC</small>	23685-09	<b>M</b> \$1199. <sup>95</sup>
PS & ALT <small>Saginaw Keyway</small>	23695-09	<b>M</b> \$899. <sup>95</sup>
ALTERNATOR ONLY	23680-09	<b>M</b> \$599. <sup>95</sup>

MID-MOUNT SPORT TRACK » LONG WATER PUMP

**CUSTOM SERVICES**

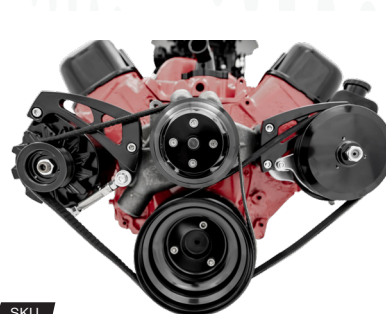

SKU  
23695-08

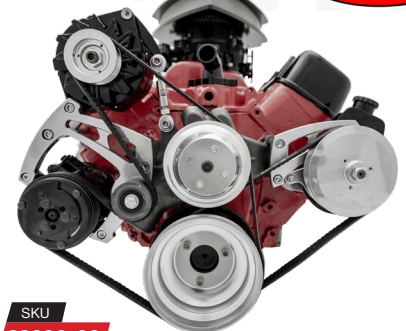

SKU  
23690-09

**KIT DETAILS**

- » Price includes new water pump, alternator, power steering pump, brackets, pulleys & hardware.





### SERPENTINE PULLEY KITS

PULLEY KIT	WATER PUMP TYPE	PULLEY RATIO	WATER PUMP PULLEY (1V)		CRANKSHAFT PULLEY		ALT. PULLEY (1V)		PS PULLEY KEYWAY/PRESS
7670 <b>\$269</b>	SHORT	HIGHFLOW	7622 (5.25")	<b>\$129</b>	1V	7671 (7")	<b>\$119</b>	208 <b>\$61</b>	
7610 <b>\$257</b>	SHORT	PERFORMANCE	6212 (6.25")	<b>\$117</b>	1V	7611 (5.75")	<b>\$94</b>	208 <b>\$61</b>	
7330 <b>\$252</b>	LONG	HIGHFLOW	6322 (5.25")	<b>\$117</b>	2V	7331 (7")	<b>\$112</b>	208 <b>\$61</b>	623/624
7310 <b>\$263</b>	LONG	HIGHFLOW	6322 (5.25")	<b>\$117</b>	1V	7311 (7")	<b>\$111</b>	208 <b>\$61</b>	
7640 <b>\$258</b>	LONG	MID-PERFORMANCE	6322 (5.25")	<b>\$117</b>	2V	7231 (5.75")	<b>\$120</b>	208 <b>\$61</b>	623/624
7635 <b>\$279</b>	LONG	MID-PERFORMANCE	6322 (5.25")	<b>\$117</b>	1V	7211 (5.75")	<b>\$104</b>	208 <b>\$61</b>	
7630 <b>\$267</b>	LONG	PERFORMANCE	6312 (6.25")	<b>\$114</b>	2V	7231 (5.75")	<b>\$120</b>	208 <b>\$61</b>	623/624
7210 <b>\$264</b>	LONG	PERFORMANCE	6312 (6.25")	<b>\$114</b>	1V	7211 (5.75")	<b>\$104</b>	208 <b>\$61</b>	

- » March Performance recommends High Flow for most applications
- » Pulley kits include water pump, crank and alternator pulley. Power steering pulleys are sold separately.

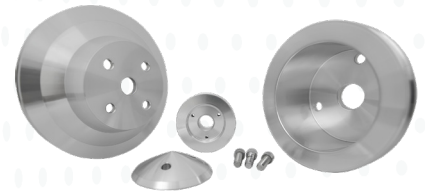

### V-BELT PULLEY KITS

PULLEY KIT	WATER PUMP TYPE	PULLEY RATIO	WATER PUMP PULLEY		CRANKSHAFT PULLEY		ALT. PULLEY (1V)		PS PULLEY KEYWAY/PRESS
7750 <b>\$279</b>	SHORT	HIGHFLOW	2V	7532 (6.25") <b>\$123</b>	3V	7751 (7") <b>\$131</b>	137 (2.69") <b>\$56</b>		
7730 <b>\$262</b>	SHORT	HIGHFLOW	2V	7532 (6.25") <b>\$123</b>	2V	7731 (7") <b>\$126</b>	137 (2.69") <b>\$56</b>		
7710 <b>\$260</b>	SHORT	HIGHFLOW	1V	7512 (6.25") <b>\$106</b>	1V	7711 (7") <b>\$104</b>	137 (2.69") <b>\$56</b>		
7550 <b>\$276</b>	SHORT	PERFORMANCE	2V	7532 (6.25") <b>\$123</b>	3V	7551 (5.5") <b>\$112</b>	137 (2.69") <b>\$56</b>		
7530 <b>\$251</b>	SHORT	PERFORMANCE	2V	7532 (6.25") <b>\$123</b>	2V	7531 (5.5") <b>\$110</b>	137 (2.69") <b>\$56</b>		
7510 <b>\$236</b>	SHORT	PERFORMANCE	1V	7512 (6.25") <b>\$106</b>	1V	7511 (5.5") <b>\$89</b>	137 (2.69") <b>\$56</b>		
7150 <b>\$272</b>	LONG	HIGHFLOW	1V	6152 (5.5") <b>\$113</b>	3V	7141 (7") <b>\$124</b>	137 (2.69") <b>\$56</b>	521/520	
7140 <b>\$270</b>	LONG	HIGHFLOW	2V	6092 (6.25") <b>\$106</b>	3V	7141 (7") <b>\$124</b>	137 (2.69") <b>\$56</b>	521/520	
7115 <b>\$262</b>	LONG	HIGHFLOW	1V	6152 (5.5") <b>\$113</b>	2V	7121 (7") <b>\$115</b>	137 (2.69") <b>\$56</b>	513/531	
7105 <b>\$261</b>	LONG	HIGHFLOW	1V	6152 (5.5") <b>\$113</b>	1V	7106 (7") <b>\$111</b>	137 (2.69") <b>\$56</b>		
7050 <b>\$255</b>	LONG	PERFORMANCE	1V	6052 (6.25") <b>\$119</b>	3V	7041 (5.5") <b>\$102</b>	137 (2.69") <b>\$56</b>	521/520	
7040 <b>\$259</b>	LONG	PERFORMANCE	2V	6092 (6.25") <b>\$106</b>	3V	7041 (5.5") <b>\$102</b>	137 (2.69") <b>\$56</b>	521/520	
7020 <b>\$249</b>	LONG	PERFORMANCE	2V	6092 (6.25") <b>\$106</b>	2V	7021 (5.5") <b>\$101</b>	137 (2.69") <b>\$56</b>	513/531	
7015 <b>\$251</b>	LONG	PERFORMANCE	1V	6052 (6.25") <b>\$119</b>	2V	7021 (5.5") <b>\$101</b>	137 (2.69") <b>\$56</b>	513/531	
7005 <b>\$259</b>	LONG	PERFORMANCE	1V	6052 (6.25") <b>\$119</b>	1V	7006 (5.5") <b>\$92</b>	137 (2.69") <b>\$56</b>		

- » March Performance recommends high flow for most applications
- » Power steering pulleys are not included in kit price.

ALT. BRACKETS	KIT CODE	
<b>ULTRA SERIES</b> Mid-mount, passenger side, LWP	20127	<b>M</b> \$99.95
<b>ULTRA SERIES</b> High mount, passenger side, LWP	20125	<b>M</b> \$108.95
<b>ULTRA SERIES</b> Inward mount, driver's side, SWP	20601	<b>M</b> \$199.95
<b>DELUXE SERIES</b> Low-mount, driver's side, SWP	20315	<b>M</b> \$158.95
<b>DELUXE SERIES</b> Outward mount, driver's side, SWP	20135	<b>M</b> \$180.95
<b>ULTRA SERIES</b> Mid-mount, passenger side, EWP	23003	<b>M</b> \$188.95
<b>REAR SUPPORT</b> Tall deck engines, use w/ 20127	20123	<b>M</b> \$99.95
<b>REAR SUPPORT</b> Tall deck engines	20128-09	<b>M</b> \$79.95

## ALTERNATOR BRACKETS

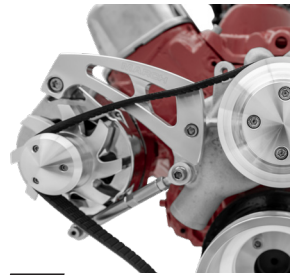

SKU  
20127

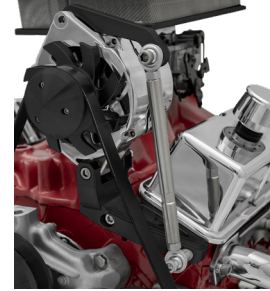

SKU  
20601-08

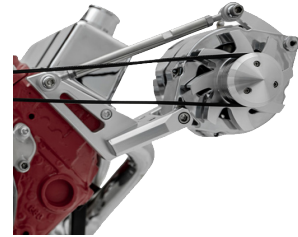

SKU  
20135



PS. BRACKETS	KIT CODE	
<b>ULTRA SERIES</b> Mid-mount, Saginaw, LWP	20150	<b>M</b> \$129.95
<b>ULTRA SERIES</b> Mid-mount extra high, Saginaw, LWP	20151	<b>M</b> \$142.95
<b>ULTRA SERIES</b> Mid-mount, Saginaw, EWP	23004	<b>M</b> \$213.95

## POWER STEERING BRACKETS



SKU  
20150



SKU  
20151-08

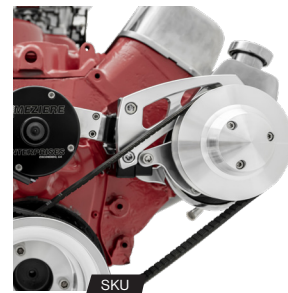

SKU  
23004



A/C BRACKETS	KIT CODE	
<b>ULTRA SERIES</b> Inward mount, 508 Sanden style, passenger, SWP	20602	<b>M</b> \$195.95
<b>ULTRA SERIES</b> Outward mount, 508 Sanden style, passenger, SWP	20205	<b>M</b> \$299.95

## AIR CONDITIONING BRACKETS

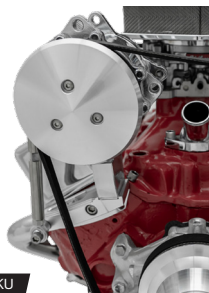

SKU  
20602

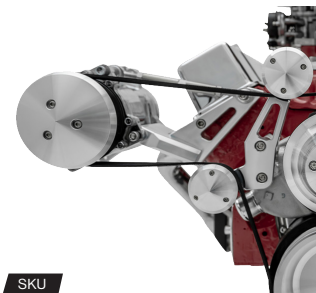

SKU  
20205



## EVOLUTION

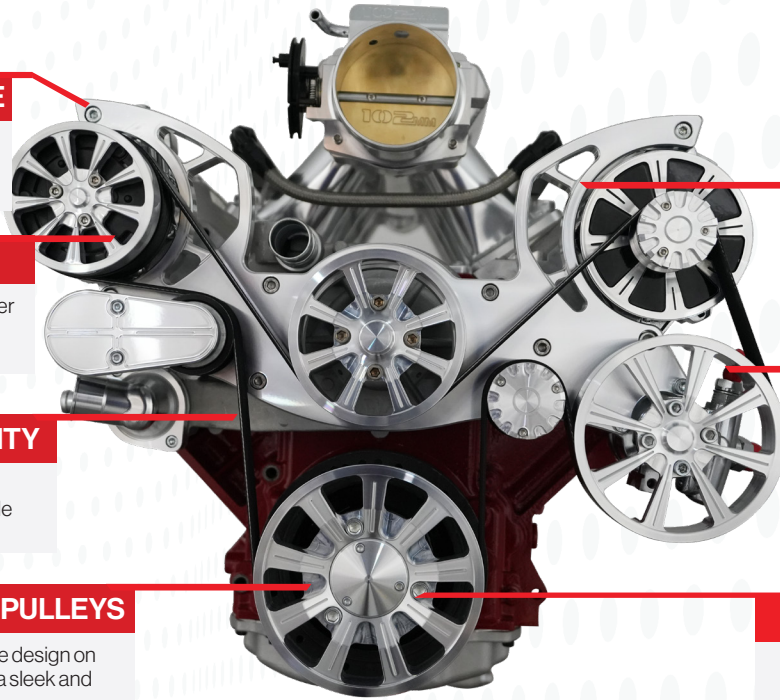

**M TOP OF THE LINE**

All stainless steel hardware and coated billet spacers.

**M TENSIONER**

Spring loaded belt tensioner with patent pending mounting adjustability.

**M COMPATIBILITY**

Endless compatibility options including multiple balancers and VVT.

**M SPOKE PULLEYS**

Premium spoke design on our pulleys for a sleek and modern style.

**PATENT PENDING**

**SINGLE BRACKET M**

Extra thick single mounting bracket prevents deflection in even the highest horsepower builds.

**PS PUMP OPTIONS M**

Choose from 4 different power steering options:  
 GM Type II w/Remote Reservoir  
 GM Type II w/Attached Reservoir  
 Hydroboost w/Remote Reservoir  
 Hydroboost w/Attached Reservoir

**ADJUST TIMING M**

Removable cap to adjust timing without the need to remove the entire crankshaft pulley.

### BLACK ONYX

### BLACK

### CLEAR

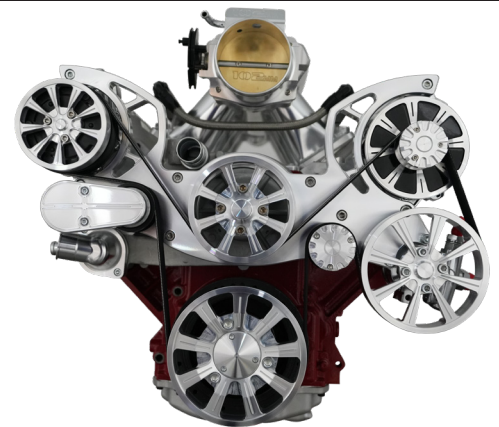
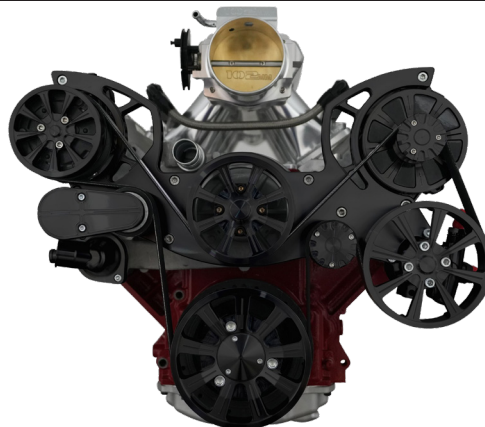
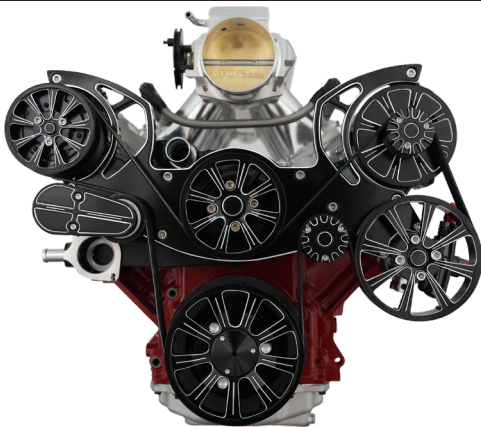

**M KIT PRICE: \$2995.00**

BLACK ONYX

**LSX-EV-AC-87**  
AC, Power Steering & Alternator

**M KIT PRICE: \$2795.00**

BLACK

**LSX-EV-AC-88**  
AC, Power Steering & Alternator

**M KIT PRICE: \$2795.00**

CLEAR

**LSX-EV-AC**  
AC, Power Steering & Alternator

**AVAILABLE IN 4 CONFIGURATIONS:** 1 AC + Power Steering + Alt. 2 AC + Alt. 3 Power Steering + Alt. 4 Alternator Only

#### TECHNICAL SPECIFICATIONS

Includes hub adapter to work with OEM, ATI & SFI Balancers. \*Evolution Exclusive\*  
 4 Power Steering options including hydroboost \*Evolution Exclusive\*  
 Remote reservoir included w/ purchase. \*Evolution Exclusive\*  
 Compatible with Variable Valve Timing (VVT). \*Evolution Exclusive\*  
 Includes 140 AMP Alternator - upgradeable to 300AMP.



**SCAN THE CODE TO VIEW CHEVY LS EVOLUTION KITS**



APPLICATION	KIT CODE	
AC, PS & ALT Wide Mount, GM Type II Remote	20060	<b>M</b> \$1999. <sup>95</sup>
AC, PS & ALT Narrow Mount, GM Type II Remote	20065	<b>M</b> \$2299. <sup>95</sup>
AC & ALT Wide Mount	20070	<b>M</b> \$2199. <sup>95</sup>
AC & ALT Narrow Mount	20075	<b>M</b> \$2199. <sup>95</sup>
PS & ALT Wide Mount, GM Type II Remote	20050	<b>M</b> \$2199. <sup>95</sup>
ALTERNATOR ONLY Wide Mount	20040	<b>M</b> \$902. <sup>95</sup>
AC, PS & ALT Revolver Style, Wide Mount, GM Type II Remote	20077	<b>M</b> \$2299. <sup>95</sup>
AC & ALT Revolver Style, Wide Mount	20076	<b>M</b> \$2199. <sup>95</sup>



### KIT DETAILS

» Price includes new water pump, alternator, power steering pump, AC compressor, brackets, pulleys and hardware. Belt, hub adapter & remote reservoir not included.

APPLICATION	KIT CODE	
AC, PS & ALT GM Type II Remote	20035	<b>M</b> \$1995. <sup>95</sup>
AC, PS & ALT Custom Series - cast accessories, no covers	20095-08	<b>M</b> \$1699. <sup>95</sup>
PS & ALT GM Type II Remote	20025	<b>M</b> \$1895. <sup>95</sup>
PS & ALT Custom Series - cast accessories, no covers	20085-08	<b>M</b> \$1499. <sup>95</sup>
AC & ALT	20030	<b>M</b> \$1895. <sup>95</sup>
AC & ALT Custom Series - cast accessories, no covers	20090-08	<b>M</b> \$1499. <sup>95</sup>
ALTERNATOR ONLY	20020	<b>M</b> \$1795. <sup>95</sup>
ALTERNATOR ONLY Value line - cast accessories, no covers	20080-08	<b>M</b> \$1299. <sup>95</sup>

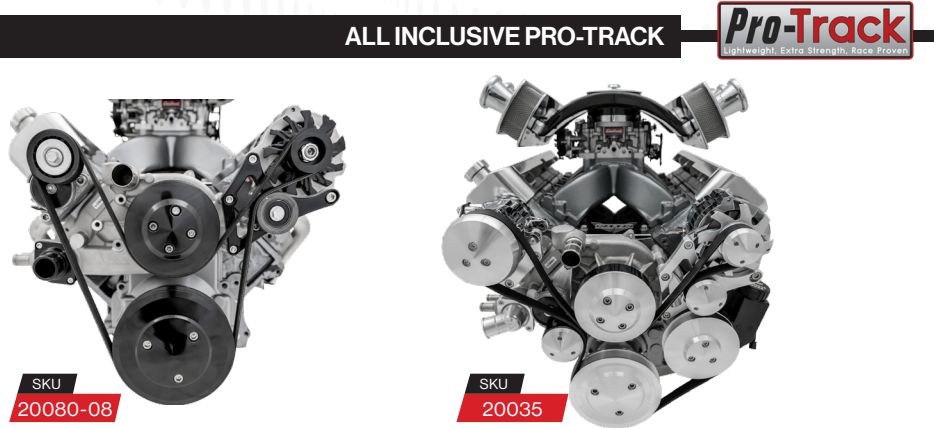

### KIT DETAILS

» Price includes new water pump, alternator, power steering pump, AC compressor, brackets, pulleys and hardware. Belt, hub adapter & remote reservoir not included.  
» Custom series is only available in black.

APPLICATION	KIT CODE	
AC, PS & ALT Wide Mount, GM Type II Remote PS	19915-09	<b>M</b> \$1795. <sup>95</sup>
AC & ALT Wide Mount	19905-09	<b>M</b> \$1695. <sup>95</sup>
AC, PS & ALT Narrow mount, GM Type II Attached	19925-08	<b>M</b> \$1299. <sup>95</sup>
PS & ALT Narrow mount, GM Type II Attached	19920-08	<b>M</b> \$842. <sup>95</sup>



### KIT DETAILS

» Removes decorative caps and pulleys for a lower cost  
» Price includes new water pump, alternator, power steering pump, AC compressor, brackets, pulleys and hardware. Belt and remote reservoir not included.

### ULTRA

#### MID-MOUNT ULTRA SERIES

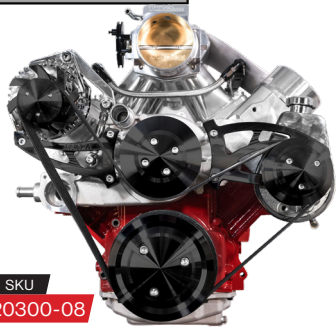

SKU  
20300-08

SKU  
20335

#### KIT DETAILS

- » Price for clockwise rotation kits (20335-20345) is for brackets, pulleys & hardware. Kit requires the use of Edelbrock 8895 water pump; not included.
- » Price for counter-clockwise rotation kits (20300-20310) include water pump, brackets, pulleys & hardware. Alternator and power steering pump not included.
- » Not Compatible w/ Variable Valve Timing (VVT).
- » Kits compatible w/ Camaro/Firebird (4.875"), Corvette (4.125"), and LS7. All options require hub adapter (not included)

APPLICATION	KIT CODE	
<b>AC, PS &amp; ALT</b> Clockwise Rotation, Saginaw Keyway	20335	<b>M</b> \$1010. <sup>95</sup>
<b>PS &amp; ALT</b> Clockwise Rotation, Saginaw Keyway	20345	<b>M</b> \$785. <sup>95</sup>
<b>ALTERNATOR ONLY</b> Clockwise Rotation	20340	<b>M</b> \$545. <sup>95</sup>
<b>PS &amp; ALT</b> Counter-clockwise Rotation, Saginaw Keyway	20300	<b>M</b> \$752. <sup>95</sup>
<b>PS &amp; ALT</b> Counter-clockwise Rotation, GM Type II Remote	20310	<b>M</b> \$752. <sup>95</sup>

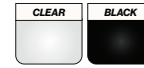

#### Optional Add-on Accessories:

- » Saginaw style power steering pump.

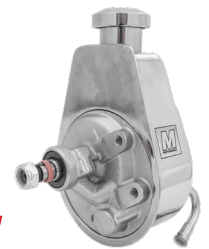

SKU  
P2304

#### ADDITIONAL LS PRODUCTS



AC bracket for R4 compressors w/ 4" clutch. Mounts high on the US passenger side. Trucks only. Available in black and clear.

SKU  
24132 **M** \$235.<sup>00</sup>



LS1 Fluid Damper for '98-01 Camaro and Firebird. Underdriven. Requires factory set up.

SKU  
P4521-08 **M** \$257.<sup>95</sup>



Valley cover (smooth or pocketed) for Gen III Chevy LS engines. Available in polished, black and clear.

SKU  
MLSG3-VAC **M** \$84.<sup>95</sup>



Valley cover (smooth or pocketed) for Gen IV Chevy LS engines. Available in polished, black and clear.

SKU  
MLSG4-VAC **M** \$124.<sup>95</sup>

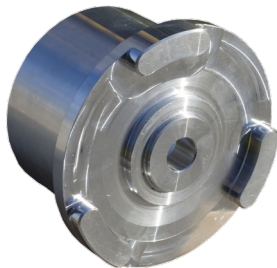

Hub adapter for Chevy LS serpentine systems. For use w/ Camaro, Firebird and truck balancers. 4.875" block to face of balancer. Polished.

SKU  
355-04 **M** \$92.<sup>95</sup>

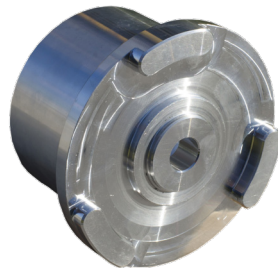

Hub adapter for Chevy LS serpentine systems. For use w/ Corvette balancers. 4.125" block to face of balancer. Polished.

SKU  
358-04 **M** \$92.<sup>95</sup>

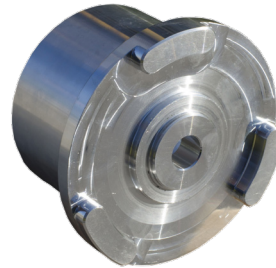

Hub adapter for Chevy LS serpentine systems. For use w/ LS7 balancers. Polished.

SKU  
356-04 **M** \$92.<sup>95</sup>



Billet thermostat housing w/ swivel base for Chevy LS water pumps from 2004-2009 & Edelbrock #8896. Various angles & finishes.

SKU  
LS-WN **M** \$134.<sup>95</sup>

## EVOLUTION

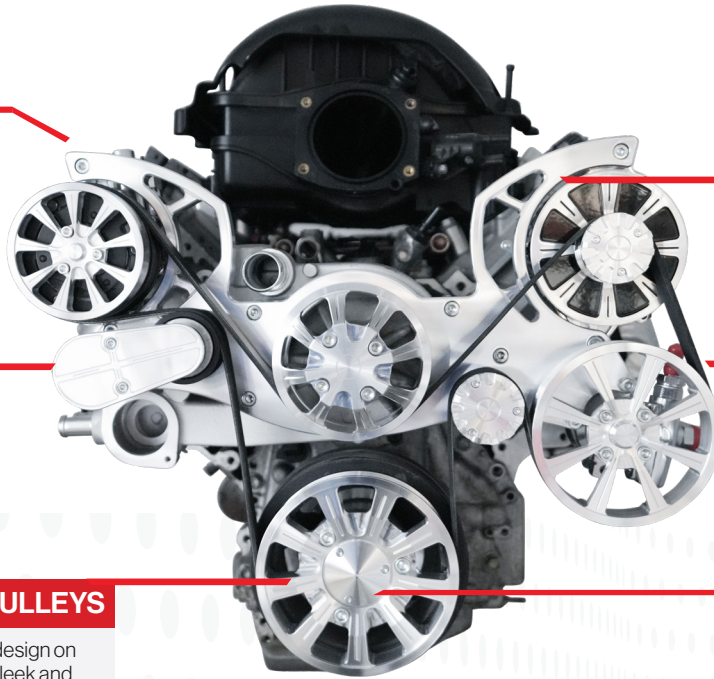

**M TOP OF THE LINE**

All stainless steel hardware and coated billet spacers.

**PATENT PENDING**

**SINGLE BRACKET M**

Extra thick single mounting bracket prevents deflection in even the highest horsepower builds.

**M TENSIONER**

Spring loaded belt tensioner with patent pending mounting adjustability.

**PS PUMP OPTIONS M**

Choose from 4 different power steering options:  
 GM Type II w/Remote Reservoir  
 GM Type II w/Attached Reservoir  
 Hydroboost w/Remote Reservoir  
 Hydroboost w/Attached Reservoir

**M SPOKE PULLEYS**

Premium spoke design on our pulleys for a sleek and modern style.

**ADJUST TIMING M**

Removable cap to adjust timing without the need to remove the entire crankshaft pulley.

**BLACK ONYX**

**BLACK**

**CLEAR**

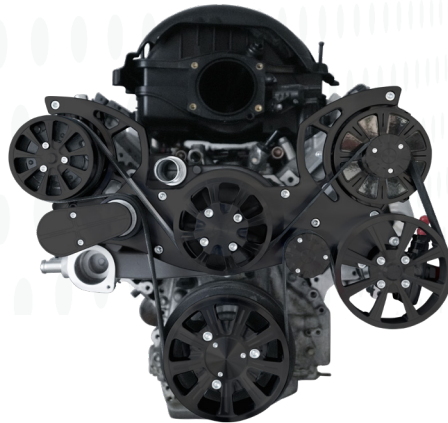

**M KIT PRICE: \$3182.00**

BLACK ONYX

**LT1V-EV-AC-07**  
AC, Power Steering & Alternator

**M KIT PRICE: \$2995.00**

BLACK

**LT1V-EV-AC-08**  
AC, Power Steering & Alternator

**M KIT PRICE: \$2995.00**

CLEAR

**LT1V-EV-AC**  
AC, Power Steering & Alternator

**AVAILABLE IN 4 CONFIGURATIONS:** 1 AC + Power Steering + Alt. 2 AC + Alt. 3 Power Steering + Alt. 4 Alternator Only

**TECHNICAL SPECIFICATIONS**

Includes hub adapter to work with OEM, ATI & SFI Balancers. *\*Evolution Exclusive\**  
 4 Power Steering including hydroboost Remote reservoir included w/ purchase. *\*Evolution Exclusive\**  
 Compatible with Variable Valve Timing (VVT). *\*Evolution Exclusive\**  
 Includes 140 AMP Alternator - upgradeable to 300AMP.  
 Utilizes 8-Rib Serpentine belt (included).



**SCAN THE CODE TO VIEW CHEVY LS EVOLUTION KITS**



### ALL INCLUSIVE STYLE TRACK

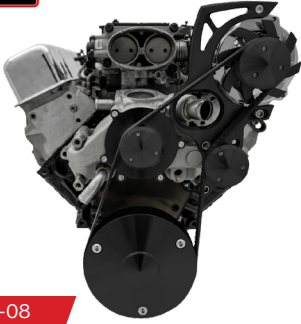

SKU  
20970-08

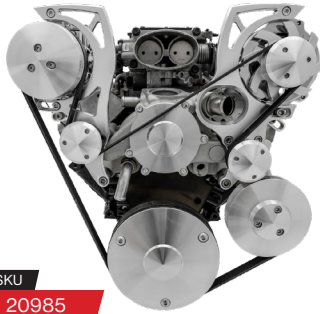

SKU  
20985

#### KIT DETAILS

- » Price includes alternator, power steering pump, AC compressor, brackets, pulleys, and hardware.
- » Hub adapter for Corvette, Camaro/Firebird and Impala balancers sold separately.



APPLICATION	KIT CODE	
<b>AC, PS &amp; ALT</b> GM Type II Pump w/ Remote Reservoir	20985	<b>M</b> \$1899.95
<b>PS &amp; ALT</b> GM Type II Pump w/ Remote Reservoir	20975	<b>M</b> \$1799.95
<b>AC &amp; ALT</b>	20980	<b>M</b> \$1799.95
<b>ALTERNATOR ONLY</b>	20970	<b>M</b> \$1699.95



### ULTRA SERIES SERPENTINE CONVERSION



SKU  
20920-08

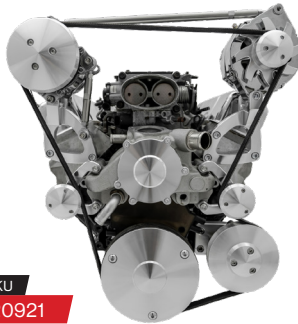

SKU  
20921

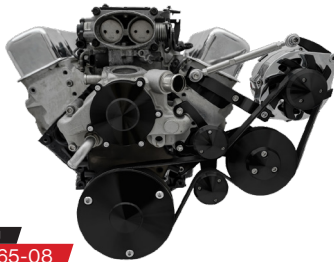

SKU  
20965-08



SKU  
20955

#### KIT DETAILS

- » Price includes brackets, pulleys and hardware.
- » Requires hub adapter for camaro/firebird or corvette. Not included.



APPLICATION	KIT CODE	
<b>AC, PS &amp; ALT</b> Outward mount, camaro balancer	20955	<b>M</b> \$1199.95
<b>AC, PS &amp; ALT</b> Outward mount, corvette balancer	20945	<b>M</b> \$1199.95
<b>PS &amp; ALT</b> Outward mount, camaro balancer	20965	<b>M</b> \$899.95
<b>PS &amp; ALT</b> Outward mount, corvette balancer	20935	<b>M</b> \$899.95
<b>AC &amp; ALT</b> Outward mount, camaro balancer	20950	<b>M</b> \$1099.95
<b>AC &amp; ALT</b> Outward mount, corvette balancer	20940	<b>M</b> \$1099.95
<b>ALTERNATOR ONLY</b> Outward mount, camaro balancer	20960	<b>M</b> \$699.95
<b>ALTERNATOR ONLY</b> Outward mount, corvette balancer	20930	<b>M</b> \$699.95
<b>AC, PS &amp; ALT</b> High mount, camaro balancer	20921	<b>M</b> \$999.95
<b>AC, PS &amp; ALT</b> High mount, corvette balancer	20911	<b>M</b> \$999.95
<b>AC &amp; ALT</b> High mount, camaro balancer	20920	<b>M</b> \$899.95
<b>AC &amp; ALT</b> High mount, corvette balancer	20910	<b>M</b> \$899.95

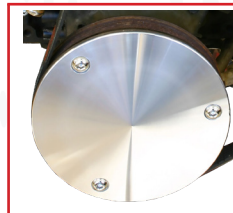

HUB ADAPTER	KIT CODE	
Corvette Balancers	349	<b>M</b> \$139.95
Camaro/Firebird Balancers	348	<b>M</b> \$139.95
Impala Balancers	343	<b>M</b> \$139.95

# CHEVY 409 & LATE MODELS

APPLICATION	KIT CODE	
<b>AC, PS &amp; ALT</b> Chrome accessories	21355	<b>M</b> \$2799. <sup>95</sup>
<b>AC &amp; ALT</b> Chrome accessories	21350	<b>M</b> \$2699. <sup>95</sup>
<b>PS &amp; ALT</b> Billet accessories	21390	<b>M</b> \$2998. <sup>95</sup>
<b>PS &amp; ALT</b> Chrome accessories	21385	<b>M</b> \$2699. <sup>95</sup>

## MID-MOUNT REVOLVER SERIES



SKU  
21390-07

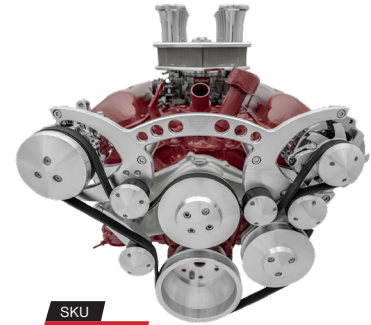

SKU  
21355



### KIT DETAILS

» Price includes new water pump, alternator, power steering pump, AC compressor, brackets, pulleys and hardware. Belt and remote reservoir not included.

## 348/409 V-BELT PULLEY KITS

APPLICATION	PULLEY KIT	WATER PUMP	CRANK PULLEY	ALT PULLEY
<b>ALTERNATOR ONLY</b> (5.5" water pump)	7905 <b>\$272</b>	1V 7902 (6.5") <b>\$119</b>	1V 7901 (6.75") <b>\$129</b>	1V 137 (2.34") <b>\$56</b>
<b>PS &amp; ALT</b> (5.5" water pump)	7915 <b>\$268</b>	2V 7912 (6.5") <b>\$119</b>	2V 7911 (6.75") <b>\$136</b>	1V 137 (2.34") <b>\$56</b>
<b>AC, PS &amp; ALT</b> (5.5" Water Pump)	7920 <b>\$291</b>	2V 7912 (6.5") <b>\$119</b>	3V 7921 (6.75") <b>\$139</b>	1V 137 (2.34") <b>\$56</b>

## LATE MODEL GM SERPENTINE PULLEYS

PULLEY KIT	ENGINE TYPE	APPLICATION	WATER PUMP PULLEY	CRANKSHAFT PULLEY	ALT. PULLEY (1V)	OPTIONAL PS PULLEY
4480 <b>\$239</b>	BIGBLOCK	TRUCK '88-97	1V 4012 <b>\$81</b>	1V 4361 <b>\$107</b>	112 <b>\$64</b>	
4475-08 <b>\$121</b>	BIGBLOCK	TRUCK '88-00		1V 4361-08 <b>\$107</b>	110-08 <b>\$27</b>	
4490 <b>\$234</b>	SMALL BLOCK	TRUCK '96-97	1V 4314 <b>\$81</b>	1V 4311 <b>\$132</b>	125 <b>\$49</b>	
4470 <b>\$249</b>	SMALL BLOCK	TRUCK '95	1V 4312 <b>\$76</b>	1V 4311 <b>\$132</b>	125 <b>\$49</b>	
4460-08 <b>\$139</b>	SMALL BLOCK	TRUCK '94-03		1V 4311-08 <b>\$132</b>	124-08 <b>\$28</b>	
4450 <b>\$234</b>	SMALL BLOCK	TRUCK '96-97	1V 4314 <b>\$81</b>	1V 4311 <b>\$132</b>	112 <b>\$64</b>	
4465 <b>\$232</b>	SMALL BLOCK	TRUCK '88-95	1V 4312 <b>\$76</b>	1V 4311 <b>\$132</b>	112 <b>\$64</b>	610
4455-08 <b>\$121</b>	SMALL BLOCK	TRUCK '88-03		1V 4311-08 <b>\$106</b>	110-08 <b>\$27</b>	610
4485 <b>\$132</b>	SMALL BLOCK	CAMARO '93-97		1V 4050 <b>\$112</b>	121-08 <b>\$34</b>	
4400-08 <b>\$121</b>	SMALL BLOCK	CAMARO '88-92		1V 4011-08 <b>\$111</b>	110-08 <b>\$27</b>	
4420 <b>\$250</b>	SMALL BLOCK	GM '85-87	2V 4032 <b>\$87</b>	3V 4031* <b>\$120</b>	112 <b>\$64</b>	522
4415-08 <b>\$139</b>	SMALL BLOCK	GM '85-87		3V 4031-08* <b>\$120</b>	110-08 <b>\$27</b>	522-08

### KIT DETAILS

- » March Performance late model pulleys are designed to fit factory applications.
- » Pulley 4031 has 2 V-Belt grooves and a 5 rib serpentine groove.\*
- » Additional pulley kits are available at marchperformance.com. Scan the QR code.



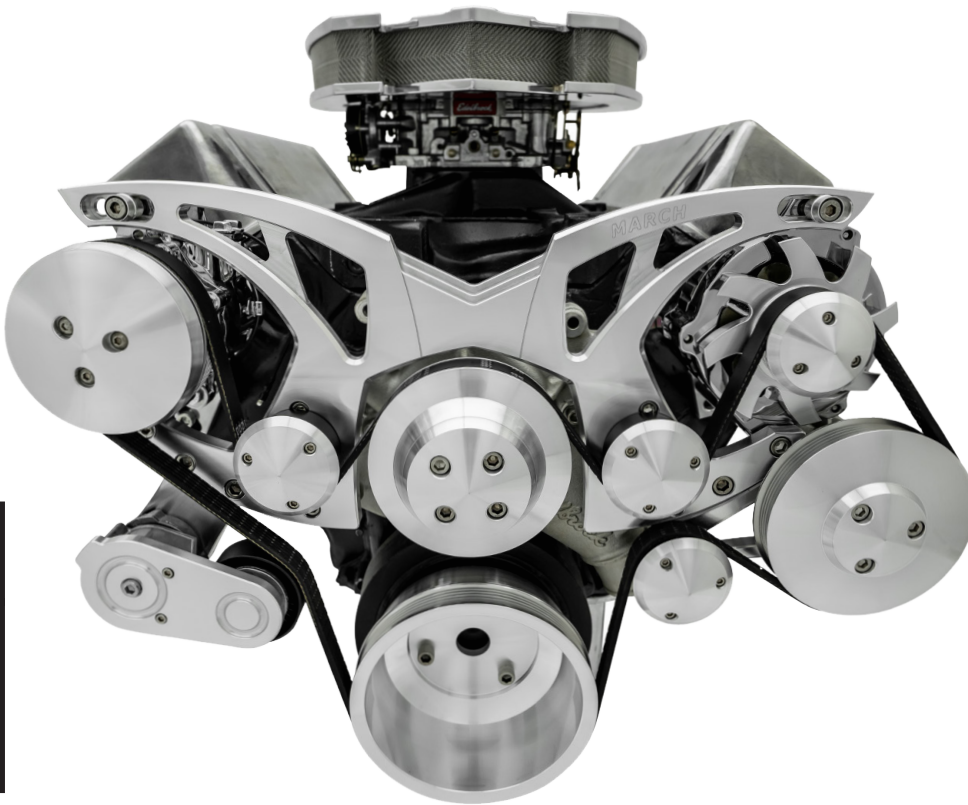

SCAN THE CODE BELOW FOR FORD KIT DETAILS, PRICING & AVAILABILITY



## KITS AND FINISH TYPES FOR FORD ENGINES

### EVOLUTION



### Stylized TRACK



### Pro-Track



### Revolver



### CUSTOM SERIES



## KEY FEATURES, DETAILS & TECHNICAL SPECIFICATIONS

### FEATURES

**KIT TYPES:** March offers serpentine, v-belt, and individual pulley & bracket kits.  
**ULTRA ACCESSORIES:** In addition, all kits have options for our March Ultra series accessories, including alternators, power steering pumps, water pumps & AC compressors.  
**LIFE TIME WARRANTY:** All March pulleys, brackets, engine accessories include an industry leading Lifetime Warranty.

### TECHNICAL DETAILS

**DIMENSIONS & COMPATIBILITY:** Visit [marchperformance.com](http://marchperformance.com) for full details.  
**TECH SUPPORT:** All March products include free support for the life time of the product. Call 1.888.729.9070 or email [info@marchperformance.com](mailto:info@marchperformance.com).

**PG** ENGINE TYPE  
**31** SMALL BLOCK  
**38** 351 CLEVELAND  
**40** BIG BLOCK  
**41** MOD MOTORS  
**42** FE  
**43** FLATHEAD  
**43** COYOTE

APPLICATION	KIT CODE	
AC, PS & ALT GM Type II Pump w/ Remote Reservoir	302-EV-AC	<b>M</b> \$2995.00
PS & ALT GM Type II Pump w/ Remote Reservoir	302-EV-PS	<b>M</b> \$2895.00
AC & ALT	302-EV-ACO	<b>M</b> \$2895.00
ALTERNATOR ONLY	302-EV-ALT	<b>M</b> \$2795.00

## ALL INCLUSIVE MID-MOUNT EVOLUTION SERIES **EVOLUTION**



SKU  
302-EV-AC-07



SKU  
302-EV-ACO

**PATENT PENDING**



### KIT DETAILS

- » Price includes new water pump, alternator, power steering pump, AC compressor, brackets, pulleys, remote reservoir, belt and hardware.
- » Kit is compatible with early, late, and extra short Ford water pumps.
- » Kit is compatible with OEM and aftermarket 3 or 4 bolt balancers.
- » Optional upgrades include 300 AMP alternator or hydroboost compatible power steering.

APPLICATION	KIT CODE	
AC, PS & ALT GM Type II Pump w/ Remote Reservoir	30490	<b>M</b> \$2195.95
AC & ALT Timing Cover Included	30485	<b>M</b> \$2095.95
AC, PS & ALT GM Type II Pump w/ Remote Reservoir	30810	<b>M</b> \$1999.95
AC & ALT	30805	<b>M</b> \$1899.95

## MID-MOUNT | REVERSE ROTATION SHORT WATER PUMP

*Style*  
**TRACK**



SKU  
30805-07



SKU  
30490



### KIT DETAILS

- » Kits 30490 & 30485 are based on '94-'95 Mustangs and include a new timing cover and short water pump; require electric fuel pump.
- » Kits 30810 & 30805 are based on '87-'93 Mustangs (5.0/5.8L) and include a new water pump.
- » Requires 4 bolt factory balancer

APPLICATION	KIT CODE	
AC, PS & ALT GM Type II Pump w/ Remote Reservoir	30470	<b>M</b> \$1999.95
AC & ALT	30465	<b>M</b> \$1899.95

## MID-MOUNT | REVERSE ROTATION SHORT WATER PUMP

**Revolver**



SKU  
30465-08



SKU  
30470



**QUESTIONS?**  
CONTACT OUR WORLD CLASS SUPPORT TEAM  
**(888) 729-9070**



### KIT DETAILS

- » Price includes new water pump, alternator, power steering pump, AC compressor, brackets, pulleys and hardware. Belt and remote reservoir not included.
- » Based on 1994-'95 Ford Mustang engines
- » Requires 90° thermostat housing and electric fuel pump

**Pro-Track**  
Lightweight, Extra Strength, Race Proven

## MID-MOUNT | REVERSE ROTATION SHORT WATER PUMP

### APPLICATION

### KIT CODE

PS & ALT  
Saginaw Pump w/Keyway

30480 **M** \$1899.95



SKU  
30480-07

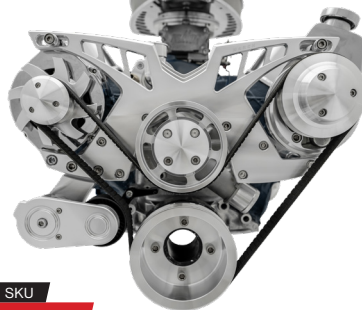

SKU  
30480

### Optional Add-on Accessories:

» Carbon Spider Fuelie billet air cleaner.



SKU  
9870-07

### KIT DETAILS

- » Price includes new water pump, alternator, power steering pump, brackets, pulleys and hardware. Belt not included.
- » Requires electric fuel pump.



**CUSTOM**  
SERIES

## MID-MOUNT | REVERSE ROTATION SHORT WATER PUMP

### APPLICATION

### KIT CODE

AC, PS & ALT  
GM Type II Pump w/Remote Reservoir

CS30810 **M** \$1399.95

AC & ALT

CS30805 **M** \$1299.95



SKU  
CS30810-08



SKU  
CS30810

### Optional Add-on Accessories:

» Remote reservoir for Gm Type II power steering pumps.



SKU  
450

### KIT DETAILS

- » Price includes water pump, alternator, power steering pump, brackets, pulleys and hardware.
- » Based on 1987-93 ford reverse rotation water (included).
- » Requires 90° thermostat housing.
- » Value line. Does not include decorative caps.



**M**  
PERFORMANCE

**LIFETIME WARRANTY**

## ULTRA ACCESSORIES



**+MORE!**

To view all of our accessories visit the Accessories section in the back of the catalog.



APPLICATION	KIT CODE		
<b>AC, PS &amp; ALT</b> Late WP, 289-302, 4 Bolt, Saginaw PS	30183	<b>M</b>	\$699. <sup>95</sup>
<b>AC, PS &amp; ALT</b> Late WP, 351W, 4 Bolt, Saginaw PS	30383	<b>M</b>	\$929. <sup>95</sup>
<b>AC, PS &amp; ALT</b> Early WP, 289-302, 3 Bolt, Saginaw PS	30163	<b>M</b>	\$899. <sup>95</sup>
<b>AC, PS &amp; ALT</b> Early WP, 289-302, 3 Bolt, Ford PS	30166	<b>M</b>	\$899. <sup>95</sup>
<b>AC &amp; ALT</b> Late WP, 289-302, 4 Bolt	30181	<b>M</b>	\$699. <sup>95</sup>
<b>AC &amp; ALT</b> Early WP, 289-302, 3 Bolt	30161	<b>M</b>	\$699. <sup>95</sup>
<b>PS &amp; ALT</b> Late WP, 289-302, 4 Bolt, Saginaw PS	30182	<b>M</b>	\$699. <sup>95</sup>
<b>PS &amp; ALT</b> Early WP, 289-302, 3 Bolt, Saginaw PS	30162	<b>M</b>	\$699. <sup>95</sup>
<b>ALTERNATOR ONLY</b> Late WP, 289-302, 4 Bolt	30180	<b>M</b>	\$499. <sup>95</sup>
<b>ALTERNATOR ONLY</b> Early WP, 289-302, 3 Bolt	30160	<b>M</b>	\$499. <sup>95</sup>

## ULTRA SERIES SERPENTINE CONVERSION

**ULTRA**

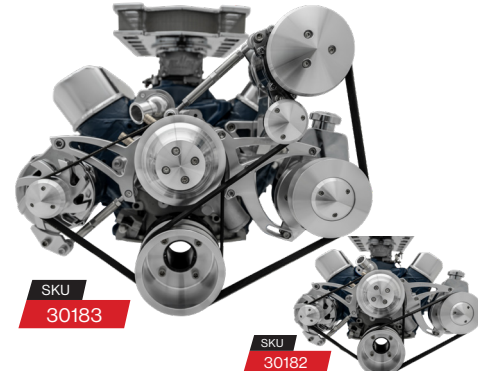
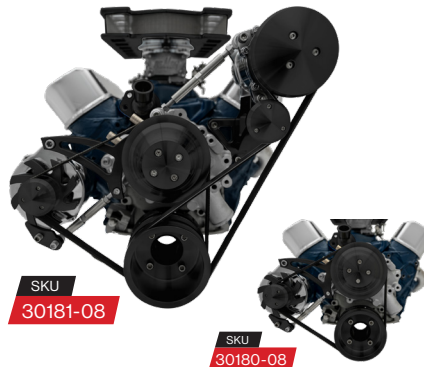

6-RIB SERPENTINE



### KIT DETAILS

- » Prices include all brackets, pulleys & hardware.
- » Late water pump has driver's side lower radiator hose (March #P2162).
- » Early water pump has passenger side lower radiator hose (March #P2141).
- » All AC applications require use of Sanden style 508 compressor (March #P2413).
- » For full details and customization options visit [marchperformance.com](http://marchperformance.com).

APPLICATION	KIT CODE		
<b>AC, PS &amp; ALT</b> 289-302, Saginaw Keyway	30168	<b>M</b>	\$784. <sup>95</sup>
<b>AC, PS &amp; ALT</b> 289-302, GM Type II Remote PS	30169	<b>M</b>	\$784. <sup>95</sup>
<b>AC, PS &amp; ALT</b> 289-302, Ford Mustang PS	30167	<b>M</b>	\$784. <sup>95</sup>
<b>PS &amp; ALT</b> 289-302, Saginaw Keyway	30127	<b>M</b>	\$599. <sup>95</sup>
<b>PS &amp; ALT</b> 289-302, GM Type II Remote PS	30124	<b>M</b>	\$599. <sup>95</sup>
<b>PS &amp; ALT</b> 289-302, Ford Mustang PS	30126	<b>M</b>	\$599. <sup>95</sup>

## ULTRA SERIES MID-MOUNT SERPENTINE CONVERSION

**ULTRA**

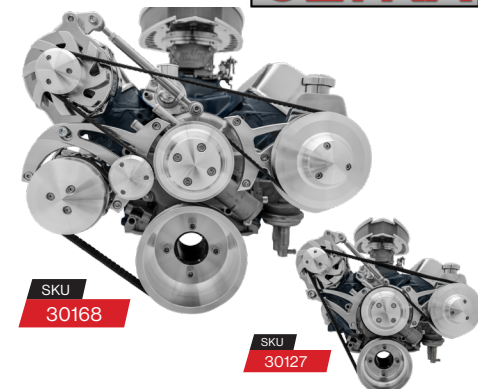
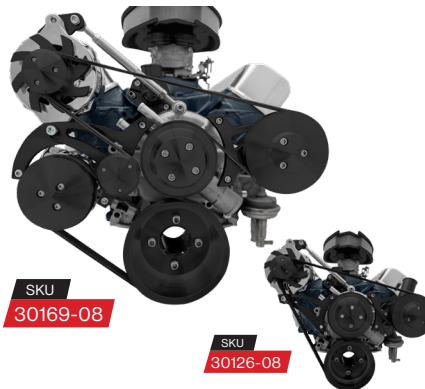

### Optional Add-on Accessories:

- » Reverse rotation water pump. Available in as cast, black or chrome.

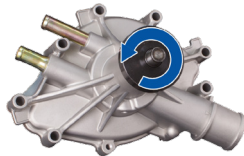

SKU  
**P2173**



6-RIB SERPENTINE

### KIT DETAILS

- » Prices include all brackets, pulleys & hardware.
- » Replace the "1" in sku with a "3" for 351 Windsor applications.
- » Require 1979-93 reverse rotation water pump (March #P2173) and 4 bolt factory balancer.
- » All AC applications require use of peanut style 7176 compressor (March #P2412).
- » For full details and customization options visit [www.marchperformance.com](http://www.marchperformance.com).



### DELUXE DELUXE SERIES SERPENTINE CONVERSION

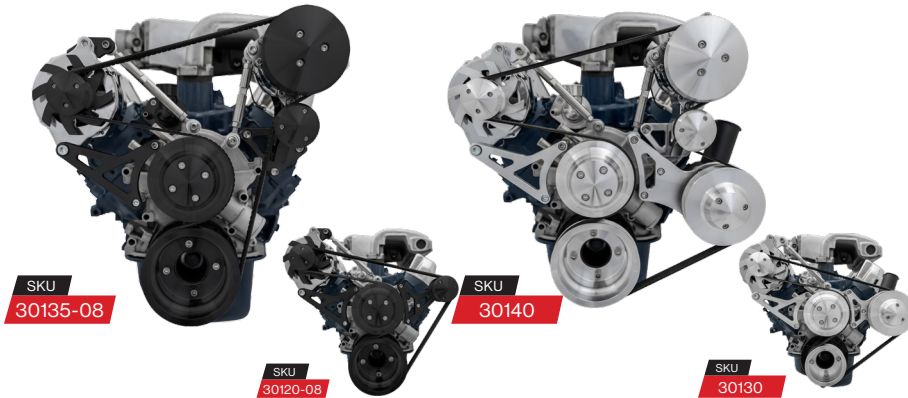

#### KIT DETAILS

- » Prices include brackets, pulleys & hardware.
- » Requires reverse rotation water pump from 1979-1993 (March # P2173).
- » Requires 4 bolt factory balancer & 90° thermostat housing (March BTH-302).
- » AC applications require Sanden style 508 compressor (March # P2413).

APPLICATION	KIT CODE	PRICE
AC, PS & ALT Ford Power Steering, High Flow, 289-302	30140	<b>M</b> \$799.95
AC, PS & ALT Ford Power Steering, High Flow, 351W	30330	<b>M</b> \$829.95
AC & ALT 289-302; High Flow	30135	<b>M</b> \$599.95
AC & ALT 351W; High Flow	30335	<b>M</b> \$629.95
PS & ALT Ford Power Steering, High Flow, 289-302	30125	<b>M</b> \$599.95
PS & ALT Ford Power Steering, High Flow, 351W	30325	<b>M</b> \$629.95
PS & ALT Ford Power Steering, Performance, 289-302	30130	<b>M</b> \$599.95
PS & ALT Ford Power Steering, Performance, 351W	30320	<b>M</b> \$629.95
ALTERNATOR ONLY 289-302; High Flow	30120	<b>M</b> \$499.95
ALTERNATOR ONLY 351W; High Flow	30315	<b>M</b> \$529.95
ALTERNATOR ONLY 289-302; Performance Ratio	30115	<b>M</b> \$499.95



### ULTRA SERPENTINE CONVERSION - ELECTRIC WATER PUMP

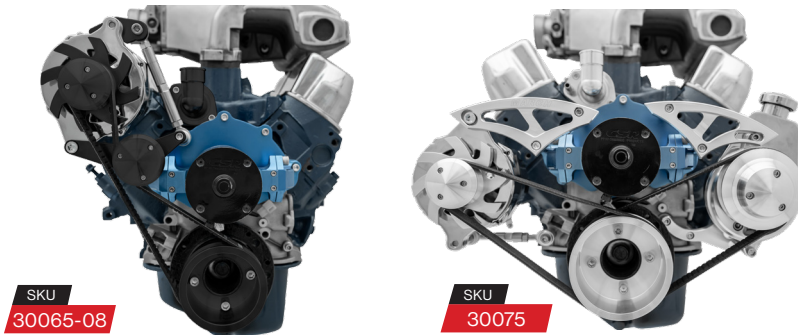

#### KIT DETAILS

- » Price includes brackets, pulleys and hardware.
- » Requires CSR or CSI electric water pumps.
- » Requires electric fuel pump.
- » Power steering applications require saginaw keyway power steering pump (March #P2304).

APPLICATION	KIT CODE	PRICE
PS & ALT Saginaw Keyway, 289-302; Mid-Mount	30075	<b>M</b> \$639.95
PS & ALT Saginaw Keyway, 351W; Mid-Mount	30095	<b>M</b> \$669.95
ALTERNATOR ONLY 289-302; Mid-Mount	30070	<b>M</b> \$349.95
ALTERNATOR ONLY 351W; Mid-Mount	30090	<b>M</b> \$379.95
ALTERNATOR ONLY 289-302; High-Mount	30065	<b>M</b> \$329.95
ALTERNATOR ONLY 351W; High-Mount	30060	<b>M</b> \$359.95



**EXCEPTIONALLY STYLED  
AIR CLEANERS. THE  
FINISHING TOUCH TO ALL  
TOP OF THE LINE BUILDS.**

MARCH PERFORMANCE BILLET AIR CLEANERS ARE DESIGNED TO FIT SINGLE FOUR BARREL CAB APPLICATIONS. SEE THE FULL LINEUP ON PAGE 60.





## SERPENTINE PULLEY KITS

PULLEY KIT	WATER PUMP TYPE	PULLEY RATIO	WATER PUMP PULLEY	CRANKSHAFT PULLEY	ALTERNATOR PULLEY	OPTIONAL PS PULLEY
1670 <b>\$239</b>	'85 CROWN VIC	PERFORMANCE	2004 (5.50") <b>\$99</b>	2011 (4.38") <b>\$91</b>	206 (2.38") <b>\$62</b>	
2015 <b>\$239</b>	REVERSE (79-93)	POWER & AMP	2012 (5.50") <b>\$98</b>	2011 (4.38") <b>\$91</b>	112 (1.69") <b>\$64</b>	630 <b>\$93</b>
2010 <b>\$239</b>	REVERSE (79-93)	PERFORMANCE	2012 (5.50") <b>\$98</b>	2011 (4.38") <b>\$91</b>	206 (2.38") <b>\$62</b>	630 <b>\$93</b>
2110 <b>\$235</b>	REVERSE (94-95)	PERFORMANCE	2112 (6.0") <b>\$94</b>	2111 (5.0") <b>\$94</b>	208 (2.75") <b>\$61</b>	632 <b>\$93</b>
1675 <b>\$249</b>	'85 CROWN VIC	HIGHFLOW	2004 (5.50") <b>\$99</b>	2008 (6.12") <b>\$124</b>	206 (2.38") <b>\$62</b>	



6-RIB SERPENTINE



- » March Performance recommends high flow for most applications.
- » Power steering pulleys are not included w/ pulley kits.
- » Pulleys 2012 and 2112 are non-ribbed.
- » Please visit [marchperformance.com](http://marchperformance.com) for additional 1979-93 Fox Body mustang OEM style replacements.

## SMALL BLOCK FORD ACCESSORIES



Small Block Ford early water pump. High flow. Available in as-cast or black.

**P2141**

**\$108.95**



Small Block Ford late water pump. High flow. Available in as-cast or black.

**P2162**

**\$128.95**

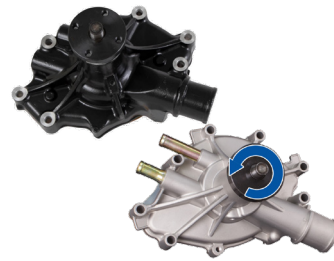

Small Block Ford reverse rotation water pump. Used from 1979-93. High flow. Available in as-cast, black, or chrome.

**P2173**

**\$79.95**

## SMALL BLOCK FORD PULLEY SPACERS



Female and male .9375" spacer. For use w/ late water pump and aftermarket 4 bolt balancer.

**1434**

**\$86.95**



Male and male locators .9375" spacer. For use w/ Ford SVO & Summit balancers.

**1433**

**\$86.95**



.614" spacer for aftermarket 28oz Fluid Damper. Most aftermarket balancers use 1434 (.9375").

**1431**

**\$76.95**



Adapts OEM 3 bolt balancer to a 4 bolt crank pulley. Thickness of .9375"

**1432**

**\$88.95**

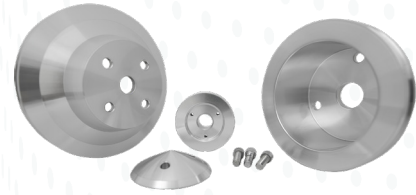

### V-BELT PULLEY KITS - EARLY WATER PUMP (PASSENGER SIDE LOWER RADIATOR HOSE)

PULLEY KIT	BALANCER (OEM)	PULLEY RATIO	WATER PUMP PULLEY			CRANKSHAFT PULLEY			ALTERNATOR PULLEY		PS PULLEY (KEY/PRESS)	
1585	\$298	3BOLT	HIGHFLOW	2V	1563 (5.0")	\$123	3V	1593 (5.50")	\$137	137 (2.69")	\$56	504/502
1565	\$269	3BOLT	HIGHFLOW	2V	1563 (5.0")	\$123	2V	1561 (5.50")	\$115	137 (2.69")	\$56	504/502
1555	\$258	3BOLT	HIGHFLOW	1V	1553 (5.0")	\$115	1V	1561 (5.50")	\$115	137 (2.69")	\$56	
1595	\$289	3BOLT	PERFORMANCE	2V	1562 (6.0")	\$128	3V	1593 (5.50")	\$137	137 (2.69")	\$56	504/502
1560	\$269	3BOLT	PERFORMANCE	2V	1562 (6.0")	\$128	2V	1561 (5.50")	\$115	137 (2.69")	\$56	504/502
1550	\$249	3BOLT	PERFORMANCE	1V	1552 (6.0")	\$111	1V	1551 (5.50")	\$104	137 (2.69")	\$56	
1697	\$298	4BOLT	HIGHFLOW	2V	1563 (5.0")	\$123	3V	1547 (5.75")	\$129	137 (2.69")	\$56	504/502
1637	\$279	4BOLT	HIGHFLOW	2V	1563 (5.0")	\$123	2V	1545 (5.50")	\$123	137 (2.69")	\$56	504/502
1617	\$252	4BOLT	HIGHFLOW	1V	1553 (5.0")	\$115	1V	1614 (5.50")	\$98	137 (2.69")	\$56	
1695	\$298	4BOLT	PERFORMANCE	2V	1562 (6.0")	\$128	3V	1547 (5.75")	\$129	137 (2.69")	\$56	504/502
1635	\$285	4BOLT	PERFORMANCE	2V	1562 (6.0")	\$128	2V	1545 (5.50")	\$115	137 (2.69")	\$56	504/502
1615	\$259	4BOLT	PERFORMANCE	1V	1552 (6.0")	\$111	1V	1614 (5.50")	\$98	137 (2.69")	\$56	

» March Performance recommends high flow for most applications.  
 » Power steering pulleys are not included w/ pulley kits.

### V-BELT PULLEY KITS - LATE WATER PUMP (DRIVER'S SIDE LOWER RADIATOR HOSE)

PULLEY KIT	BALANCER (OEM)	PULLEY RATIO	WATER PUMP PULLEY			CRANKSHAFT PULLEY			ALTERNATOR PULLEY		PS PULLEY (KEY/PRESS)	
1685	\$287	4BOLT	HIGHFLOW	1V	1618 (5.25")	\$111	3V	1691 (5.75")	\$137	137 (2.69")	\$56	504/502
1655	\$289	4BOLT	HIGHFLOW	1V	1618 (5.25")	\$111	3V	1651 (5.50")	\$127	137 (2.69")	\$56	504/502
1667	\$284	4BOLT	HIGHFLOW	2V	1633 (5.25")	\$136	2V	1631 (5.50")	\$100	137 (2.69")	\$56	504/502
1657	\$264	4BOLT	HIGHFLOW	1V	1618 (5.25")	\$111	2V	1631 (5.50")	\$100	137 (2.69")	\$56	504/502
1647	\$271	4BOLT	HIGHFLOW	1V	1616 (5.25")	\$139	1V	1611 (5.50")	\$98	137 (2.69")	\$56	
1645	\$259	4BOLT	HIGHFLOW	1V	1618 (5.25")	\$111	1V	1614 (5.50")	\$98	137 (2.69")	\$56	
1690	\$289	4BOLT	PERFORMANCE	1V	1612 (6.25")	\$116	3V	1691 (5.75")	\$137	137 (2.69")	\$56	504/502
1650	\$289	4BOLT	PERFORMANCE	1V	1612 (6.25")	\$116	3V	1651 (5.50")	\$127	137 (2.69")	\$56	504/502
1630	\$262	4BOLT	PERFORMANCE	2V	1632 (6.25")	\$127	2V	1631 (5.50")	\$100	137 (2.69")	\$56	504/502
1625	\$238	4BOLT	PERFORMANCE	1V	1612 (6.25")	\$116	2V	1631 (5.50")	\$100	137 (2.69")	\$56	504/502
1610	\$235	4BOLT	PERFORMANCE	1V	1613 (6.25")	\$111	1V	1611 (5.50")	\$98	137 (2.69")	\$56	
1640	\$252	4BOLT	PERFORMANCE	1V	1612 (6.25")	\$116	1V	1614 (5.50")	\$98	137 (2.69")	\$56	

» March Performance recommends high flow for most applications.  
 » Power steering pulleys are not included w/ pulley kits.

ALT. BRACKETS	KIT CODE	
<b>ULTRA SERIES</b> Mid-mount, late wp, 289-302	30355	<b>M</b> \$129. <sup>95</sup>
<b>ULTRA SERIES</b> Mid-mount, early wp, 289-302	30351-08	<b>M</b> \$134. <sup>95</sup>
<b>ULTRA SERIES</b> Mid-mount, late wp, 351W	30395	<b>M</b> \$134. <sup>95</sup>
<b>ULTRA SERIES</b> Mid-mount, early wp, 351W	30391-08	<b>M</b> \$139. <sup>95</sup>
<b>ULTRA SERIES</b> High-mount, counter clockwise wp, 289-302	30028	<b>M</b> \$142. <sup>95</sup>
<b>DELUXE SERIES</b> Adjustable, counter clockwise, 289-302	1465-09	<b>M</b> \$69. <sup>95</sup>
<b>DELUXE SERIES</b> High-mount, counter clockwise, 289-302	30025	<b>M</b> \$122. <sup>95</sup>
<b>DELUXE SERIES</b> High-mount, counter clockwise, 351W	30055	<b>M</b> \$159. <sup>95</sup>



## ALTERNATOR BRACKETS



PS. BRACKETS	KIT CODE	
<b>ULTRA SERIES</b> Mid-mount, Saginaw, ccw wp, 289-302-351W	30037	<b>M</b> \$147. <sup>95</sup>
<b>ULTRA SERIES</b> Mid-mount, plastic res, ccw wp, 289-302-351W	30038-08	<b>M</b> \$147. <sup>95</sup>
<b>ULTRA SERIES</b> Mid-mount, Saginaw, late wp, 302, includes PS pulley	30356	<b>M</b> \$221. <sup>95</sup>
<b>DELUXE SERIES</b> Mid-mount, plastic res, ccw wp, 289-302-351W	30035-08	<b>M</b> \$130. <sup>95</sup>
<b>ULTRA SERIES</b> Mid-mount, Saginaw, early wp, 289-302	30352	<b>M</b> \$124. <sup>95</sup>
<b>DELUXE SERIES</b> idler bracket, ccw wp, 289-302-351W	30040-08	<b>M</b> \$161. <sup>95</sup>
<b>ULTRA SERIES</b> Mid-mount, Saginaw, early wp, 351W	30392	<b>M</b> \$139. <sup>95</sup>
<b>DELUXE SERIES</b> Mid-mount, Saginaw, late wp, 351W, includes PS pulley	30396	<b>M</b> \$234. <sup>95</sup>

» CCW WP is a counter clockwise water pump starting in the 80's.  
 » 30037 & 30038 allow use of mechanical fuel pump. All other brackets require electric fuel pump.



## POWER STEERING BRACKETS



**QUESTIONS?**  
 CONTACT OUR WORLD CLASS SUPPORT TEAM  
**(888) 729-9070**



## EVOLUTION

### ALL INCLUSIVE MID-MOUNT EVOLUTION SERIES



SKU  
351C-EV-ACO-88



SKU  
351C-EV-AC

#### KIT DETAILS

» Price includes water pump, timing cover, alternator, power steering pump, brackets, pulleys, hub adapter, remote reservoir and belt.

APPLICATION	KIT CODE
AC, PS & ALT GM Type II Pump w/ Remote Reservoir	351C-EV-AC <b>M</b> \$2995.00
PS & ALT GM Type II Pump w/ Remote Reservoir	351C-EV-PS <b>M</b> \$2895.00
AC & ALT	351C-EV-ACO <b>M</b> \$2895.00
ALTERNATOR ONLY	351C-EV-ALT <b>M</b> \$2795.00

PATENT  
PENDING

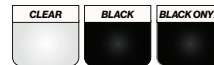

## Style TRACK

### ALL INCLUSIVE MID-MOUNT STYLE TRACK

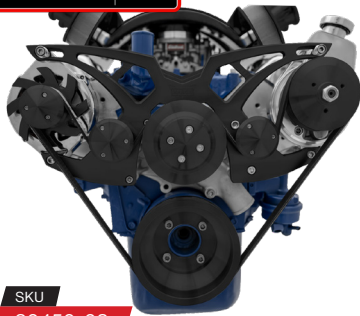

SKU  
30450-08

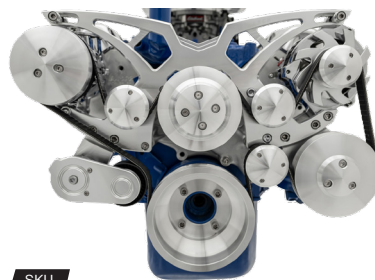

SKU  
30440

#### KIT DETAILS

» Price includes, water pump, alternator, power steering pump, AC compressor brackets, pulleys and hardware. Remote reservoir and belt not included.  
 » Requires 4 bolt factory balancer.  
 » Compatible with 351C, 351M and 400 engines.

APPLICATION	KIT CODE
AC, PS & ALT GM Type II Pump w/ Remote Reservoir	30440 <b>M</b> \$1995.95
AC & ALT	30430 <b>M</b> \$1895.95
PS & ALT Saginaw Keyway, Billet Accessories	30460 <b>M</b> \$2194.95
PS & ALT Saginaw Keyway, Chrome Accessories	30450 <b>M</b> \$1895.95

#### Optional Add-on Accessories:

» March Performance stocks a full line of premium 6 and 8 rib belts.



# M

PERFORMANCE

---

BILLET SHIFTERS & KNOBS



» See more on page 65.

APPLICATION	KIT CODE	
<b>AC, PS &amp; ALT</b> 289-302, Saginaw Keyway	30445	<b>M</b> \$999. <sup>95</sup>
<b>PS &amp; ALT</b> 351C, Saginaw Keyway	30435	<b>M</b> \$699. <sup>95</sup>
<b>ALTERNATOR ONLY</b>	30425	<b>M</b> \$499. <sup>95</sup>

## ULTRA SERIES MID-MOUNT SERPENTINE CONVERSION

**ULTRA**

### Optional Add-on Accessories:

» Fuelie billet air cleaner w/ our Black Onyx finish.



SKU  
9755-07

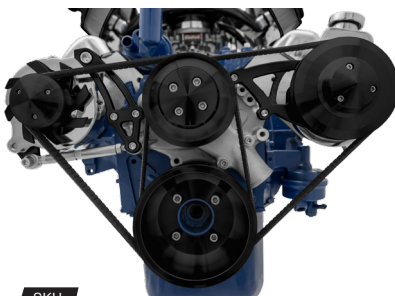

SKU  
30435-08

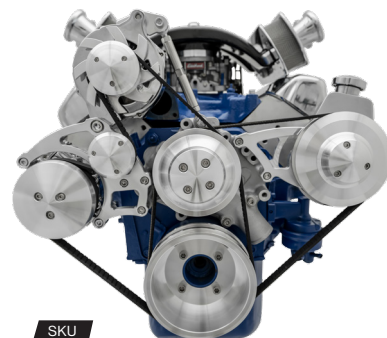

SKU  
30445

### KIT DETAILS

- » Prices include all brackets, pulleys & hardware.
- » AC applications require Sanden style 7176 compressors (March #P2412)
- » Requires 4 bolt factory balancer.
- » For full details and customization options visit [www.marchperformance.com](http://www.marchperformance.com).



DESCRIPTION	KIT CODE	
<b>ALTERNATOR MOUNT</b> Mid-mount, passenger side, clear or black	30400	<b>M</b> \$147. <sup>95</sup>
<b>PS BRACKET</b> Mid-mount, passenger side, clear or black	30405	<b>M</b> \$146. <sup>95</sup>
<b>WATER PUMP</b> High flow, aluminum, clear or black	P2164	<b>M</b> \$128. <sup>95</sup>

- » Alternator only applications use pulley kits 1610 or 1647.
- » Alternator and power steering applications use pulley kits 1625 (performance ratio) or 1657 (high flow).
- » For power steering applications use pulley 510 for keyway applications or 511 for press fit.



## INDIVIDUAL FORD 351C PRODUCTS

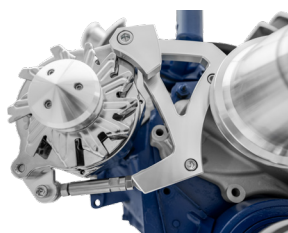

SKU  
30400

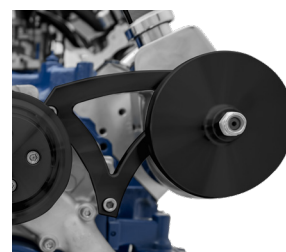

SKU  
30405-08



SKU  
P2164

## FAST AND FREE SHIPPING



- » Free shipping on any order over \$199. All other orders ship for a flat rate of \$9.99.
- » All March products are designed, machined, and stocked in our state of the art facility in the USA. This allows us to ship most orders within 24 hours.
- » Near or far, March has you covered. We use multiple shipping carriers to ship all over the world.

## Style TRACK

### ALL INCLUSIVE MID-MOUNT STYLE TRACK

APPLICATION	KIT CODE		
AC, PS & ALT GM Type II Pump w/ Remote Reservoir	30275	<b>M</b>	\$1995. <sup>95</sup>
AC & ALT	30270	<b>M</b>	\$1895. <sup>95</sup>
PS & ALT Saginaw Keyway, Billet Accessories	30285	<b>M</b>	\$2194. <sup>95</sup>
PS & ALT Saginaw Keyway, Chrome Accessories	30280	<b>M</b>	\$1895. <sup>95</sup>



SKU  
30285-07

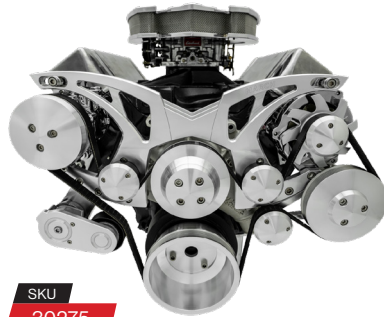

SKU  
30275

#### KIT DETAILS

- » Price includes, water pump, alternator, power steering pump, AC compressor brackets, pulleys and hardware. Remote reservoir and belt not included.
- » Requires 4 bolt factory balancer.



## ULTRA

### ULTRA SERIES SERPENTINE CONVERSION

PS. BRACKETS	KIT CODE		
AC, PS & ALT Saginaw Keyway, 7176 AC	30230	<b>M</b>	\$999. <sup>95</sup>
AC, PS & ALT Saginaw Keyway, 508 AC	30260	<b>M</b>	\$999. <sup>95</sup>
AC, PS & ALT Saginaw Press Fit, 7176 AC	30235	<b>M</b>	\$999. <sup>95</sup>
AC, PS & ALT Saginaw Press Fit, 508 AC	30265	<b>M</b>	\$999. <sup>95</sup>
AC & ALT 508 AC	30255	<b>M</b>	\$699. <sup>95</sup>
PS & ALT Saginaw Keyway	30245	<b>M</b>	\$699. <sup>95</sup>
PS & ALT Saginaw Press Fit	30250	<b>M</b>	\$699. <sup>95</sup>
ALTERNATOR ONLY	30240	<b>M</b>	\$499. <sup>95</sup>



SKU  
30260-08

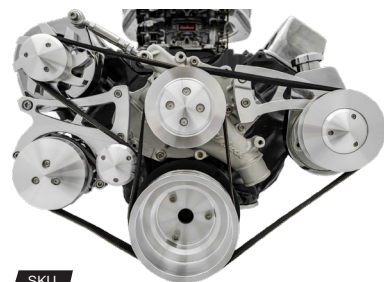

SKU  
30230



SKU  
30240-08

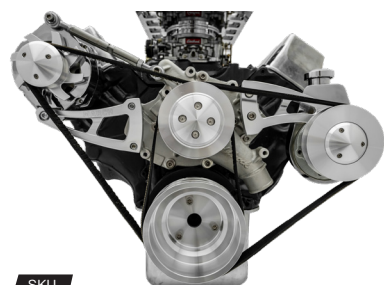

SKU  
30245

#### KIT DETAILS

- » Price includes brackets, pulleys and hardware.
- » Requires 1970+ water pump and timing cover.
- » Requires 4 bolt factory balancer.



### BIG BLOCK FORD WATER PUMPS



High flow aluminum water pump for Big Block Ford engines. 5.5" hub height; 3/4" shaft. As cast finish.

**P2158**

**\$149.<sup>95</sup>**



High flow aluminum water pump for Big Block Ford engines. 5.5" hub height; 3/4" shaft. Black finish.

**P2158-08**

**\$174.<sup>95</sup>**



# FORD BIG BLOCK/MOD MOTORS

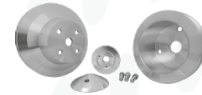

## BIG BLOCK FORD V-BELT PULLEY KITS

PULLEY KIT	PULLEY RATIO	WATER PUMP PULLEY			CRANKSHAFT PULLEY			ALTERNATOR PULLEY			PS PULLEY (PRESS FIT)	
1855 <b>\$293</b>	HIGHFLOW	2V	1833 (5.25")	<b>\$129</b>	3V	1851 (5.75")	<b>\$129</b>	1V	145 (2.69")	<b>\$60</b>	502	<b>\$85</b>
1825 <b>\$273</b>	HIGHFLOW	1V	1813 (5.25")	<b>\$112</b>	2V	1831 (5.75")	<b>\$108</b>	1V	145 (2.69")	<b>\$60</b>	502	<b>\$85</b>
1815 <b>\$249</b>	HIGHFLOW	1V	1813 (5.25")	<b>\$112</b>	1V	1811 (5.75")	<b>\$101</b>	1V	147 (2.69")	<b>\$62</b>		
1850 <b>\$293</b>	PERFORMANCE	2V	1832 (6.25")	<b>\$128</b>	3V	1851 (5.75")	<b>\$129</b>	1V	145 (2.69")	<b>\$60</b>	502	<b>\$85</b>
1830 <b>\$261</b>	PERFORMANCE	1V	1812 (6.0")	<b>\$112</b>	2V	1831 (5.75")	<b>\$108</b>	1V	145 (2.69")	<b>\$60</b>	502	<b>\$85</b>
1810 <b>\$256</b>	PERFORMANCE	1V	1812 (6.0")	<b>\$112</b>	1V	1811 (5.75")	<b>\$101</b>	1V	147 (2.69")	<b>\$62</b>		



- » March Performance recommends high flow for most applications.
- » Power steering pulleys are not included in pulley kits.
- » All kits require 4 bolt factory balancer.

## FORD 3.8L SERPENTINE PULLEYS

APPLICATION	PULLEY KIT	WATER PUMP PULLEY	CRANKSHAFT PULLEY	ALTERNATOR PULLEY
'94-98 Mustangs w/ 3.8L V6 Engine	2170-08 <b>\$134</b>		2171-08 (5.75") <b>\$105</b>	121-08 (2") <b>\$34</b>



## FORD 4.6L MUSTANG SERPENTINE PULLEYS

PULLEY KIT	GT YEARS	COBRA YEARS	WATER PUMP TYPE	WATER PUMP PULLEY	CRANKSHAFT PULLEY	ALTERNATOR PULLEY	BALANCER
1175-08 <b>\$249</b>	1996-2004	1996-1999	LONG	1152-08 (6.5") <b>\$89</b>		113-08 (2.5") <b>\$29</b>	P1158-08 <b>\$136</b>
1170-08 <b>\$199</b>	2001-2004	2001	SHORT	1172-08 (6.5") <b>\$89</b>	1156-08 (5.25") <b>\$99</b>	113-08 (2.5") <b>\$29</b>	
1150-08 <b>\$199</b>	1996-1998	1996-1999	LONG	1152-08 (6.5") <b>\$89</b>	1151-08 (5.25") <b>\$99</b>	113-08 (2.5") <b>\$29</b>	
1155-08 <b>\$199</b>	1999-2004		LONG	1152-08 (6.5") <b>\$89</b>	1156-08 (5.25") <b>\$99</b>	113-08 (2.5") <b>\$29</b>	
1180-08 <b>\$249</b>	2001-2004	2001	SHORT	1172-08 (6.5") <b>\$89</b>		113-08 (2.5") <b>\$29</b>	P1158-08 <b>\$136</b>

» Short water pump pulley is 1.375" thick, long is 1.875".



## FORD 4.6L MUSTANG SERPENTINE PULLEYS

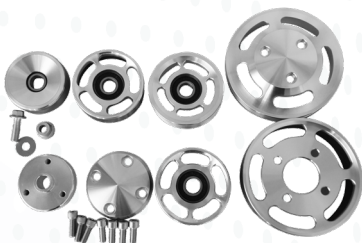

- » Compatible with 2005 - 2009 Ford 4.6 Mustang GT
- » Includes water pump pulley w/ cover (1201), Power Steering Pulley (660), Power Steering Hub Adapter (P602), 1 ribbed Idler Pulley (765), 2 non-ribbed idler pulleys (760) and Belt Tensioner pulley (711).



**M** 1200

**M** \$662.95



## ALL INCLUSIVE MID-MOUNT PRO-TRACK

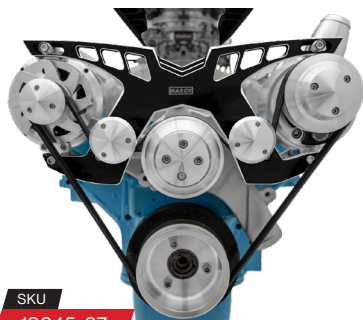

SKU  
19045-07

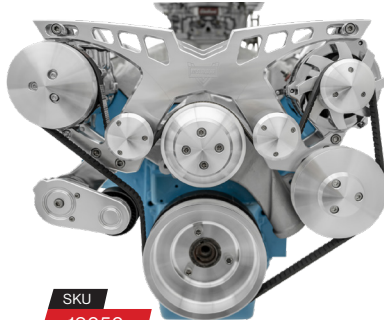

SKU  
19050

### KIT DETAILS

- » Price includes, water pump, alternator, power steering pump, AC compressor brackets, pulleys and hardware. Remote reservoir and belt not included.
- » Requires 3 bolt balancer without casted V-Groove.

### APPLICATION

### KIT CODE

<b>AC, PS &amp; ALT</b> GM Type II Pump w/ Remote Reservoir	19050	<b>M</b> \$2199. <sup>95</sup>
<b>AC &amp; ALT</b>	19055	<b>M</b> \$2099. <sup>95</sup>
<b>PS &amp; ALT</b> Saginaw Keyway, Billet Accessories	19045	<b>M</b> \$2398. <sup>95</sup>
<b>PS &amp; ALT</b> Saginaw Keyway, Chrome Accessories	19040	<b>M</b> \$2099. <sup>95</sup>



**QUESTIONS?**  
CONTACT OUR WORLD CLASS SUPPORT TEAM  
**(888) 729-9070**



## ULTRA SERIES SERPENTINE CONVERSION

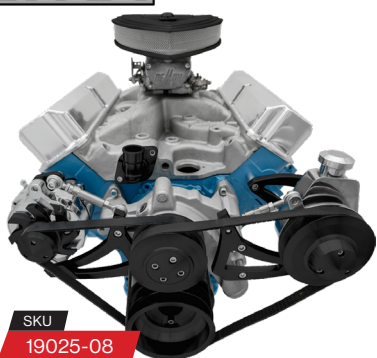

SKU  
19025-08

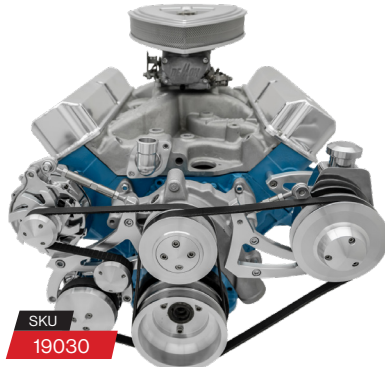

SKU  
19030

### KIT DETAILS

- » Price includes brackets, pulleys and hardware. Accessories and belt not included.
- » Requires 3 bolt balancer without casted V-Groove.

### APPLICATION

### KIT CODE

<b>AC, PS &amp; ALT</b> Saginaw Keyway, 7176 AC	19030	<b>M</b> \$869. <sup>95</sup>
<b>AC &amp; ALT</b>	19035	<b>M</b> \$819. <sup>95</sup>
<b>PS &amp; ALT</b> Saginaw Keyway	19025	<b>M</b> \$699. <sup>95</sup>
<b>ALTERNATOR ONLY</b>	19020	<b>M</b> \$499. <sup>95</sup>



## FORD FE V-BELT PULLEY KITS

PULLEY KIT		PULLEY RATIO	WATER PUMP PULLEY			CRANKSHAFT PULLEY		ALTERNATOR PULLEY			
1945	\$281	HIGHFLOW	2V	1562 (6.0")	\$128	3V	1951 (5.50")	\$116	1V	137 (2.69")	\$56
1925	\$268	HIGHFLOW	2V	1562 (6.0")	\$128	2V	1931 (5.50")	\$114	1V	137 (2.69")	\$56
1905	\$231	HIGHFLOW	1V	1552 (6.0")	\$111	1V	1911 (5.50")	\$79	1V	137 (2.69")	\$56
1950	\$281	PERFORMANCE	2V	1932 (6.75")	\$137	3V	1951 (5.50")	\$116	1V	137 (2.69")	\$56
1930	\$273	PERFORMANCE	2V	1932 (6.75")	\$137	2V	1931 (5.50")	\$114	1V	137 (2.69")	\$56
1910	\$238	PERFORMANCE	1V	1912 (6.75")	\$107	1V	1911 (5.50")	\$79	1V	137 (2.69")	\$56

# FORD FLATHEAD & COYOTE

APPLICATION	KIT CODE		
AC, PS & ALT GM Type II Remote PS, 45° Motor Mounts	30615	<b>M</b>	\$2399. <sup>95</sup>
AC, PS & ALT GM Type II Remote PS, 90° Motor Mounts	30600	<b>M</b>	\$2399. <sup>95</sup>
AC & ALT 45° Motor Mounts	30620	<b>M</b>	\$2299. <sup>95</sup>
AC & ALT 90° Motor Mounts	30610	<b>M</b>	\$2299. <sup>95</sup>

## ALL INCLUSIVE STYLE TRACK SERPENTINE SYSTEM

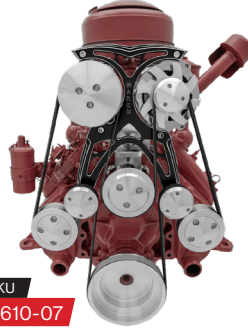

SKU  
30610-07

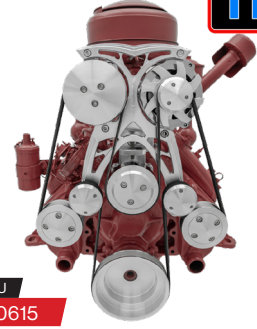

SKU  
30615

### KIT DETAILS

- » Price includes ac compressor, 2 water pumps, power steering pump, alternator, pulleys, brackets & hardware.
- » Power steering remote reservoir and belt sold separately.
- » Compatible with 1949-1953 Ford Flathead engine with 45° or 90° mounts.



APPLICATION	KIT CODE		
AC, PS & ALT 3 Bolt Water Pump, No Supercharger	30555	<b>M</b>	\$1699. <sup>95</sup>
AC, PS & ALT 4 Bolt Water Pump, No Supercharger	30550	<b>M</b>	\$1699. <sup>95</sup>
AC, PS & ALT 3 Bolt Water Pump, Edelbrock™ Supercharger	30585	<b>M</b>	\$1849. <sup>95</sup>
AC, PS & ALT 4 Bolt Water Pump, Edelbrock™ Supercharger	30580	<b>M</b>	\$1849. <sup>95</sup>
PS & ALT 3 Bolt Water Pump, No Supercharger	30525	<b>M</b>	\$1599. <sup>95</sup>
PS & ALT 4 Bolt Water Pump, No Supercharger	30520	<b>M</b>	\$1599. <sup>95</sup>
PS & ALT 3 Bolt Water Pump, Edelbrock™ Supercharger	30575	<b>M</b>	\$1749. <sup>95</sup>
PS & ALT 4 Bolt Water Pump, Edelbrock™ Supercharger	30570	<b>M</b>	\$1749. <sup>95</sup>
ALTERNATOR ONLY 3 Bolt Water Pump, No Supercharger	30515	<b>M</b>	\$899. <sup>95</sup>
ALTERNATOR ONLY 4 Bolt Water Pump, No Supercharger	30510	<b>M</b>	\$899. <sup>95</sup>

## ULTRA SERIES SERPENTINE SYSTEM



SKU  
30555-08



SKU  
30555



SKU  
30525-08



SKU  
30580

### KIT DETAILS

- » Price includes AC compressor, power steering pump, alternator, brackets, pulleys & hardware.
- » Does not include water pump or supercharger.
- » Supercharged Edelbrock™ systems use #15885.
- » AC applications use 7176 peanut style compressor and GM Type Pump with remote reservoir (not included).



# CHRYSLER ENGINES

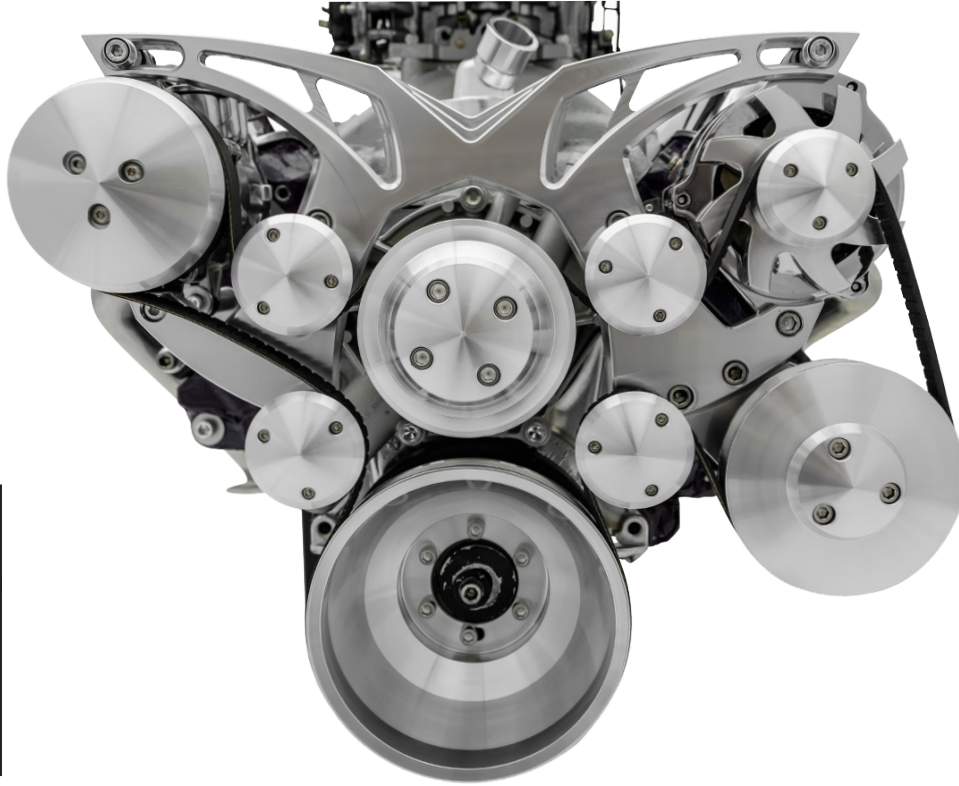

SCAN THE CODE BELOW FOR CHRYSLER KIT DETAILS, PRICING & AVAILABILITY



## KITS, FINISH TYPES, & PRICING FOR CHRYSLER KITS



## KEY FEATURES, DETAILS & TECHNICAL SPECIFICATIONS

### FEATURES

**KIT TYPES:** March offers serpentine, v-belt, and individual pulley & bracket kits.  
**ULTRA ACCESSORIES:** In addition, all kits have options for our March Ultra series accessories, including alternators, power steering pumps, water pumps & AC compressors.  
**LIFE TIME WARRANTY:** All March pulleys, brackets, engine accessories include an industry leading Lifetime Warranty.

### TECHNICAL DETAILS

**DIMENSIONS & COMPATIBILITY:** Visit [marchperformance.com](http://marchperformance.com) for full details.  
**TECH SUPPORT:** All March products include free support for the life time of the product. Call 1.888.729.9070 or email [info@marchperformance.com](mailto:info@marchperformance.com).

PG	ENGINE TYPE
45	SMALL BLOCK
49	BIG BLOCK
50	GEN III HEMI
50	392 HEMI
51	MAGNUM
51	SRT10/VIPER

# CHRYSLER SMALL BLOCK

APPLICATION	KIT CODE
AC, PS & ALT GM Type II Pump w/ Remote Reservoir	40440 <b>M</b> \$2195.95
AC & ALT Timing Cover Included	40430 <b>M</b> \$2095.95

## ALL INCLUSIVE STYLE TRACK SERPENTINE SYSTEM

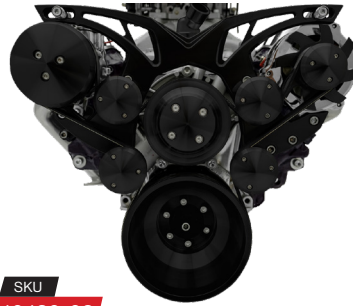

SKU  
40430-08

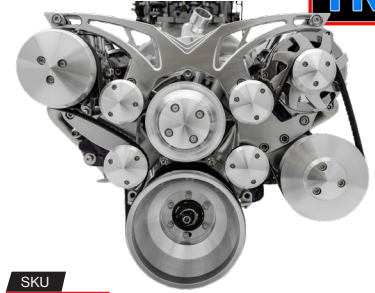

SKU  
40440

### Optional Add-on Accessories:

» Remote power steering reservoir.



SKU  
450



### KIT DETAILS

- » Price includes new water pump, alternator, peanut style AC compressor, power steering pump, brackets, pulleys and hardware. Remote reservoir and belt sold separately.
- » Requires 4.5" from balancer face to water pump flange.

APPLICATION	KIT CODE
PS & ALT Saginaw keyway, billet accessories	40455 <b>M</b> \$2394.95
PS & ALT Saginaw keyway, chrome accessories	40450 <b>M</b> \$2095.95

## ALL INCLUSIVE MID-MOUNT PRO-TRACK



SKU  
40450-07



SKU  
40455

### Optional Add-on Accessories:

» March Performance stocks a full line of premium six rib serpentine belts.



### KIT DETAILS

- » Price includes new water pump, alternator, power steering pump, brackets, pulleys and hardware.
- » Requires 4.5" from balancer face to water pump flange.

APPLICATION	KIT CODE
AC, PS & ALT GM Type II Pump w/ Remote Reservoir	40465 <b>M</b> \$2195.95
AC & ALT	40460 <b>M</b> \$2095.95

## MID-MOUNT | REVERSE ROTATION SHORT WATER PUMP



SKU  
40460-07

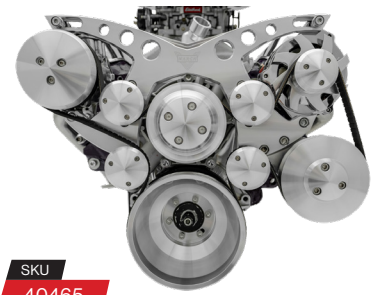

SKU  
40465

### Optional Add-on Accessories:

» Billet trunk hinges for Plymouth Cudas from 1970-1974.



SKU  
TH74C



### KIT DETAILS

- » Price includes new water pump, alternator, peanut style AC compressor, power steering pump, brackets, pulleys and hardware. Remote reservoir not included.
- » Requires 4.5" from balancer face to water pump flange.

# CHRYSLER SMALL BLOCK

## ULTRA

### ULTRA SERIES SERPENTINE CONVERSION

#### APPLICATION

#### KIT CODE

PS & ALT  
Saginaw Pump w/ Keyway

40490 **M** \$885.95

#### Optional Add-on Accessories:

» Saginaw power steering pump w/ keyway shaft.

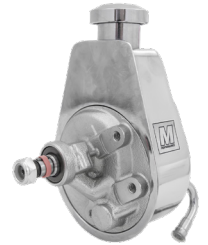

SKU  
P2304

SKU  
40490-08



SKU  
40490



#### KIT DETAILS

- » Price includes all brackets, pulleys & hardware.
- » Requires Sanden Style 7176 AC compressor (March #P2412).
- » Requires Saginaw power steering pump w/ keyway shaft (March #P2304).



## DELUXE

### DELUXE SERIES SERPENTINE CONVERSIONS

#### APPLICATION

#### KIT CODE

AC, PS & ALT  
Saginaw Keyway, 508 AC

40415 **M** \$899.95

AC, PS & ALT  
Saginaw Press Fit, 508 AC

40420 **M** \$899.95

AC & ALT  
508 AC

40425 **M** \$849.95

PS & ALT  
Saginaw Keyway

40405 **M** \$679.95

PS & ALT  
Saginaw Press Fit

40410 **M** \$679.95

ALTERNATOR ONLY

40400 **M** \$429.95



SKU  
40425-08

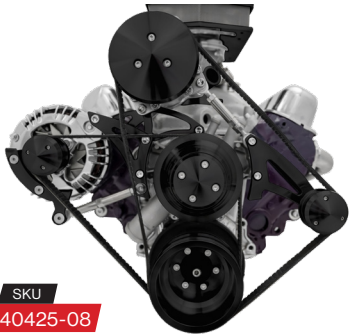

SKU  
40415



SKU  
40400-08

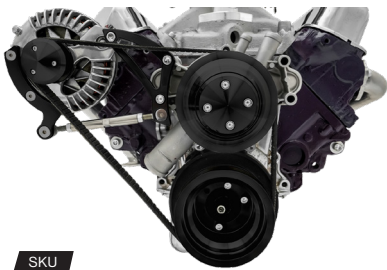

SKU  
40405

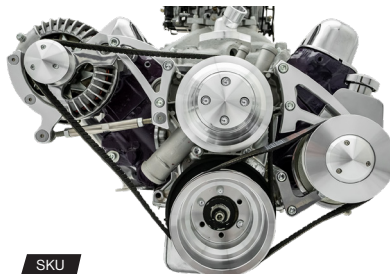

#### KIT DETAILS

- » Prices include all brackets and pulleys.
- » Not compatible w/ March billet power steering pumps.
- » Utilizes Sanden style 508 AC compressor (March #P2413).
- » Requires 4.5" from balancer face to water pump flange.

### SMALL BLOCK CHRYSLER BRACKETS

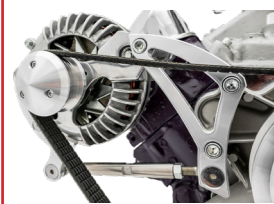

Mounts Chrysler alternator below the valve covers on the US passenger side. Available in clear or black.

**40051** \$129.95

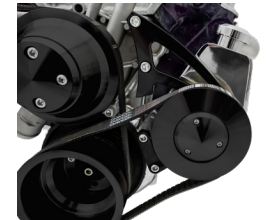

Mounts Saginaw power steering on the driver's side. Available in clear or black.

**40061** \$148.95

# CHRYSLER SMALL & BLOCK



## V-BELT PULLEY KITS: 318 - 340 - 360

PULLEY KIT	PULLEY RATIO	WATER PUMP PULLEY (1V)	CRANKSHAFT PULLEY	ALTERNATOR PULLEY (1V)	OPTIONAL PS PULLEY (SAGINAW KEYWAY   PRESS FIT   FEDERAL)
10255 <b>\$299</b>	PERFORMANCE	10012 (6.75") <b>\$121</b>	2V 10093 (5.5") <b>\$122</b>	139 (2.75") <b>\$61</b>	530 <b>\$85</b> 531 <b>\$85</b> 532 <b>\$99</b>
10215 <b>\$282</b>	PERFORMANCE	10012 (6.75") <b>\$121</b>	1V 10091 (5.5") <b>\$117</b>	139 (2.75") <b>\$61</b>	
10370* <b>\$269</b>	PERFORMANCE	10212 (6.5") <b>\$116</b>	2V 10171 (5.25") <b>\$113</b>	139 (2.75") <b>\$61</b>	530 <b>\$85</b> 531 <b>\$85</b> 532 <b>\$99</b>
10350* <b>\$275</b>	PERFORMANCE	10212 (6.5") <b>\$116</b>	1V 10151 (5.25") <b>\$111</b>	139 (2.75") <b>\$61</b>	
10270 <b>\$282</b>	HIGHFLOW	10252 (6.5") <b>\$113</b>	3V 10271 (6.75") <b>\$120</b>	178 (2V)(2.75") <b>\$64</b>	530 <b>\$85</b> 531 <b>\$85</b> 532 <b>\$99</b>
10265 <b>\$290</b>	HIGHFLOW	10212 (6.5") <b>\$116</b>	2V 10049 (6.5") <b>\$119</b>	139 (2.75") <b>\$61</b>	530 <b>\$85</b> 531 <b>\$85</b> 532 <b>\$99</b>
10225 <b>\$263</b>	HIGHFLOW	10212 (6.5") <b>\$116</b>	1V 10009 (6.5") <b>\$117</b>	139 (2.75") <b>\$61</b>	
10250 <b>\$267</b>	PERFORMANCE	10212 (6.5") <b>\$116</b>	2V 10051 (5.25") <b>\$107</b>	139 (2.75") <b>\$61</b>	530 <b>\$85</b> 531 <b>\$85</b> 532 <b>\$99</b>
10210 <b>\$262</b>	PERFORMANCE	10212 (6.5") <b>\$116</b>	1V 10011 (5.25") <b>\$99</b>	139 (2.75") <b>\$61</b>	

## SERPENTINE PULLEY KITS

» March Performance recommends high flow for most applications

10325* <b>\$264</b>	HIGHFLOW	10302 (5.75") <b>\$110</b>	2V 10307 (6.0") <b>\$122</b>	215 (2.75") <b>\$66</b>	533 <b>\$124</b> 534 <b>\$113</b>
10320* <b>\$257</b>	HIGHFLOW	10302 (5.75") <b>\$110</b>	1V 10303 (6.0") <b>\$112</b>	215 (2.75") <b>\$66</b>	
10305 <b>\$278</b>	HIGHFLOW	10302 (5.75") <b>\$110</b>	2V 10306 (5.75") <b>\$110</b>	215 (2.75") <b>\$66</b>	533 <b>\$124</b> 534 <b>\$113</b>
10300 <b>\$269</b>	HIGHFLOW	10302 (5.75") <b>\$110</b>	1V 10301 (5.75") <b>\$100</b>	215 (2.75") <b>\$66</b>	

» \*Pulley kit is designed for use with Fluid Dampeners (3.75" face to WP flange). Stock is 4.50".

» Kits 10255 & 10215 are for use with 1967 - 1969 Small Block 273, 318 and 340 engines.



## BIG BLOCK V-BELT PULLEY KITS: 383 - 440

PULLEY KIT	PULLEY RATIO	WATER PUMP PULLEY	CRANKSHAFT PULLEY	ALTERNATOR PULLEY (1V)	OPTIONAL PS PULLEY (SAGINAW KEYWAY   PRESS FIT   FEDERAL)
10170* <b>\$269</b>	PERFORMANCE	1V 10052 (6.75") <b>\$132</b>	2V 10171 (5.25") <b>\$113</b>	139 (2.75") <b>\$61</b>	530 <b>\$85</b> 531 <b>\$85</b> 532 <b>\$85</b>
10150* <b>\$257</b>	PERFORMANCE	1V 10012 (6.75") <b>\$121</b>	1V 10151 (5.25") <b>\$111</b>	139 (2.75") <b>\$61</b>	
10070 <b>\$264</b>	HIGHFLOW	1V 10072 (6.75") <b>\$116</b>	4V 10071 (6.25") <b>\$125</b>	178 (2V)(2.75") <b>\$64</b>	530 <b>\$85</b> 531 <b>\$85</b> 532 <b>\$85</b>
10075 <b>\$279</b>	HIGHFLOW	2V 10052 (6.75") <b>\$116</b>	2V 10049 (6.5") <b>\$119</b>	139 (2.75") <b>\$61</b>	530 <b>\$85</b> 531 <b>\$85</b> 532 <b>\$85</b>
10015 <b>\$276</b>	HIGHFLOW	1V 10012 (6.75") <b>\$121</b>	1V 10009 (6.5") <b>\$117</b>	139 (2.75") <b>\$64</b>	
10050 <b>\$263</b>	PERFORMANCE	2V 10052 (6.75") <b>\$116</b>	2V 10051 (5.25") <b>\$107</b>	139 (2.75") <b>\$61</b>	530 <b>\$85</b> 531 <b>\$85</b> 532 <b>\$85</b>
10010 <b>\$262</b>	PERFORMANCE	1V 10012 (6.75") <b>\$121</b>	1V 10011 (5.25") <b>\$99</b>	139 (2.75") <b>\$61</b>	

## SERPENTINE PULLEY KITS

10335* <b>\$294</b>	HIGHFLOW	10312 (4.88") <b>\$119</b>	2V 10307 (6.0") <b>\$122</b>	214 (2.69") <b>\$64</b>	535 <b>\$112</b> 620 <b>\$124</b>
10330* <b>\$264</b>	HIGHFLOW	10312 (4.88") <b>\$119</b>	1V 10303 (6.0") <b>\$112</b>	214 (2.69") <b>\$64</b>	
10315* <b>\$278</b>	HIGHFLOW	10312 (4.88") <b>\$119</b>	2V 10306 (5.75") <b>\$110</b>	214 (2.69") <b>\$64</b>	535 <b>\$112</b> 620 <b>\$124</b>
10310 <b>\$277</b>	HIGHFLOW	10312 (4.88") <b>\$119</b>	1V 10301 (5.75") <b>\$100</b>	214 (2.69") <b>\$64</b>	

» \*Pulley kit is designed for use with Fluid Dampeners (3.50" dampner face to WP flange).

Stock is 4.25".



# CHRYSLER BIG BLOCK

## Style TRACK

### ALL INCLUSIVE STYLE TRACK SERPENTINE SYSTEMS



SKU  
40735-07

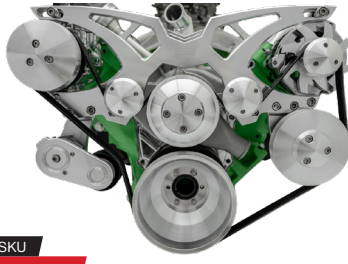

SKU  
40745

#### KIT DETAILS

- » Price includes water pump, AC compressor, power steering pump, alternator, brackets, pulleys and hardware (if applicable). Remote reservoir and belt not included.
- » Requires 4.25" from balancer face to water pump flange.

#### APPLICATION

#### KIT CODE

AC, PS & ALT GM Type II Remote PS	40745	<b>M</b> \$2395. <sup>95</sup>
AC & ALT	40740	<b>M</b> \$2295. <sup>95</sup>
PS & ALT Saginaw Keyway PS, Billet Accessories	40735	<b>M</b> \$2594. <sup>95</sup>
PS & ALT Saginaw Keyway PS, Chrome Accessories	40730	<b>M</b> \$2295. <sup>95</sup>



## Revolver

### ALL INCLUSIVE REVOLVER SERPENTINE SYSTEMS

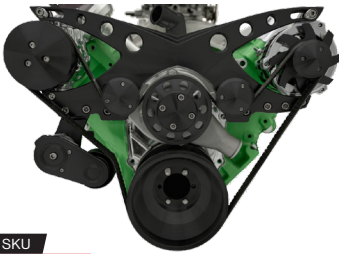

SKU  
40720-08

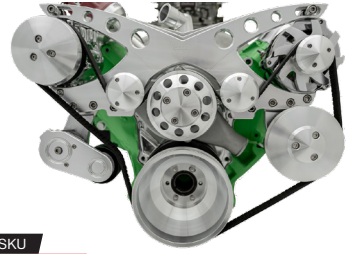

SKU  
40725

#### KIT DETAILS

- » Price includes water pump, AC compressor, power steering pump, alternator, brackets, pulleys and hardware (if applicable). Remote reservoir and belt not included.
- » Requires 4.25" from balancer face to water pump flange.

#### APPLICATION

#### KIT CODE

AC, PS & ALT GM Type II Remote PS	40725	<b>M</b> \$2395. <sup>95</sup>
AC & ALT	40720	<b>M</b> \$2295. <sup>95</sup>

#### Optional Add-on Accessories:

- » Chrome plated Revolver billet air cleaner.



SKU  
9730-06



## ULTRA

### ULTRA SERIES SERPENTINE CONVERSIONS

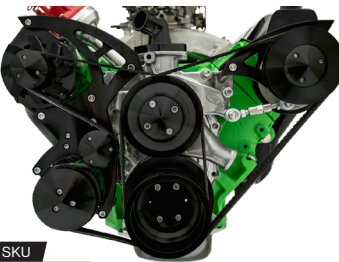

SKU  
40570-08

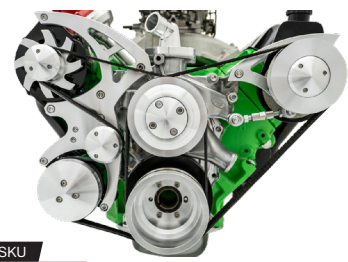

SKU  
40565

#### KIT DETAILS

- » Price includes brackets, pulleys and hardware.
- » Requires 4.25" from balancer face to water pump flange.
- » Requires 10SI alternator, 7176 AC compressor, and Saginaw keyway power steering pump.

#### APPLICATION

#### KIT CODE

AC, PS & ALT 383-400 Engines	40565	<b>M</b> \$999. <sup>95</sup>
AC, PS & ALT 440 Engines	40570	<b>M</b> \$999. <sup>95</sup>

#### Optional Add-on Accessories:

- » Saginaw power steering pump w/ keyway shaft.

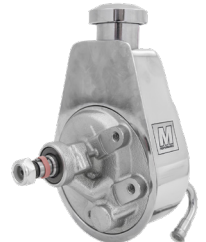

SKU  
P2304





# CHRYSLER BIG BLOCK

APPLICATION	KIT CODE	
AC, PS & ALT Saginaw Keyway, 383-400 Engines	40540	<b>M</b> \$914. <sup>95</sup>
AC, PS & ALT Saginaw Keyway, 440 Engines	40550	<b>M</b> \$914. <sup>95</sup>
AC, PS & ALT Saginaw Press Fit, 383-400 Engines	40545	<b>M</b> \$914. <sup>95</sup>
AC, PS & ALT Saginaw Press Fit, 440 Engines	40560	<b>M</b> \$914. <sup>95</sup>
PS & ALT Saginaw Keyway, 383-400 Engines	40520	<b>M</b> \$653. <sup>95</sup>
PS & ALT Saginaw Keyway, 440 Engines	40525	<b>M</b> \$653. <sup>95</sup>
ALTERNATOR ONLY 383-400 Engines	40510	<b>M</b> \$415. <sup>95</sup>
ALTERNATOR ONLY 440 Engines	40515	<b>M</b> \$415. <sup>95</sup>

## DELUXE SERIES SERPENTINE CONVERSIONS *DELUXE*

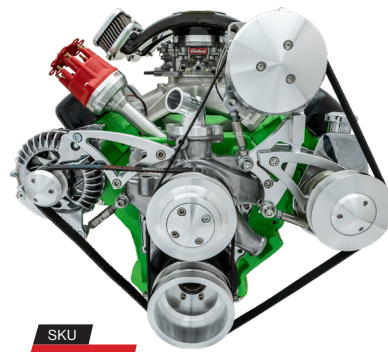
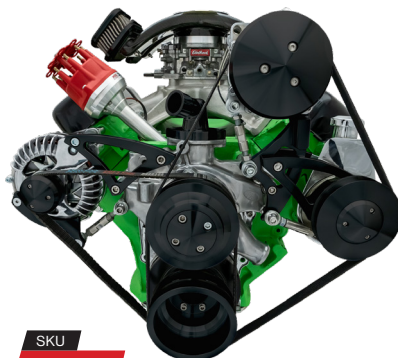

### Optional Add-on Accessories:

» Sanden style 508 AC compressor (6 rib serpentine).

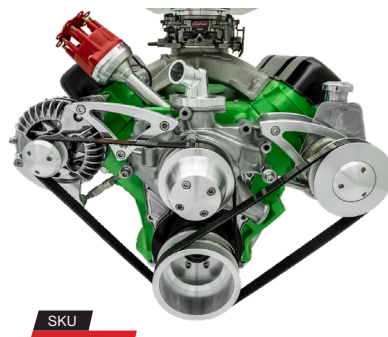

### KIT DETAILS

- » Prices include all brackets and pulleys.
- » AC applications require Sanden style 508 compressor (March #P2413).
- » Requires 4.5" from balancer face to water pump flange.
- » For full details and customization options visit [www.marchperformance.com](http://www.marchperformance.com).

## BIG BLOCK CHRYSLER BRACKETS



Mounts Chrysler alternator below the valve covers on the US passenger side. Available in clear or black. 383-400 engines.

**40020**

\$127.<sup>95</sup>



Mounts Chrysler alternator below the valve covers on the US passenger side. Available in clear or black. 440 engines.

**40010-08**

\$126.<sup>95</sup>



Mounts Saginaw power steering pump on US driver's side in a mid-mount configuration. Available in clear or black.

**40100**

\$139.<sup>95</sup>

## FAST AND FREE SHIPPING



- » Free shipping on any order over \$199. All other orders ship for a flat rate of \$9.99.
- » Near or far, March has you covered. We ship all products worldwide including Vintage Air™ AC systems!

# CHRYSLER 392 | GEN III HEMI



## 392 HEMI (1957-58) SERPENTINE SYSTEMS



SKU  
40765-08



SKU  
40765

### KIT DETAILS

- » Price includes water pump, AC compressor, power steering pump, alternator, brackets, pulleys and hardware.
- » Includes Big Block Chevy water pump & adapter.

### APPLICATION

AC, PS & ALT  
GM Type II Remote PS  
AC & ALT

### KIT CODE

40765 **M** \$2599.<sup>95</sup>  
40760 **M** \$2499.<sup>95</sup>

### Optional Add-on Accessories:

- » Remote power steering reservoir.



SKU  
450



## GEN III HEMI 5.7 - 6.1 - 6.4L



SKU  
40700-07



SKU  
40710

### KIT DETAILS

- » Price includes water pump, AC compressor, power steering pump, alternator, brackets, pulleys and hardware.
- » Requires 2005-2008 timing cover & balancer (300, Charger, Challenger, Magnum).
- » Will not work with VVT (variable valve timing) or EGR.

### APPLICATION

AC, PS & ALT  
GM Type II Remote PS  
AC & ALT

### KIT CODE

40710 **M** \$2399.<sup>95</sup>  
40700 **M** \$2299.<sup>95</sup>

### Optional Add-on Accessories:

- » Universal power steering line kit for remote reservoirs, black braid.



SKU  
PS-LK-REM-08



### ALL NEW WEB EXPERIENCE

- M** Fast lead times.
- M** Complete listing of all product lines.
- M** All finish types in stock.
- M** 100% online direct ordering.
- M** Live chat for sales & tech support.
- M** Streamlined navigation.
- M** Safe & secure checkout.

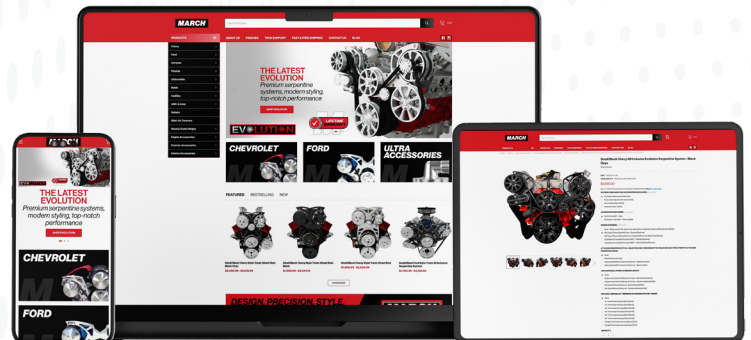

# CHRYSLER MAGNUM & SRT10

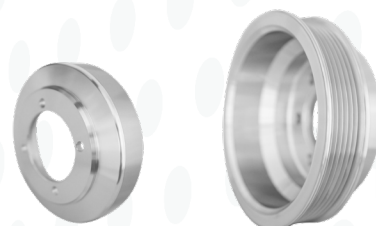

## DODGE MAGNUM 3.9L PULLEY KITS

PULLEY KIT	YEAR RANGE	PULLEY RATIO	WATER PUMP PULLEY	CRANKSHAFT PULLEY	ALTERNATOR PULLEY
10500-08 <b>\$99</b>	1991-2001	PERFORMANCE		10511-08 7Rib,Black <b>\$79</b>	211-08 7Rib,Black <b>\$29</b>
10510 <b>\$262</b>	1991-1997	PERFORMANCE	10512 Smooth, <b>\$103</b>	10511 7Rib <b>\$118</b>	211 7Rib <b>\$71</b>
10515 <b>\$262</b>	1991-1997	POWER & AMP SERIES	10512 Smooth, <b>\$103</b>	10509 6Rib <b>\$129</b>	212 6Rib <b>\$71</b>

## DODGE MAGNUM 5.2L PULLEY KITS

PULLEY KIT	YEAR RANGE	PULLEY RATIO	WATER PUMP PULLEY	CRANKSHAFT PULLEY	ALTERNATOR PULLEY
10500-08 <b>\$99</b>	1991-1999	PERFORMANCE		10511-08 7Rib,Black <b>\$79</b>	211-08 7Rib,Black <b>\$29</b>
10510 <b>\$262</b>	1991-1997	PERFORMANCE	10512 Smooth, <b>\$103</b>	10511 7Rib <b>\$118</b>	211 7Rib <b>\$71</b>
10515 <b>\$262</b>	1991-1997	POWER & AMP SERIES	10512 Smooth, <b>\$103</b>	10509 6Rib <b>\$129</b>	212 6Rib <b>\$71</b>

## DODGE MAGNUM 5.9L PULLEY KITS

PULLEY KIT	YEAR RANGE	PULLEY RATIO	WATER PUMP PULLEY	CRANKSHAFT PULLEY	ALTERNATOR PULLEY
10500-08 <b>\$99</b>	1991-1999	PERFORMANCE		10511-08 7Rib,Black <b>\$79</b>	211-08 7Rib,Black <b>\$29</b>
10510 <b>\$262</b>	1991-1997	PERFORMANCE	10512 Smooth, <b>\$103</b>	10511 7Rib <b>\$118</b>	211 7Rib <b>\$71</b>
10515 <b>\$262</b>	1991-1997	POWER & AMP SERIES	10512 Smooth, <b>\$103</b>	10509 6Rib <b>\$129</b>	212 6Rib <b>\$71</b>

## DODGE VIPER & SRT10 TRUCK PULLEYS

PULLEY KIT	YEARS	CRANKSHAFT PULLEY	WATER PUMP PULLEY	ALTERNATOR PULLEY	IDLER PULLEY	PS PULLEY
10530 <b>\$539</b>	1992-1995	10531 <b>\$124</b>	10532 <b>\$104</b>	216 <b>\$67</b>	712 <b>\$101</b> 736 <b>\$101</b>	539 <b>\$119</b>
10535 <b>\$491</b>	1996-2002	10531 <b>\$124</b>	10532 <b>\$104</b>	216 <b>\$67</b>	712 <b>\$101</b> 736 <b>\$101</b>	538 <b>\$119</b>
10540 <b>\$462</b>	2003-2004	10536 <b>\$125</b>	10537 <b>\$110</b>	213 <b>\$71</b>	711 <b>\$107</b> 736 <b>\$101</b>	545 <b>\$124</b>

## EXCEPTIONALLY STYLED AIR CLEANERS. THE FINISHING TOUCH TO ALL TOP OF THE LINE BUILDS.

MARCH PERFORMANCE BILLET AIR CLEANERS ARE DESIGNED TO FIT SINGLE FOUR BARREL CARB APPLICATIONS. SEE THE FULL LINEUP ON PAGE 60.



SKU  
10535



# MISCELLANEOUS ENGINES

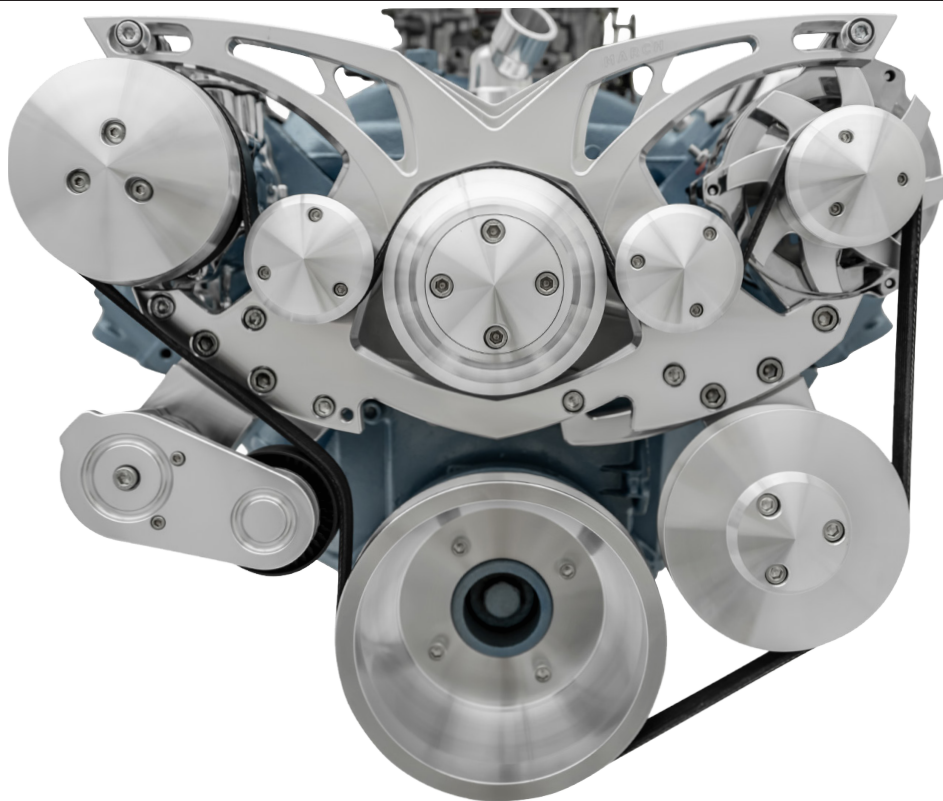

SCAN THE CODE BELOW FOR KIT DETAILS, PRICING & AVAILABILITY



## KITS, FINISH TYPES, & PRICING



## KEY FEATURES, DETAILS & TECHNICAL SPECIFICATIONS

### FEATURES

**KIT TYPES:** March offers serpentine, v-belt, and individual pulley & bracket kits.  
**ULTRA ACCESSORIES:** In addition, all kits have options for our March Ultra series accessories, including alternators, power steering pumps, water pumps & AC compressors.  
**LIFE TIME WARRANTY:** All March pulleys, brackets, engine accessories include an industry leading Lifetime Warranty.

### TECHNICAL DETAILS

**DIMENSIONS & COMPATIBILITY:** Visit [marchperformance.com](http://marchperformance.com) for full details.  
**TECH SUPPORT:** All March products include free support for the life time of the product. Call 1.888.729.9070 or email [info@marchperformance.com](mailto:info@marchperformance.com).

**PG** ENGINE TYPE  
**53** PONTIAC  
**55** CADILLAC  
**55** SUBARU  
**56** OLDSMOBILE  
**57** BUICK  
**59** AMC & JEEP

*Style*  
**TRACK**

APPLICATION	KIT CODE		
AC, PS & ALT GM Type II Remote PS Pump, '67-69 Firebird	13140	<b>M</b>	\$2299.95
AC, PS & ALT GM Type II Remote PS Pump, Standard Chassis	13135	<b>M</b>	\$2299.95
AC & ALT	13130	<b>M</b>	\$2199.95
PS & ALT Saginaw Keyway, Billet Accessories	13150	<b>M</b>	\$2398.95
PS & ALT Saginaw Keyway, Chrome Accessories	13145	<b>M</b>	\$2199.95

## PONTIAC V8 | ALL INCLUSIVE SERPENTINE SYSTEM

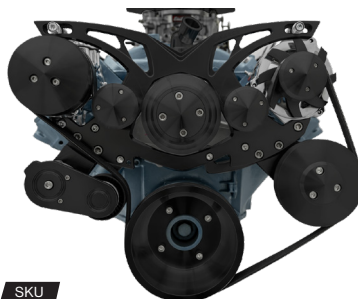

SKU  
13140-08

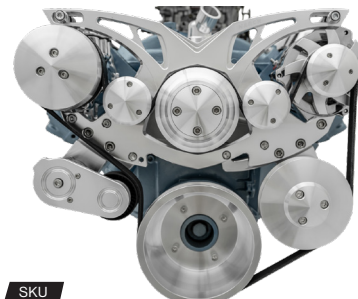

SKU  
13135



### KIT DETAILS

- » Price includes new water pump, alternator, peanut style AC compressor, power steering pump, brackets, pulleys and hardware.
- » Requires 1968+ balancer (4 bolt w/o casted V-Groove) and 1969+ timing cover (11 bolt).
- » Kit 13135 requires electric fuel pump.

APPLICATION	KIT CODE		
AC, PS & ALT GM Type II Remote PS Pump, '67-69 Firebird	13170	<b>M</b>	\$2299.95
AC, PS & ALT GM Type II Remote PS Pump, Standard Chassis	13165	<b>M</b>	\$2299.95
AC & ALT	13160	<b>M</b>	\$2199.95

## PONTIAC V8 | ALL INCLUSIVE SERPENTINE SYSTEM

*Revolver*



SKU  
13160-08

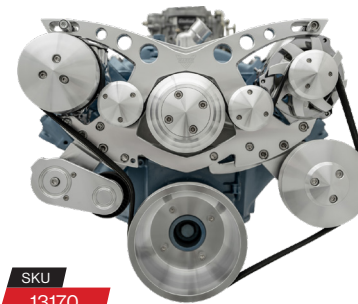

SKU  
13170



### KIT DETAILS

- » Price includes new water pump, alternator, peanut style AC compressor, power steering pump, brackets, pulleys and hardware.
- » Requires 1968+ balancer (4 bolt w/o casted V-Groove) and 1969+ timing cover (11 bolt).
- » Kit 13165 requires electric fuel pump.

APPLICATION	KIT CODE		
AC, PS & ALT Billet PS Pump & Alternator, Chrome Compressor	BA13120	<b>M</b>	\$2398.95
AC, PS & ALT Chrome Accessories	CA13120	<b>M</b>	\$1799.95
PS & ALT Billet Accessories	BA13105	<b>M</b>	\$2098.95
PS & ALT Chrome Accessories	CA13105	<b>M</b>	\$1539.95

## PONTIAC V8 | ALL-INCLUSIVE SERPENTINE SYSTEM

**ULTRA**



SKU  
CA13105-08

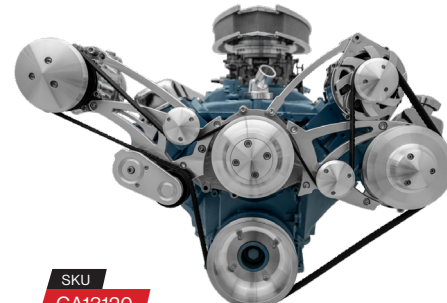

SKU  
CA13120



### KIT DETAILS

- » Price includes new water pump, alternator, Sanden style 508 AC compressor, power steering pump, brackets, pulleys and hardware.
- » Requires 1968+ balancer (4 bolt w/o casted V-Groove).
- » Requires 1969+ timing cover (11 bolt)

# PONTIAC ENGINES

## ULTRA

### ULTRA SERIES SERPENTINE CONVERSION



SKU  
13105-08

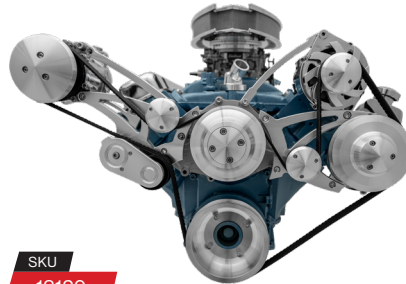

SKU  
13120

#### KIT DETAILS

- » Price includes all brackets, pulleys & hardware.
- » Requires Sanden Style 508 AC compressor (March #P2413).
- » Requires 1968+ balancer w/o V-Groove.
- » Requires 1969+ 11 bolt water pump (March #P2174).



APPLICATION	KIT CODE	PRICE
AC, PS & ALT Saginaw Keyway	13120	<b>M</b> \$1123.95
AC, PS & ALT Saginaw Press Fit	13125	<b>M</b> \$1123.95
PS & ALT Saginaw Keyway	13105	<b>M</b> \$711.95
PS & ALT Saginaw Press Fit	13110	<b>M</b> \$711.95
ALTERNATOR ONLY	13100	<b>M</b> \$473.95

## ULTRA

### MID-MOUNT ULTRA SERIES SERPENTINE CONVERSION



SKU  
13020-08



SKU  
13015

#### KIT DETAILS

- » Price includes all brackets, pulleys & hardware.
- » Requires peanut style 7176 AC compressor (March #P2412).
- » Requires 1968+ balancer w/o V-Groove.
- » Requires 1969+ 11 bolt water pump (March #P2174).



APPLICATION	KIT CODE	PRICE
AC, PS & ALT Saginaw Keyway, 7176 AC	13020	<b>M</b> \$879.95
PS & ALT Saginaw Keyway	13015	<b>M</b> \$699.95
ALTERNATOR ONLY	13025	<b>M</b> \$489.95

#### Optional Add-on Accessories:

- » Billet hood hinges for various Pontiac applications including Firebird, GTO, Tempest & LeMans.

SKU  
HH81P



### V-BELT PULLEY KITS

PULLEYKIT	PULLEY RATIO	WATER PUMP PULLEY	CRANKSHAFT PULLEY	ALTERNATOR PULLEY
13010 <b>\$254</b>	PERFORMANCE	1V 13012 (6.125") <b>\$109</b>	1V 13011 (6.125") <b>\$94</b>	1V 137 (2.69") <b>\$56</b>
13030 <b>\$264</b>	PERFORMANCE	2V 13032 (6.125") <b>\$119</b>	2V 13031 (6.125") <b>\$106</b>	1V 137 (2.69") <b>\$56</b>
13050 <b>\$274</b>	PERFORMANCE	2V 13032 (6.125") <b>\$119</b>	3V 13051 (6.125") <b>\$118</b>	1V 137 (2.69") <b>\$56</b>



- » Requires 1968+ balancer w/o v-groove.
- » Requires 1969+ 11 bolt water pump (March #P2174).



# CADILLAC/SUBARU ENGINES



## CADILLAC V8 | ALL INCLUSIVE SERPENTINE SYSTEM

APPLICATION	KIT CODE	
AC, PS & ALT <small>GM Type II Remote PSPump</small>	21525	<b>M</b> \$2199. <sup>95</sup>
AC & ALT	21520	<b>M</b> \$2099. <sup>95</sup>

### Optional Add-on Accessories:

» Remote power steering reservoir.



SKU  
450



SKU  
21520-07



SKU  
21525

### KIT DETAILS

- » Price includes new water pump, alternator, peanut style AC compressor, power steering pump, brackets, pulleys and hardware.
- » Compatible with 425, 472-500 Cadillac V8 Engines from 1968-1976



## SUBARU EJ SERIES SERPENTINE PULLEYS



- » Compatible with 1993-2020 Subaru EJ Engines
- » 70% lighter than OEM pulleys adding an additional 5-10 horsepower and torque.
- » Utilizes OEM 5 Rib serpentine belt.



PULLEY KIT	CRANKSHAFT PULLEY	POWER STEERING PULLEY	ALTERNATOR PULLEY
S-SUB2KIT \$285	S-EJ2CR \$119	S-EJ1PS \$97	S-EJ1ALT \$75



## EXCEPTIONALLY STYLED AIR CLEANERS. THE FINISHING TOUCH TO ALL TOP OF THE LINE BUILDS.

MARCH PERFORMANCE BILLET AIR CLEANERS ARE DESIGNED TO FIT SINGLE FOUR BARREL CARB APPLICATIONS. SEE THE FULL LINEUP ON PAGE 60.



# OLDSMOBILE ENGINES



## OLDSMOBILE V8 | ALL INCLUSIVE STYLE TRACK



SKU  
16035-08

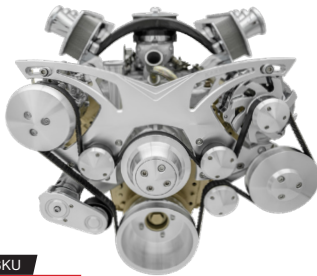

SKU  
16030

### KIT DETAILS

- » Price includes water pump, timing cover, alternator, power steering pump, brackets, pulleys and hardware. Remote reservoir and belt not included.
- » Compatible with all Oldsmobile 350 Rocket, 403, 455 and Oldsmobile 400 (1968-69) engines.

### APPLICATION

AC, PS & ALT  
GM Type II Remote PS  
AC & ALT

### KIT CODE

16030 **M** \$2199.95  
16035 **M** \$2099.95

### Optional Add-on Accessories:

- » Remote power steering reservoir.



SKU  
450



## OLDSMOBILE V8 | ULTRA SERPENTINE CONVERSION

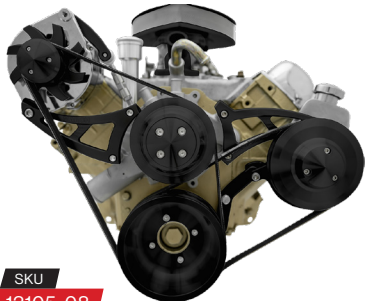

SKU  
13105-08

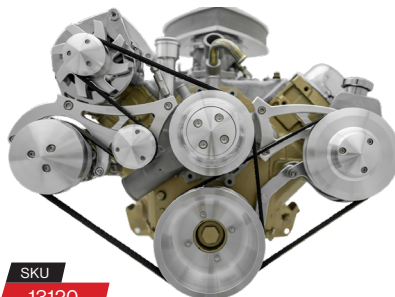

SKU  
13120

### KIT DETAILS

- » Price includes all brackets, pulleys & hardware.
- » Compatible with all Oldsmobile 350 Rocket, 403, 455 and Oldsmobile 400 (1968-69).
- » Requires 6" tall water pump (March #P151).
- » Utilizes Peanut Style 7176 AC Compressor (P2412) & Saginaw pump with keyway shaft (P2304).

### APPLICATION

AC, PS & ALT  
350 Rocket Engines  
AC, PS & ALT  
455 Engines  
PS & ALT  
350 Rocket Engines  
PS & ALT  
455 Engines  
ALTERNATOR ONLY  
350 Rocket Engines  
ALTERNATOR ONLY  
455 Engines

### KIT CODE

16040 **M** \$899.95  
16045 **M** \$899.95  
16020 **M** \$699.95  
16065 **M** \$699.95  
16015 **M** \$499.95  
16060 **M** \$499.95



## INDIVIDUAL V-BELT PULLEYS & ACCESSORIES

PULLEY KIT	PULLEY RATIO	WATER PUMP PULLEY		CRANKSHAFT PULLEY		ALTERNATOR PULLEY	
16083 <b>\$269</b>	HIGHFLOW	2V	16082 (5.25") <b>\$114</b>	2V	16081 (6.25") <b>\$139</b>	1V	137 (2.69") <b>\$56</b>

» Requires 5.25" water pump.



Billet oil fill tube for Oldsmobile 350 & 455 engines. Available in black or clear.

SKU  
16012

**M** \$129.95

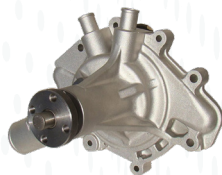

High flow aluminum water pump for Oldsmobile 350 & 455. 6.0" tall.

SKU  
P151

**M** \$140.95





# BUICK ENGINES



APPLICATION	KIT CODE	
AC, PS & ALT GM Type II Remote PSPump	17000	<b>M</b> \$2199.95
AC & ALT	17010	<b>M</b> \$2099.95

## BUICK V8 | ALL INCLUSIVE SERPENTINE SYSTEM

### Optional Add-on Accessories:

» Billet air cleaner. Includes billet hold down and filter.



SKU  
9760



SKU  
17010-08



SKU  
17000



### KIT DETAILS

» Price includes new water pump, alternator, peanut style AC compressor, power steering pump, brackets, pulleys and hardware. Remote reservoir and belt not included.  
» Compatible with 400, 430 & 455 Buick V8 Engines.

## INDIVIDUAL V-BELT PULLEYS | BUICK BIG BLOCK

PULLEY TYPE	PULLEY CODE		
<b>CRANKSHAFT</b> Short Water Pump, 6.5" OD.	3V	12051	\$114.95
<b>CRANKSHAFT</b> Long Water Pump, 6.5" OD.	2V	12031	\$116.95
<b>WATER PUMP</b> Short Water Pump, 6.5" OD.	2V	12052	\$109.95
<b>WATER PUMP</b> Long Water Pump, 6.5" OD.	2V	12032	\$109.95
<b>ALTERNATOR</b> 3.25" OD.	2V	172	\$39.95



## INDIVIDUAL SERPENTINE PULLEYS | BUICK GRAND NATIONAL / REGAL TURBO

PULLEY KIT	CRANKSHAFT PULLEY	INTERCOOLER FAN ADAPTER	ALTERNATOR PULLEY
4200-08 \$239	4201-08 (5.25") \$144	4203 \$56	208-08 (2.75") \$61



\*Intercooler adapter is clearcoated



## INDIVIDUAL V-BELT PULLEYS | BUICK 3.8L | 1981 - 1985

PULLEY KIT	PULLEY RATIO	WATER PUMP PULLEY	CRANKSHAFT PULLEY	ALTERNATOR PULLEY
4220 \$289	PERFORMANCE	3V 4222 (6.25") \$119	3V 4221 (5") \$119	1V 137 (2.69") \$56



# BUICK ENGINES

*Style*  
**TRACK**

## BUICK NAILHEAD | STYLE TRACK SERPENTINE SYSTEM



SKU  
17020-08



SKU  
17025

### KIT DETAILS

- » Price includes water pump, timing cover, alternator, power steering pump, brackets, pulleys and hardware. Remote reservoir & belt not included.
- » Compatible with 1962-1966 Buick Nailhead 401-425.

### APPLICATION

AC, PS & ALT  
GM Type II Remote PS

AC & ALT

### KIT CODE

17025

17020

**M** \$2399.<sup>95</sup>

**M** \$2299.<sup>95</sup>

### Optional Add-on Accessories:

- » Premium 6 rib belt.  
Lengths needed:  
17025: 85"  
17020: 83.5"



*Noctalgia*  
**SERIES**

## BUICK NAILHEAD | NOSTALGIA SERPENTINE SYSTEM



SKU  
17040-07

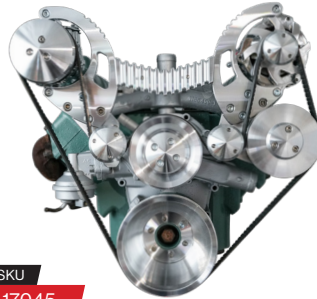

SKU  
17045

### KIT DETAILS

- » Price includes water pump, timing cover, alternator, power steering pump, brackets, pulleys and hardware. Remote reservoir and belt not included.
- » Compatible with 1962-1966 Buick Nailhead 401-425.

### APPLICATION

AC, PS & ALT  
GM Type II Remote PS

AC & ALT

### KIT CODE

17045

17040

**M** \$2499.<sup>95</sup>

**M** \$2399.<sup>95</sup>

### Optional Add-on Accessories:

- » Remote power steering reservoir.



SKU  
450



## FAST AND FREE SHIPPING



- » Free shipping on any order over \$199. All other orders ship for a flat rate of \$9.99.
- » All March products are designed, machined, and stocked in our state of the art facility in the USA. This allows us to ship most orders within 24 hours.
- » Near or far, March has you covered. We use multiple shipping carriers to ship all over the world.

# AMC & JEEP ENGINES

APPLICATION	KIT CODE		
AC, PS & ALT GM Type II Remote PS; 3 Bolt Balancer	55120	<b>M</b>	\$2399.95
AC, PS & ALT GM Type II Remote PS; 4 Bolt Balancer	55150	<b>M</b>	\$2399.95
AC & ALT 3 Bolt Balancer	55115	<b>M</b>	\$2299.95
AC & ALT 4 Bolt Balancer	55100	<b>M</b>	\$2299.95

## AMC V8 | ALL-INCLUSIVE SERPENTINE SYSTEM

**Pro-Track**  
Lightweight. Extra Strength. Race Proven.



SKU  
55120



SKU  
55120-07

### KIT DETAILS

- » Price includes new water pump, alternator, peanut style AC compressor, power steering pump, brackets, pulleys and hardware.
- » Compatible with AMC 304-401 Engines (1968-1991).
- » Compatible with Jeep V8 Engines (1971-1991).



APPLICATION	KIT CODE		
PS & ALT Saginaw Keyway; 3 Bolt Balancer	55051	<b>M</b>	\$819.95
PS & ALT Saginaw Keyway; 4 Bolt Balancer	55050	<b>M</b>	\$819.95
ALTERNATOR ONLY 3 Bolt Balancer	55011	<b>M</b>	\$469.95
ALTERNATOR ONLY 4 Bolt Balancer	55010	<b>M</b>	\$469.95

## AMC V8 | ULTRA SERPENTINE CONVERSION

**ULTRA**



SKU  
55010-08



SKU  
55050

### KIT DETAILS

- » Price includes brackets, pulleys & hardware.
- » Compatible with AMC 304-401 Engines (1968-1978).
- » Requires long water pump from 1973+ (4-13/16").

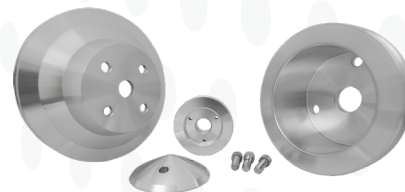

## V-BELT PULLEYKITS

PULLEYKIT		PULLEY RATIO	WATER PUMP PULLEY		CRANKSHAFT PULLEY		ALTERNATOR PULLEY	
5600	\$278	HIGHFLOW	1V	5602 (5.5") \$119	1V	5601 (6.63") \$128	1V	137 (2.69") \$56
5610	\$298	HIGHFLOW	2V	5612 (5.5") \$142	2V	5611 (6.63") \$127	1V	137 (2.69") \$56

» Requires long water pump from 1973+ (4-13/16").

# BILLET AIR CLEANERS



EXCEPTIONALLY STYLED  
AIR CLEANERS. THE  
FINISHING TOUCH TO ALL  
TOP OF THE LINE BUILDS.



MARCH PERFORMANCE BILLET AIR CLEANERS  
ARE DESIGNED TO FIT SINGLE FOUR BARREL CARB  
APPLICATIONS. INCLUDES AIR FILTER & BILLET NUT.



## STYLE TRACK SERIES

**M 9720 (XL)**



**M 9760 (GRANDE)**



**M 9722 (XS)**

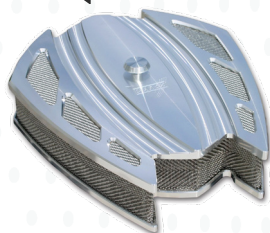

**M 9760-08**



### DESIGN

### KIT CODE

GRANDE Clear finish	9760	\$779.95
GRANDE Black finish	9760-08	\$779.95
GRANDE Chrome finish	9760-06	\$979.95
GRANDE Black Onyx finish	9760-07	\$929.95
XS Clear finish	9722	\$623.95
XS Black finish	9722-08	\$623.95
XS Chrome finish	9722-06	\$823.95
XL Clear finish	9720	\$899.95
XL Black Onyx finish	9720-07	\$1049.95



## REVOLVER | PRO TRACK | FUTURA SERIES



**M 9740**



**M 9750-07**



**M 9730-06**

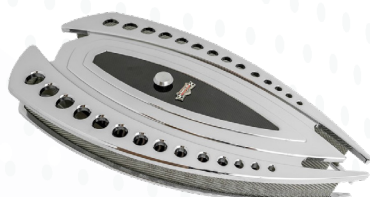

**M 9700**



### DESIGN

### KIT CODE

REVOLVER GRANDE Clear finish	9740	\$714.95
REVOLVER GRANDE Black Onyx finish	9740-07	\$864.95
REVOLVER Clear finish	9730	\$899.95
REVOLVER Chrome finish	9730-06	\$1099.95
FUTURA Clear finish	9700	\$522.95
FUTURA Chrome finish	9700-06	\$722.95
FUTURA Black Onyx finish	9700-07	\$672.95
PRO-TRACK Clear finish	9750	\$999.95
PRO-TRACK Black finish	9750-08	\$999.95
PRO-TRACK Black Onyx finish	9750-07	\$1149.95



# BILLET AIR CLEANERS

## CARBON SPIDER SERIES

DESIGN	KIT CODE	
<b>CARBON SPIDER</b> Clear finish	9860	\$1279. <sup>95</sup>
<b>CARBON SPIDER</b> Black finish	9860-08	\$1279. <sup>95</sup>
<b>CARBON SPIDER</b> Chrome finish	9860-06	\$1479. <sup>95</sup>
<b>CARBON SPIDER QUAD</b> Clear finish	9880	\$1199. <sup>95</sup>
<b>CARBON SPIDER QUAD</b> Black finish	9880-08	\$1199. <sup>95</sup>
<b>CARBON SPIDER QUAD</b> Chrome finish	9880-06	\$1399. <sup>95</sup>
<b>CARBON SPIDER QUAD</b> Black Onyx finish	9880-07	\$1349. <sup>95</sup>
<b>CARBON SPIDER FUELIE</b> Clear finish	9870	\$1599. <sup>95</sup>
<b>CARBON SPIDER FUELIE</b> Black finish	9870-08	\$1599. <sup>95</sup>
<b>CARBON SPIDER FUELIE</b> Chrome finish	9870-06	\$1799. <sup>95</sup>



**M 9860**



**M 9880**



**M 9870**



## FUELIE SERIES

DESIGN	KIT CODE	
<b>FUELIE</b> Clear finish	9755	\$1399. <sup>95</sup>
<b>FUELIE</b> Black finish	9755-08	\$1399. <sup>95</sup>
<b>FUELIE</b> Chrome finish	9755-06	\$1599. <sup>95</sup>
<b>FUELIE</b> Black Onyx finish	9755-07	\$1549. <sup>95</sup>
<b>FUELIE GRANDE</b> Clear finish	9820	\$1119. <sup>95</sup>
<b>FUELIE GRANDE</b> Black finish	9820-08	\$1119. <sup>95</sup>
<b>FUELIE GRANDE</b> Chrome finish	9820-06	\$1319. <sup>95</sup>
<b>FUELIE GRANDE</b> Black Onyx finish	9820-07	\$1269. <sup>95</sup>

**M 9755**

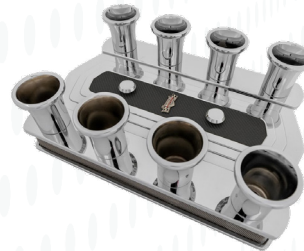

**M 9755-08**



**M 9820**



**M 9820-07**



# BILLET HOOD HINGES

## M PREMIUM FINISH

All March hood hinges are available in 4 distinct finishes: polished, black, clear coat and black onyx.

## M HOOD CLEARANCE

All March hood hinges are designed to meet or exceed the OEM hood opening angle, a feature exclusive to March.

## M MICRO ADJUSTMENT

Internal set screws rest on the mounting block to keep it in place as the bolt is loosened, allowing simple height adjustments.

## M GAS-POWERED STRUTS

Our ideal combination of fitting the correct force strut with the hood type is the key to opening and closing power of the hood.

## ALL NEW, ALL PREMIUM MARCH HOOD HINGES. INNOVATIVE DESIGN WITH INSTALLATION IN MIND.

Our patented **6-Axis Adjustability** hinge design allows one person to easily adjust hood gaps and positioning with complete precision.

PATENTED  
US 11,002,047

## M CAM BUTTON TECHNOLOGY

Take the stress and time out of adjusting hood fitment by easily adjusting the buttons to shift the hood side-to-side or at an angle.

## M ADJUSTING ROD

Allows for final rear height adjustments in very small increments to get the hood gaps perfect.



M HH79FT



### FORD CARS & TRUCKS | MERCURY | 1964 - 1979



M HH66M-07



M HH72FT-05



M HH79FB

» Listed price is for polished hinges. All hinges also available in black (+\$50), clear (+\$50), and black onyx (+\$200).  
» Price includes pair of hinges, struts and all mounting hardware.



APPLICATION	KIT CODE	
FORD F SERIES 1967 - 1972, Gen V	HH72FT	\$595.00
FORD F SERIES 1973 - 1979, Gen VI	HH79FT	\$595.00
FORD BRONCO 1978 - 1979, Gen II	HH79FB	\$595.00
FORD MUSTANG 1964 - 1966, Gen I	HH66M	\$595.00
FORD MUSTANG 1967 - 1970, Gen II	HH70M	\$595.00
FORD FALCON 1964 - 1966, Gen II	HH65FF	\$595.00
FORD RANCHERO 1964 - 1966, Gen II	HH65FR	\$595.00
MERCURY COMET 1965, Gen II	HH65MC	\$595.00
MERCURY COUGAR 1967 - 1970, Gen I	HH70MCG	\$595.00

### PONTIAC VEHICLES



M HH81P-07



M HH69P-05



M HH67GTO

APPLICATION	KIT CODE	
PONTIAC FIREBIRD 1967 - 1969, Gen I	HH69P	\$595.00
PONTIAC FIREBIRD 1970 - 1981, Gen II	HH81P	\$595.00
PONTIAC GTO 1964 - 1967, Gen I	HH67GTO	\$595.00
PONTIAC LEMANS 1964 - 1967, Gen I	HH67LEM	\$595.00
PONTIAC TEMPEST 1964 - 1967, Gen I	HH67TEMP	\$595.00
PONTIAC BONNEVILLE 1982 - 1986, Gen VII	HH86BON	\$595.00

# BILLET HOOD HINGES

## CHEVY VEHICLES | PONY | COMPACT | FULL SIZE | 1955 - 1987



**M** HH72CE-07



**M** HH81C



**M** HH69C



**M** HH72CE-07

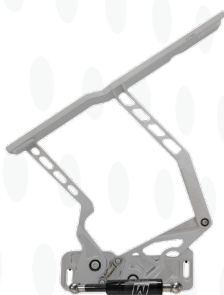

**M** HH81C



**M** HH65NV

APPLICATION	KIT CODE	
CHEVY CAMARO 1967 - 1969, Gen I	HH69C	\$595.00
CHEVY CAMARO 1970 - 1981, Gen II	HH81C	\$595.00
CHEVELLE & EL CAMINO 1965 - 1967, Gen I Chevelle, Gen II El Camino	HH67CE	\$595.00
CHEVELLE & EL CAMINO 1968 - 1972, Gen II Chevelle, Gen III El Camino	HH72CE	\$595.00
CHEVY IMPALA 1965 - 1967, Gen IV	HH67IA	\$595.00
CHEVY IMPALA 1971 - 1976, Gen V	HH76I	\$595.00
CHEVY BEL AIR 1965 - 1967, Gen VI	HH67BA	\$595.00
CHEVY BISCAYNE 1965 - 1967, Gen IV	HH67BS	\$595.00
CHEVY CAPRICE 1966 - 1967, Gen I	HH67CAP	\$595.00
CHEVY CAPRICE 1971 - 1976, Gen II	HH76CAP	\$595.00
CHEVY NOVA 1963 - 1965, Gen I	HH65NV	\$595.00
CHEVY NOVA 1966 - 1967, Gen II	HH67NV	\$595.00
CHEVY NOVA 1968 - 1974, Gen III	HH74NV	\$595.00
CHEVY MONTE CARLO 1982 - 1988, Gen IV	HH88MC	\$595.00

» Most GM hinges are compatible w/ multiple vehicles. Visit [Marchperformance.com](http://Marchperformance.com) for all applications.

## CHEVY TRUCKS | 1960 - 1987



**M** HH66CK-08



**M** HH72CK



**M** HH80CK-07

**M** HH87C10-05



APPLICATION	KIT CODE	
CHEVY C10 1960 - 1966, Gen I	HH66CK	\$595.00
CHEVY C10 1967 - 1972, Gen II	HH72CK	\$595.00
CHEVY C10 1973 - 1980, Gen III	HH80CK	\$595.00
CHEVY C10 1981 - 1987, Gen IV	HH87C10	\$595.00
CHEVY C10 - SLOSH TUBZ™ 1973 - 1980, Gen III, Modified Inner Fenders	HH80CKS	\$595.00

» Listed price is for polished hinges. All hinges also available in black (+\$50), clear (+\$50), and Black Onyx (+\$200).  
» Price includes pair of hinges, struts and all mounting hardware.



## OLDSMOBILE | BUICK VEHICLES

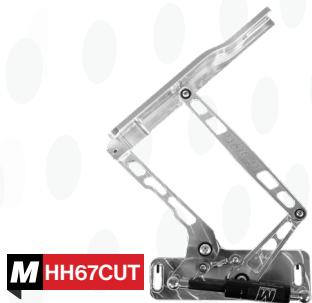

**M** HH67CUT



**M** HH87REG

APPLICATION	KIT CODE	
OLDSMOBILE CUTLASS 1964 - 1967, Gen I	HH67CUT	\$595.00
OLDSMOBILE CUTLASS 1982 - 1988, Gen VI, Supreme	HH88CUT	\$595.00
BUICK REGAL 1982 - 1987, Gen II, G-Body Platform	HH87REG	\$595.00
BUICK SKYLARK 1965, Gen I	HH65SKY	\$595.00

# BILLET TRUNK HINGES

## M OEM COMPATIBLE

All March trunk hinges are designed to OEM specifications. No hole drilling required. Ever.

## M PREMIUM FINISH

All March trunk hinges are available in our 4 distinct finishes: polished, black, clear and black onyx.

## M CAM BUTTON TECHNOLOGY

Similar to March hood hinges, our trunk hinges utilize the same cam button technology to fix lid gaps in no time at all.

## M MICRO ADJUSTMENT

Internal set screws rest on the mounting block to keep it in place as the bolt is loosened, allowing simple height adjustments.

## M VERTICAL ADJUSTMENT

Trunk hinges include a built in adjustability feature to raise and lower the lid. \*Not available for all applications.

## M GAS-POWERED STRUTS

Our ideal combination of fitting the correct force strut with the lid type is the key to the opening and closing power of the trunk.

## PREMIUM MARCH TRUNK HINGES. INNOVATIVE DESIGN WITH INSTALLATION IN MIND.

Our 6-Axis adjustability hinge design allows one person to easily adjust trunk gaps and positioning with complete precision. No drilling required, ever.



## M TH55C-07

- » Listed price is for polished hinges. Also available in black (+\$50), clear (+\$50), and Black Onyx (+\$100).
- » Price includes pair of hinges, struts and all mounting hardware.



APPLICATION	KIT CODE	
CHEVY CAMARO 1967 - 1969; Gen I	TH69C	\$374.99
CHEVY BELAIR, 210, NOMAD 1955 - 1956; Post Vehicles Only	TH55C	\$374.99
CHEVY IMPALA 1962; Gen III	TH62I	\$374.99
CHEVY IMPALA 1971 - 1976; Gen V	TH76I	\$374.99
CHEVELLE 1968 - 1972; Gen II Chevelle	HH67IA	\$374.99
CHEVY NOVA 1962 - 1966; Gen I; Coupe/Convertible	TH65NC	\$374.99
CHEVY NOVA 1966 - 1967; Gen II	TH67N	\$374.99
CHEVY NOVA 1968 - 1974; Gen III	TH74N	\$374.99
FORD MUSTANG 1964 - 1966; Gen I; Convertible	TH66MC	\$374.99
PLYMOUTH CUDA 1970 - 1974; Gen III	TH74C	\$374.99
CHEVY CORVETTE 2020 - 2023; Rear Engine Hatch Strut Mount	SMB9720	\$399.95



# INTERIOR ACCESSORIES

## UNIVERSAL SHIFT LEVER - ADJUSTABLE

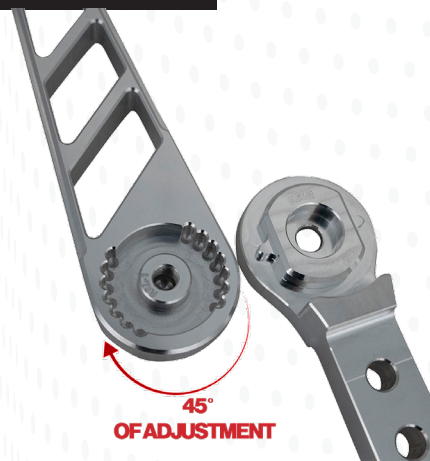

- » Available in 6, 8, and 10" lengths
- » Base can be adjusted to work at 0, 15, 30 & 45° angles.
- » Available in 4 finishes: Polished, Black Anodize, Clear Coat and Black Onyx.
- » Direct bolt on for 7/8" bolt patterns including Tremec T5, T45, T56, TKO, TR6060 & Magnum.



LEVER LENGTH	SKU	PRICE
6" Lever	6MASL-1-KIT	\$149
8" Lever	8MASL-1-KIT	\$159
10" Lever	10MASL-1-KIT	\$169

\*Listed price is for polished finish.

## UNIVERSAL DOOR AND WINDOW CRANKS



**M CARBON FIBER**



**M SLOTTED**



**M TRIANGLE**

- » Universal handles and cranks can be used w/ GM, Ford, and Chrysler vehicles.
- » Simple spline adapter attachment.
- » Sold as a pair. Includes all mounting hardware for a simple installation.
- » Available in 3 unique designs including slotted, triangle, and solid w/ a carbon fiber inlay.



## DOOR JAMB LOUVRES | VENTS



**M DJV-97CT**



**M DJV-69CAM-07**

APPLICATION	KIT CODE	PRICE
<b>CHEVY TRUCKS</b> 1988-1998, Old Body Style (OBS), Pair	DJV-98CT	\$169.99
<b>CHEVY C10 TRUCKS</b> 1971-1972, C10, Single	DJV-72CT	\$78.99
<b>CHEVY CAMARO</b> 1968-1969, Gen I, Pair	DJV-69CAM	\$148.99
<b>CHEVY CAMARO</b> 1970-1981, Gen II, Pair	DJV-81CAM	\$148.99



# ALTERNATORS ULTRA SERIES



## MARCH ULTRA SERIES ALTERNATORS. GUARANTEED TO GET YOU HOME FOR LIFE.

- » All March Performance Ultra Series alternators are backed by an industry leading lifetime warranty.
- » Utilize a 1-wire connection for a quick and easy install.
- » Full range of makes and models including GM, Ford and Chrysler w/ AMP ranges from 50 to 320.
- » 100% tested in the USA.

CENTER OFFSET ALTERNATOR

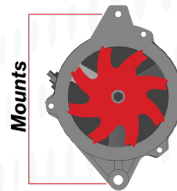

LEFT OFFSET ALTERNATOR

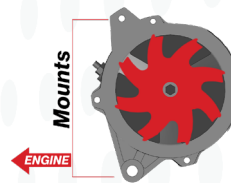

RIGHT OFFSET ALTERNATOR

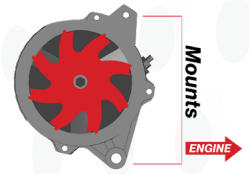

### GM ALTERNATORS | CS130 | 140 AMP

			
Chrome finish CS130 alternator. 1 Wire. Available in center, left, and right mounting offsets.	Polished finish CS130 alternator. 1 Wire. Available in center, left, and right mounting offsets.	Black finish CS130 alternator. 1 Wire. Available in center, left, and right mounting offsets.	Cast finish CS130 alternator. 1 Wire. Available in center, left, and right mounting offsets.
<b>CENTER</b> <b>P2572-06</b> <b>\$198.<sup>95</sup></b>	<b>CENTER</b> <b>P2572-05</b> <b>\$218.<sup>95</sup></b>	<b>CENTER</b> <b>P2572-08</b> <b>\$198.<sup>95</sup></b>	<b>CENTER</b> <b>P2572-04</b> <b>\$194.<sup>95</sup></b>
<b>LEFT</b> <b>P2525-06</b> <b>\$198.<sup>95</sup></b>	<b>LEFT</b> <b>P2525-05</b> <b>\$235.<sup>95</sup></b>	<b>LEFT</b> <b>P2525-08</b> <b>\$189.<sup>95</sup></b>	<b>LEFT</b> <b>P2525-04</b> <b>\$179.<sup>95</sup></b>
<b>RIGHT</b> <b>P2568-06</b> <b>\$198.<sup>95</sup></b>	<b>RIGHT</b> <b>P2568-05</b> <b>\$218.<sup>95</sup></b>	<b>RIGHT</b> <b>P2568-08</b> <b>\$188.<sup>95</sup></b>	<b>RIGHT</b> <b>P2568-04</b> <b>\$194.<sup>95</sup></b>

» Additional CS130 alternators can be found on page 67 under "high amperage".

### GM ALTERNATORS | 10SI

			
Chrome Finish 10 SI Alternator. Available in 100 or 140 AMPs.	Polished Finish 10 SI Alternator. Available in 100 or 140 AMPs.	Black finish 10 SI alternator. Available in 100 or 140 AMPs.	10 SI 140 AMP alternator with a CNC machined billet case by March Performance. Available in clear, black & chrome.
<b>100A</b> <b>P2555-06</b> <b>\$119.<sup>95</sup></b>	<b>100A</b> <b>P2555-05</b> <b>\$129.<sup>95</sup></b>	<b>100A</b> <b>P2555-08</b> <b>\$114.<sup>95</sup></b>	<b>Clear</b> <b>9650</b> <b>\$548.<sup>95</sup></b>
<b>140A</b> <b>P2556-06</b> <b>\$139.<sup>95</sup></b>	<b>140A</b> <b>P2556-05</b> <b>\$159.<sup>95</sup></b>	<b>140A</b> <b>P2556-08</b> <b>\$134.<sup>95</sup></b>	<b>Black</b> <b>9650-08</b> <b>\$548.<sup>95</sup></b>
			<b>Chrome</b> <b>9650-06</b> <b>\$699.<sup>95</sup></b>

» Additional 10 SI alternators can be found on page 67 under "high amperage".

# ALTERNATORS ULTRA SERIES

## HIGH AMPERAGE ALTERNATORS | GM10SI | CS130



Chrome finish 320 AMP alternator.



Polished finish 320 AMP alternator.



Black finish 320 AMP alternator.

<b>CS130</b>	<b>P545</b>	<b>\$738.<sup>12</sup></b>
<b>10SI</b>	<b>P535</b>	<b>\$738.<sup>12</sup></b>

<b>CS130</b>	<b>P540</b>	<b>\$738.<sup>12</sup></b>
<b>10SI</b>	<b>P530</b>	<b>\$738.<sup>12</sup></b>

<b>CS130</b>	<b>P548</b>	<b>\$738.<sup>12</sup></b>
<b>10SI</b>	<b>P538</b>	<b>\$738.<sup>12</sup></b>

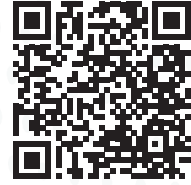

» High amperage alternators are not covered by March's lifetime warranty, but are covered by Mechman™ for two years.

## FORD ALTERNATORS | 1G



Chrome finish 1G alternator. Available in 100 or 140 AMPs.



Polished finish 1G alternator. Available in 100 or 140 AMPs.



Black finish 1G alternator. Available in 100 or 140 AMPs.



1G 140 AMP alternator with CNC machined billet case by March Performance. Available in clear, black & chrome.

<b>100A</b>	<b>P2562-06</b>	<b>\$139.<sup>95</sup></b>
<b>140A</b>	<b>P2563-06</b>	<b>\$198.<sup>95</sup></b>

<b>100A</b>	<b>P2562-05</b>	<b>\$148.<sup>95</sup></b>
<b>140A</b>	<b>P2563-05</b>	<b>\$218.<sup>95</sup></b>

<b>100A</b>	<b>P2562-08</b>	<b>\$134.<sup>95</sup></b>
<b>140A</b>	<b>P2563-08</b>	<b>\$154.<sup>95</sup></b>

<b>Clear</b>	<b>9665</b>	<b>\$542.<sup>99</sup></b>
<b>Black</b>	<b>9665-08</b>	<b>\$542.<sup>99</sup></b>
<b>Chrome</b>	<b>9665-06</b>	<b>\$841.<sup>93</sup></b>

## ADDITIONAL ALTERNATORS | CHRYSLER | MINI | WIRING HARNESS



Chrysler style 100 AMP alternator w/ chrome finish. Compatible with Small (SCR) & Big Block (BCR). Includes pulley.

<b>SCR</b>	<b>P590</b>	<b>\$139.<sup>95</sup></b>
<b>BCR</b>	<b>P595</b>	<b>\$244.<sup>13</sup></b>

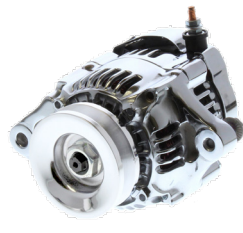

Chrome plated mini 50 AMP alternator. Included w/ kit #20201.

<b>50A</b>	<b>P520</b>	<b>\$314.<sup>95</sup></b>
------------	-------------	----------------------------



Painless Performance alternator wiring kit for 100-190 AMP alternators.

<b>30700</b>	<b>\$84.<sup>99</sup></b>
--------------	---------------------------



Universal alternator fan. Available in clear, black and chrome plating.

<b>Clear</b>	<b>221</b>	<b>\$55.<sup>99</sup></b>
<b>Black</b>	<b>221-08</b>	<b>\$55.<sup>99</sup></b>
<b>Chrome</b>	<b>221-06</b>	<b>\$83.<sup>99</sup></b>

# POWER STEERING PULLEYS

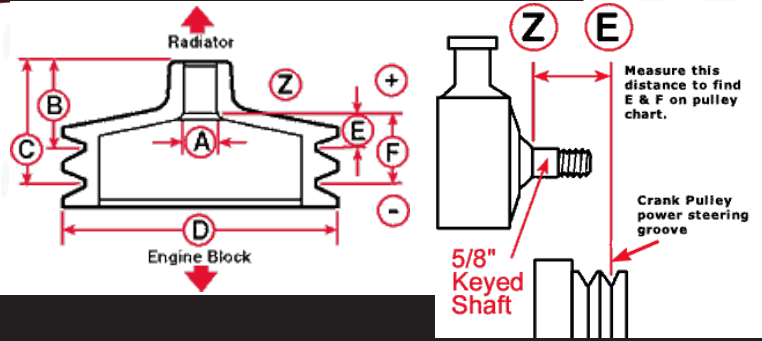

## V-BELT POWER STEERING PULLEYS

PULLEY	APPLICATION	ATTACHMENT	SHAFT SIZE (A)	1 <sup>ST</sup> GROOVE (B)	2 <sup>ND</sup> GROOVE (C)	O.D. SIZE (D)	1 <sup>ST</sup> GROOVE (E)	2 <sup>ND</sup> GROOVE (F)	OEM PART #
500	\$88 Ford, Saginaw	Press Fit	3/4"	1.33"		6.0"			
502	\$85 BBF, Corporate	Press Fit	11/16"	1.336"		5.5"			
504	\$88 SBF, Corporate	Press Fit	11/16"	0.87"		5.0"			
505	\$88 Ford, Corporate	Press Fit	11/16"	0.42"		5.0"	0.58"		
510	\$85 SBC/BBC, Short WP	Keyway	5/8"	0.913"		5.75"	-0.163"		38860457
511	\$82 SBC/BBC, Short WP	Press Fit	3/4"	1.15"		5.75"			346289AK
512	\$82 SBC/BBC	Keyway	5/8"	1.36"		5.75"	-0.55"		2477954
513	\$85 SBC/BBCLWP, Chrysler	Keyway	5/8"	1.05"		5.75"	-0.30"		3770509CE
515	\$103 SBC/BBC, Short WP	Press Fit	3/4"	1.95"		6.0"			140231761
516	\$85 SBC/BBC	Keyway	5/8"	0.42"		5.75"	0.33"		
520	\$93 SBC/BBCLWP	Press Fit	3/4"	1.55"	2.175"	5.75"			354325AC
521	\$93 SBC/BBCLWP	Keyway	5/8"	1.07"	1.69"	5.75"	-0.32"	-0.94"	3491107DE
522	\$93 SBC/BBC	Press Fit	3/4"	1.35"	1.96"	6.0"			14023173DB
523	\$89 GM/CHRYSLER/PONT	Keyway	5/8"	1.07"		5.75"	-0.32"		
526	\$109 GM Type II Pump	Press Fit	17MM	0.351"		5.7"	0.713"		
527	\$99 GM Type II Pump	Press Fit	17MM	0.428"		5.625"	1.05"		
530	\$85 Chrysler 440	Keyway	5/8"	0.57"		6.75"	.018"		
531	\$85 Chrysler 440	Press Fit	3/4"	1.25"		6.0"			14023172DA
532	\$99 Chrysler, Federal	Press Fit	5/8"	0.45"		7.0"			3925537DC
540	\$85 GM, Chrysler, Pont. 2V/3V	Keyway	5/8"	0.812"		6.0"	0"		

## SERPENTINE POWER STEERING PULLEYS

PULLEY	APPLICATION	ATTACHMENT	SHAFT SIZE	RIBS (#)	O.D. SIZE	OEM PART #
533	\$124 SB Chrysler, Saginaw	Keyway	5/8"	6	5.0"	
534	\$113 SB Chrysler, Saginaw	Press Fit	3/4"	6	5.0"	
535	\$112 BB Chrysler, Saginaw	Keyway	5/8"	6	5.0"	
538	\$119 Viper, '96-02	Press Fit	17MM	7	6.0"	
539	\$119 Viper, '92-95	Press Fit	17MM	7	6.0"	
610	\$93 BBC/SWP	Press Fit	3/4"	6	6.375"	1410296NL
619	\$97 GM Type II	Press Fit	17MM	6	5.50"	
620	\$124 BB Chrysler, Saginaw	Press Fit	3/4"	6	5.0"	
623	\$85 SBC/BBCLWP, Ford	Keyway	5/8"	6	5.91"	
624	\$85 SBC/BBCLWP, Ford	Press Fit	3/4"	6	5.50"	
630	\$93 5.0L SBF, '79-93	Press Fit	11/16"	6	5.50"	
632	\$93 302 MUSTANG, '94-95	Press Fit	11/16"	6	5.70"	
645	\$88 '91-97 MAGNUM	Press Fit	19MM	7	5.70"	
646	\$85 '91-97 MAGNUM	Press Fit	19MM	6	5.70"	



» All pulleys are for Saginaw power steering pumps unless noted.

# POWER STEERING PUMPS





**MARCH ULTRA SERIES POWER STEERING PUMPS. TOP OF THE LINE QUALITY AT AN UNBEATABLE PRICE, BACKED FOR LIFE.**

## ULTRA SERIES | SAGINAW POWER STEERING PUMPS

			
Chrome finish Saginaw P-series power steering pump w/ 5/8" keyway shaft or 3/4" press fit. 5/8"-18 inverted flare pressure fitting, 3/8" barbed return. 1300 PSI.	Black finish Saginaw P-series power steering pump w/ 5/8" keyway shaft or 3/4" press fit. 5/8"-18 inverted flare pressure fitting, 3/8" barbed return. 1300 PSI.	Billet case Saginaw P-series power steering pump w/ 5/8" keyway shaft or 3/4" press fit. 5/8"-18 inverted flare pressure fitting, 3/8" barbed return. 1300 PSI. Available in clear, black (-08), & chrome (-06).	Replacement Saginaw locknut and woodruff key. Both items are included w/ March Saginaw pumps w/ keyway shaft.
<b>Keyway</b> <b>P2304</b> \$169. <sup>95</sup>	<b>Keyway</b> <b>P2304-08</b> \$159. <sup>95</sup>	<b>Keyway</b> <b>9600</b> \$329. <sup>99</sup>	<b>S645</b> \$4. <sup>95</sup>
<b>Press Fit</b> <b>P350</b> \$235. <sup>37</sup>	<b>Press Fit</b> <b>P349</b> \$172. <sup>89</sup>	<b>Press Fit</b> <b>9615</b> \$380. <sup>99</sup>	<b>#3 X 1/8 X 1/2 WOODRUFF KEY</b> \$2. <sup>97</sup>

## ULTRA SERIES | GM TYPE II POWER STEERING PUMPS

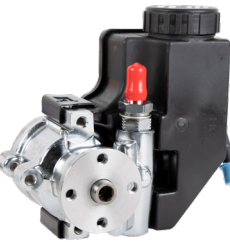
			
Chrome GM Type II pump. Includes pressed on hub. Shaft size of .664", 16mm x 1.5 o-ring pressure outlet, 5/8" barbed inlet. 1300 PSI. Use "-04" for cast finish.	Black GM Type II pump. Includes pressed on hub. Shaft size of .664", 16mm x 1.5 o-ring pressure outlet, 5/8" barbed inlet. 1300 PSI.	GM Type II pump w/ attached plastic reservoir. -6AN pressure fitting, 3/8" barbed return. Available in chrome, black (-08) or cast (-04).	Billet cover for GM Type II power steering pumps w/ remote reservoir. Available in clear, black (-08) and chrome (-06).
<b>P2313-06</b> \$149. <sup>99</sup>	<b>P2313-08</b> \$149. <sup>95</sup>	<b>P2343</b> \$189. <sup>95</sup>	<b>480</b> \$90. <sup>95</sup>

## FORD POWER STEERING PUMPS & ACCESSORIES

	
Ford 5.0L Mustang power steering pump. Includes factory Ford fittings and 11/16 press fit shaft. Available in black.	Power steering pump pressure regulator kit for reducing GM power steering pump pressures to match a desired psi for power steering racks or gear boxes.
<b>P332</b> \$133. <sup>96</sup>	<b>P306</b> \$31. <sup>95</sup>



## PLUMBING SIMPLIFIED. MARCH POWER STEERING LINES AND RESERVOIRS.



### POWER STEERING LINES

Universal power steering line kit for canister style pumps or GM Type II pumps w/ attached reservoirs. Includes (2) 3' section of braided hose and 10 fittings.		Universal power steering line kit for remote reservoir power steering pumps. Includes (3) 3' section of braided hose and 13 fittings.	
STAINLESS	<b>PS-LK-SS</b> \$159.99	STAINLESS	<b>PS-LK-REM-SS</b> \$179.99
BLACK	<b>PS-LK-08</b> \$159.99	BLACK	<b>PS-LK-REM-08</b> \$179.99

### Universal Power Steering Line Kits Include:

- 3 Foot -6 AN Stainless Steel High Pressure PTFE Hose (2)
- 6 AN 90° Hose End (2)
- 6 AN to 11/16-18 Inverted Flare Adapter
- 6 AN to 18MM x 1.5 O-Ring Adapter
- 6 AN to 5/8-18 Inverted Flare Adapter (2)
- 6 AN to 16MM x 1.5 O-Ring Adapter
- 6AN to 1/2-20 Inverted Flare Adapter
- Hose Clamp and Chrome Hose Finisher



### POWER STEERING RESERVOIRS

Straight billet remote reservoir for GM Type II power steering pumps. Available w/ firewall mount or system mount bracket. Available in clear, black (-08) and chrome (-06).		Straight billet remote reservoir for GM Type II power steering pumps. Includes firewall mounting bracket. Taller than 420/425. Available in clear, black (-08) and chrome (-06).		Single taper billet remote reservoir for GM Type II power steering pumps. Includes firewall mount or system mount bracket. Available in clear, black (-08) and chrome (-06).		Double taper billet remote reservoir for GM Type II power steering pumps. Includes firewall mount or system mount bracket. Available in clear, black (-08) and chrome (-06).	
FIREWALL MNT	<b>420</b> \$231.95	<b>450</b>	\$206.95	FIREWALL MNT	<b>430</b> \$236.95	FIREWALL MNT	<b>440</b> \$242.95
SYSTEM MNT	<b>425</b> \$248.95			SYSTEM MNT	<b>435</b> \$245.95	SYSTEM MNT	<b>445</b> \$259.95
Plastic economy remote reservoir for GM Type II pumps. 5/8" barb thread return line.		Fabricated reservoir for GM Type II Pumps w/ attached reservoir (P2342). Polished finish.		Fabricated reservoir for GM Type II Pumps w/ attached reservoir (P2342). Black finish.			
<b>P340</b>	\$124.95	<b>P2341-05</b>	\$149.95	<b>P2341-08</b>	\$149.95		

# BILLET ACCESSORIES

## ADAPT YOUR BARBED RADIATOR/WATER PUMP FITTING TO -AN FITTING

**PATENT PENDING**

**M** -16 or 20AN

Choose between a 16 or 20 AN fitting.

**WIDE COMPATIBILITY**

Use for any inlet/outlet with diameters from 1.25-2.0". Lip on radiator must be less than 1.68"

**M** PREMIUM FINISH

All March billet fittings are available in polished, black or a clearcoat finish.

**WELDFREE**

Avoid the hassles of welding on a new fitting. Certified leak proof compression up to 120 PSI.



### AN COMPRESSION FITTING

-16AN	RAD-16-XXX	\$139.95
-20AN	RAD-20-XXX	\$139.95

## ADJUSTABLE RADIATOR SUPPORT BRACKETS

**M** UNBEATABLE DURABILITY

100% CNC machined in the USA from 6061-T6 billet aluminum.

**SWIVEL BASE**

Adjustable swivel base allows for mounting to any vertical or horizontal surface.

**M** RADIATOR THICKNESS

Adjustable clamp provides tight fit on various radiators from 1.5-3.5" thick.



**MOUNTABLE TO ANY SURFACE**



**PATENT PENDING**

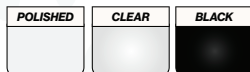

Radiator Thickness	Part #	
1.5 - 2.5"	723668-2	\$79/ea
2.5 - 3.5"	723668-3	\$79/ea

## SIDE MARKER AND TAIL LIGHT BEZELS | LED LIGHTS

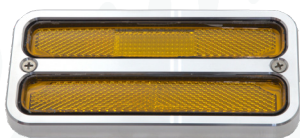

**APPLICATION**

**KIT CODE**

FORD MUSTANG 1964 - 1966, Tail Light Bezel	TLB-66MUS	\$189.99
CHEVROLET CAMARO 1969, PS Tail Light Bezel	TLB-69CAM	\$199.99
CHEVROLET C10 TRUCK 1967 - 1972, Tail Light Bezel	TLB-72CT	\$137.99
CHEVROLET C10 TRUCK 1967 - 1972, Side Marker Light Bezel	SMB-72CT	\$77.99
FORD F-SERIES TRUCK 1967 - 1979, Tail Light Bezel	TLB-XXFT	\$137.99

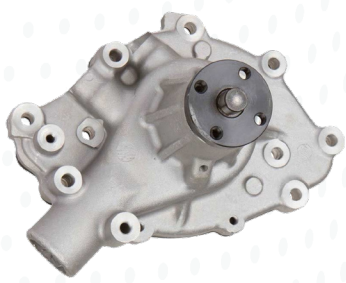

## MARCH ULTRA SERIES WATER PUMPS. PREMIUM COOLING FOR ALL APPLICATIONS.



- »All March Performance Ultra Series water pumps are backed by an industry leading lifetime warranty.
- »High flow pumps designed to keep your ride as cool as possible.
- »Full range of makes and models including GM, Ford, Chrysler, Pontiac and more.
- »100% tested in the USA.



### SMALL BLOCK CHEVY MECHANICAL WATER PUMPS

Standard rotation long water pump. 7" hub height, 5/8" shaft, 1-3/4" inlet. High flow.	Standard rotation short water pump. 5-5/8" hub height, 5/8" shaft, 1-3/4" inlet. High flow.	Reverse rotation short water pump. 5-5/8" hub height, 3/4" shaft, 1.5-1.75" inlet. High flow.	Reverse rotation extra short water pump. 5" hub height, 3/4" shaft, 1". High flow.
<b>CAST</b> P2216 \$98. <sup>95</sup>	<b>CAST</b> P2203 \$71. <sup>95</sup>	<b>CAST</b> P2112 \$79. <sup>95</sup>	<b>CAST</b> P2118 \$79. <sup>95</sup>
<b>BLACK</b> P2216-08 \$108. <sup>95</sup>	<b>BLACK</b> P2203-08 \$108. <sup>95</sup>	<b>BLACK</b> P2112-08 \$99. <sup>95</sup>	<b>BLACK</b> P2118-08 \$99. <sup>95</sup>

### BIG BLOCK CHEVY & LS MECHANICAL WATER PUMPS

BBC standard rotation long water pump. 7-1/4" hub height, 5/8" shaft, 1-3/4" inlet. High flow.	BBC standard rotation short water pump. 5-3/4" hub height, 5/8" shaft, 2" inlet. High flow.	BBC reverse rotation short water pump. 5-3/4" hub height, 5/8" shaft, 2" inlet. High flow.	LS1 counter-clockwise rotation water pump. 6.5" hub height, 3/4" shaft, 11/16" inlet. High flow.
<b>CAST</b> P2126 \$138. <sup>95</sup>	<b>CAST</b> P2131 \$118. <sup>95</sup>	<b>CAST</b> P2125 \$198. <sup>95</sup>	<b>CAST</b> P2116 \$174. <sup>95</sup>
<b>BLACK</b> P2126-08 \$148. <sup>95</sup>	<b>BLACK</b> P2131-08 \$108. <sup>95</sup>	<b>BLACK</b> P2125-08 \$208. <sup>95</sup>	<b>BLACK</b> P2116-08 \$194. <sup>95</sup>



**ADDITIONAL WATER PUMP OPTIONS AVAILABLE AT [MARCHPERFORMANCE.COM](http://MARCHPERFORMANCE.COM)**



## SMALL BLOCK FORD MECHANICAL WATER PUMPS



Standard rotation late water pump. 5-3/4" hub height, 5/8" shaft, 1-3/4" inlet. High flow. Available in cast or black.

CAST	P2162	\$128. <sup>95</sup>
BLACK	P2162-08	\$108. <sup>95</sup>

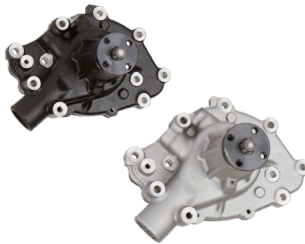

Standard rotation early water pump. 5-7/16" hub height, 5/8" shaft, 1-3/4" inlet. High flow. Available in cast or black.

CAST	P2141	\$108. <sup>95</sup>
BLACK	P2141-08	\$128. <sup>95</sup>

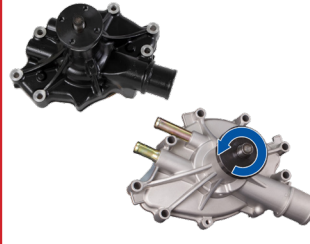

Reverse rotation 5.0L water pump ('79-93). 5-7/8" hub height, 5/8" shaft, 1-3/4" inlet. High flow. Available in cast or black.

CAST	P2173	\$79. <sup>95</sup>
BLACK	P2173-08	\$99. <sup>95</sup>



Standard rotation 351 Cleveland water pump. 5-3/4" hub height, 5/8" shaft, 1-3/4" inlet. High flow. Available in cast or black.

CAST	P2164	\$128. <sup>95</sup>
BLACK	P2164-08	\$138. <sup>95</sup>

## BIG BLOCK FORD | FORD FE



Big Block Ford standard rotation water pump. 5-1/2" hub height, 3/4" shaft, 2" inlet. High flow. Available in cast or black.

CAST	P2158	\$149. <sup>95</sup>
BLACK	P2158-08	\$174. <sup>95</sup>



Ford FE standard rotation water pump. 7-1/2" hub height, 5/8" shaft, 2-1/8" inlet. High flow. Available in cast or black.

CAST	P2184	\$139. <sup>95</sup>
BLACK	P2184-08	\$149. <sup>95</sup>

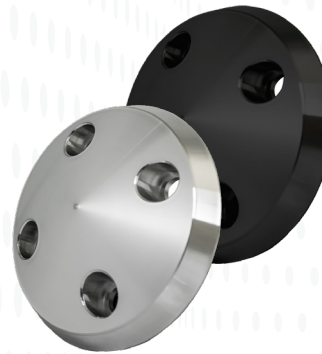

**DECORATIVE PULLEY COVERS. THE FINISHING TOUCH TO ALL PULLEY SYSTEMS.**

COMPLETE YOUR PULLEY KIT WITH DECORATIVE WATER PUMP PULLEY COVERS. AVAILABLE FOR MOST CHEVY & FORD APPLICATIONS.



## ADDITIONAL WATER PUMPS



Pontiac standard rotation water pump. 4-1/2" hub height, 5/8" shaft. High flow.

CAST	P2174	\$98. <sup>95</sup>
BLACK	P2174-08	\$138. <sup>95</sup>



Big Block Chrysler standard rotation water pump. 6-1/2" hub height w/ housing (not included), 5/8" shaft. High flow.

CAST	P2179	\$98. <sup>95</sup>
BLACK	P2179-08	\$119. <sup>95</sup>



Big Block Chrysler water pump (P2179) & housing unit. Standard rotation. 6-1/2" hub height, 5/8" shaft.

CAST	P2177	\$238. <sup>90</sup>
BLACK	P2177-08	\$278. <sup>90</sup>



Standard rotation 351 Cleveland water pump. 5-3/4" hub height, 5/8" shaft, 1-3/4" inlet. High flow.

CAST	P2164	\$128. <sup>95</sup>
BLACK	P2164-08	\$138. <sup>95</sup>

**MARCH ULTRA ACCESSORIES ARE BACKED BY OUR INDUSTRY LEADING LIFETIME WARRANTY.**





## BUILD YOUR OWN -AN KIT

- M -AN FITTINGS
- M -AN LINES
- M -AN ADAPTERS

AVAILABLE IN POLISHED & BLACK FINISHES



**M BRAIDED HOSES**  
Durable braided black or stainless hose. Sold in 3 foot sections for -16 or -20AN.  
xxAN3FT \$75



**M 45° FITTINGS**  
45° -AN fitting. Available in black or polished finishes. For -16 and -20AN.  
HE-AN20-45 \$25-50



**M 90° FITTINGS**  
90° -AN fitting. Available in black or polished finishes. For -16 and -20AN.  
HE-AN20-90 \$25-50



**M STRAIGHT FITTINGS**  
Straight -AN fitting. Available in black or polished finishes. For -16 and -20AN.  
HE-AN20-ST \$20-30



**M 60° FITTINGS**  
60° -AN fitting. Available in black or polished finishes. For -16 and -20AN.  
HE-AN20-60 \$25-50

### -AN FITTINGS SKU GUIDE

HE - AN X - X - X

- |                     |          |          |                 |
|---------------------|----------|----------|-----------------|
| <b>1</b> SIZE       | <b>1</b> | <b>2</b> | <b>3</b>        |
| 16 -16 AN           |          |          |                 |
| 20 -20 AN           |          |          |                 |
| <b>2</b> ANGLE      |          |          | <b>3</b> FINISH |
| ST Straight fitting |          |          | 04 Polished     |
| 45 45° fitting      |          |          | 08 Black        |
| 60 60° fitting      |          |          |                 |
| 90 90° fitting      |          |          |                 |

## THERMOSTAT HOUSINGS

**M STRAIGHT**



**M 15 DEGREE**



**M 45 DEGREE**



**M 95 DEGREE**



**M -AN HOUSINGS**



Convert your thermostat housing directly to -16 or -20 AN. Includes mounting hardware, o-ring, and gasket.

### THERMOSTAT HOUSINGS AVAILABLE FOR:

- Chevy LS
- Chevy Small Block
- Chevy Big Block
- Chrysler Small Block
- Chrysler Big Block
- Ford Straight Six
- Ford FE
- Ford Small Block
- Ford Big Block
- Pontiac 326-455



**360°**

**360° SWIVEL FOR PERFECT FIT AND ROUTING**



## ULTRA SERIES AC COMPRESSORS



Sanden 7176/SD-7 AC compressor. Available in 8 or 6-groove serpentine. Pre oiled. For use with R134a refrigerant.

**P2412-06**

**\$278.<sup>95</sup>**



Sanden 508 AC compressor. 6-groove serpentine clutch assembly. Pre oiled. For use with R134a refrigerant.

**P2413-06**

**\$278.<sup>95</sup>**



Sanden 508 AC compressor. 2V v-belt clutch assembly. Pre oiled. For use with R134a refrigerant.

**P2415-06**

**\$259.<sup>95</sup>**



## AVAILABLE IN OUR 4 POPULAR FINISHES

CAST	POLISHED	BLACK	CHROME

We back all of our accessories, AC Compressors included, with a lifetime warranty. If you need assistance in selecting the right AC Compressor for your build, or have any other questions, give our sales staff a call at **(888) 729-9070** or send us an email to [info@marchperformance.com](mailto:info@marchperformance.com).

## OFFICIAL VINTAGE AIR™ PROVIDER



Vintage Air  
**SureFit™**  
Systems

Keep your ride cool and drive it more often with a new AC system from Vintage Air™. March Performance is proud to be a distributor and partner with an industry leader who cares about quality and performance.

Vintage Air™ is the pioneer in classic AC systems and their Surefit™ systems are the gold standard. Each Gen V Magnum™ system features fully electronic operation (No cables or vacuum controls!). This simplifies installation and gives you infinite control of your air blend. Variable speed blower motors also let you control air speed. Patented cable converters let you re-use your factory controls for an OEM look

Order online or call us at (888) 729-9070 and we can walk you through the selection process to make sure your AC system will work well with your pulleys and brackets. We carry the full line of Vintage Air™ products to help you stay cool!

### SUREFIT™ SYSTEMS AVAILABLE FOR:

- 1964 - 70; 87 - 93 Mustang
- 1966 - 79 Bronco
- 1953 - 56; '61-86 Ford F-Series Truck
- 1970 - 72; '82-88 Monte Carlo
- 1958 - 82 Corvette
- 1967 - 92 Camaro
- 1964 - 72; '82-88 Chevelle & El Camino
- 1959 - 66 Impala
- 1947 - 94 Chevy Truck
- 1955 - 57 Chevrolet
- 1962 - 74 Nova
- 1964 - 72 GTO
- 1967 - 92 Firebird
- 1970 - 74 Barracuda & Challenger
- 1966 - 70 Charger, Super Bee & Coronet
- 1966 - 70 Road Runner
- 1968 - 72; '82-88 Cutlass
- 1968 - 83 Toyota Land Cruiser

Please call for application questions.

\*Vintage Air™ Systems are NOT included in March's lifetime warranty, but is backed by Vintage Air™ for 1 year.

# MARCH

**MARCH PERFORMANCE**  
620 6th Street NW  
New Prague, MN 56071

PRSR STD  
U.S. POSTAGE  
PAID  
MARCH PERF.

## 6 REASONS TO CHOOSE MARCH PERFORMANCE



### **KNOWLEDGE & EXPERIENCE**

*Our 28 years experience in automotive performance products helps you get the right parts the first time.*



### **NO POLISHING NEEDED**

*All brackets and pulleys have clear powder coatings that eliminate polishing in those hard to reach places.*



### **ALL BILLET PRODUCTS**

*Made of 6061-T6 aircraft grade aluminum. Our brackets are 100% thicker than similar products and far superior than cast brackets.*



### **PRECISION CNC MACHINED**

*Built to run perfectly true from our countless years of aircraft & automotive manufacturing experience.*



### **EXCEPTIONAL STYLING**

*Kits are developed with superior styling in mind. It shows through where it's important: when installed in your car's engine bay.*



### **HARD COATING**

*Hard coating increase pulley life. Hardened to 65 Rockwel "C" scale. Harder than steel, 2 times harder than forged aluminum!*

# MARCH PERFORMANCE

**MARCHPERFORMANCE.COM**



**LIFETIME WARRANTY**

**DESIGN. PRECISION. STYLE.**

**FREE TECHNICAL SUPPORT**  
**MONDAY - FRIDAY 9AM - 6PM (EST)**

**1.888.729.9070**

**INFO@MARCHPERFORMANCE.COM**

COPYRIGHT MARCH PERFORMANCE INC. // 2025 // ALL RIGHTS RESERVED