

# **dnd**

**opening  
your projects**





sistemi di chiusura  
*locking systems*

**vertical  
dynamic**

2

18

Dnd technical division

maniglia  
*handle*

**interna**

26

Giulio Iacchetti

# vertical

sistema di chiusura  
con serratura invisibile

*locking system  
with invisible lock*



# la serratura del futuro è invisibile

*the lock of the future is invisible*



**Innovazione, design e funzionalità** si integrano grazie a una tecnologia avanzata, a materiali di qualità e a una progettazione attenta a ogni dettaglio.

Vertical è il **sistema di chiusura con serratura invisibile** per porta a battente: consente una perfetta apertura e chiusura dell'anta, assicura prestazioni sul lungo periodo, ha un valore estetico che incontra le tendenze dell'interior design contemporaneo.

Con il sistema Vertical, Dnd fornisce un **kit porta completo e coordinato** con tutte le maniglie di design a catalogo.

**Innovation, design and functionality** are combined thanks to advanced technology, quality materials and a design that pays attention to every detail.

Vertical is the **locking system with an invisible lock** for hinged doors: it allows perfect opening and closing of the door, ensures long-term performance, has an aesthetic value that meets the trends contemporary interior design trends.

With the Vertical system, Dnd provides a **complete and coordinated door kit** with all the design handles in the catalogue.

**unica**

**unique**







# flessibile

flexible



La cassa della serratura è realizzata in POM, un materiale plastico autolubrificante di colore nero, riciclabile e dalle **alte prestazioni**.

La cover della serratura e dell'incontro sono di **ottone**, disponibili nelle diverse finiture delle maniglie Dnd, così da formare un insieme dal **tono uniforme**.

L'aggancio a clip della cover permette di nascondere le viti per ottenere una **pulizia formale** che viene, inoltre, esaltata dallo scrocco magnetico di colore nero.

La riduzione e la **semplicità dei componenti interni** permettono di affinare le prestazioni della serratura.

*The lock case is made of POM, a black, recyclable and **high-performance** self-lubricating plastic material.*

*The lock and striking plate covers are made of **brass**, available in the different finishes of the Dnd handles, so as to form a set with a **harmonious tone**.*

*The clip fastening of the cover makes it possible to conceal the screws to achieve a **formal neatness** which is also enhanced by the black magnetic latch.*

*The reduction and **simplicity of the internal components** make it possible to improve the performance of the lock.*



# **coordinata**

**coordinated**





## **innovazione** *innovation*

Semplificazione dei componenti del prodotto e nuovi materiali riciclabili.  
*Simplification of product components and new recyclable materials.*

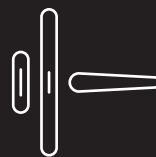

## **design** *design*

Design minimale in linea con le maniglie Dnd.  
*Minimal design consistent with Dnd handles.*



## **qualità** *quality*

Funzionalità garantita e brevettata.  
*Guaranteed and patented functionality.*



## **tutte le finiture** *all finishes*

Possibilità di scelta tra tutte le finiture a catalogo.  
*Possibility to choose from all the finishes in the catalogue.*



## **magnetica** *magnetic*

Per una perfetta apertura e chiusura dell'anta.  
*For a perfect door opening and closing.*



## **resistenza** *endurance*

Resistenza e qualità assicurate da cicli certificati.  
*Endurance and quality ensured by certified cycles.*



Progettata per far scomparire completamente le viti sul frontale della porta, **Vertical garantisce armonia tra maniglia e serratura** e sa adattarsi a ogni stile, grazie all'ampia gamma di finiture delle cover.

*Designed to completely conceal screws on the door's front. **Vertical ensures harmony between the handle and lock** and can adapt to any style, thanks to the wide range of cover finishes.*



guarda il video di **Vertical**

*watch the video of **Vertical***



# la rivoluzione del concetto di chiusura

*the revolution of door locking concept*

## Cover incontro

In ottone, nella stessa finitura delle maniglie

## Striking plate cover

In brass, with the same finish as the handles



## Incontro

Cassa in POM

## Striking plate

POM case

## Cover serratura

In ottone, nella stessa finitura delle maniglie

## Lock cover

In brass, with the same finish as the handles

## Serratura

Con cassa in POM e inserti metallici a L

## Lock

With POM case and L metal inserts



## Adattatore

Per variante nottolino

## Adaptor

For turn and release version



patent pending



made in italy

Vertical è il sistema di chiusura che ridefinisce il concetto di eleganza e funzionalità applicato alla serratura. Le performance sono garantite dall'**eccellenza dei materiali** impiegati e dai rigidi test ai quali viene sottoposto il sistema.

*Vertical is the locking system that redefines the concept of elegance and functionality. Performance is guaranteed by the **excellence of the materials** and by the rigorous testing the system is subjected.*

# uno stile unico

*a unique style*



**ONO**

Nero  
Black



**PGS**  
**forte®**

Grafite satinato  
Satin graphite

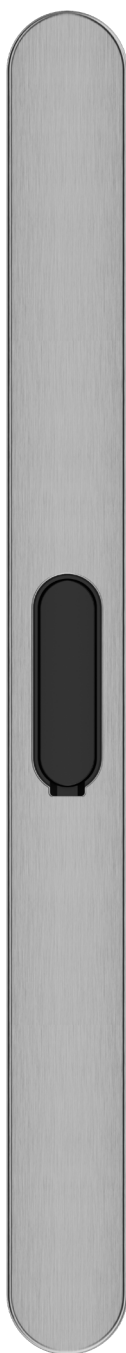

**OCS**

Cromo satinato  
Satin chrome

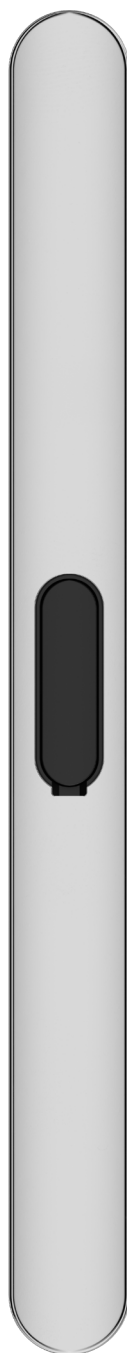

**OC**

Cromo lucido  
Polished chrome



**OBN**

Bianco  
White

Il sistema Vertical è disponibile **in tutte le finiture della gamma Dnd**. Estetica e personalizzazione sono garantite dall'ampia gamma di finiture che permettono di scegliere il sistema Vertical in base alle caratteristiche formali e cromatiche della porta.

*The Vertical system is available **in all the Dnd finishes**. Aesthetics and customisation are guaranteed by the wide range of finishes that allow the Vertical system to be chosen according to the formal and chromatic features of the door.*

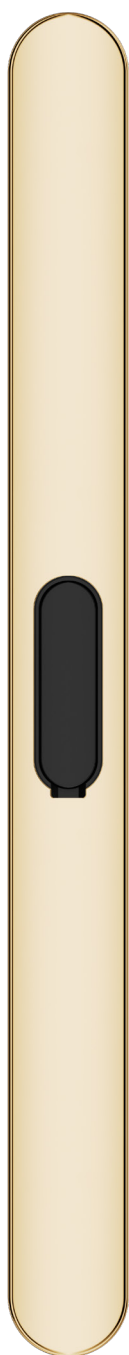

**PVD-BG**  
**forte®**  
Oro antico  
lucido  
*Antique bright  
gold*

**PVD-SG**  
**forte®**  
Oro antico  
satinato  
*Antique satin  
gold*

**BSO**  
Bronzo  
sabbaiato opaco  
*Matt sandblasted  
bronze*

**OGH**  
Bronzo  
satinato opaco  
*Matt satin  
bronze*

**ABC**  
Blu colomba  
*Blue dove*

# la serratura tradizionale incontra il design

*traditional lock meets design*

Vertical è disponibile con  
**nottolino**, con **pomolo per  
cilindro**, con bocchette foro  
Yale o **senza bocchette**.

*Vertical is available  
with **turn and release**,  
with a **knob for the cylinder**,  
with **Yale hole** escutcheons  
or **without escutcheons**.*

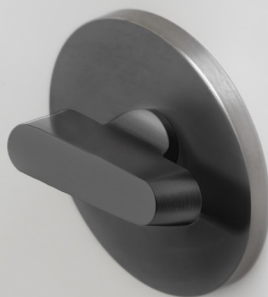
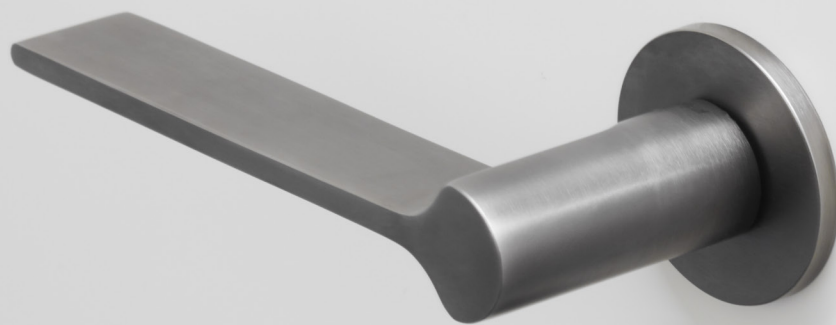

**Sistema Vertical con nottolino**  
*Vertical system with turn and release*

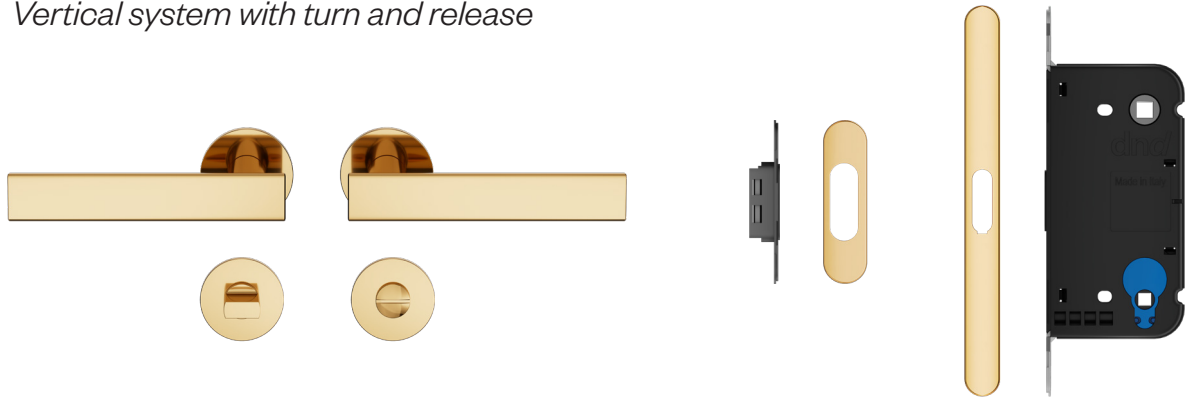

**Sistema Vertical con pomolo per cilindro**  
*Vertical system with knob for cylinder*

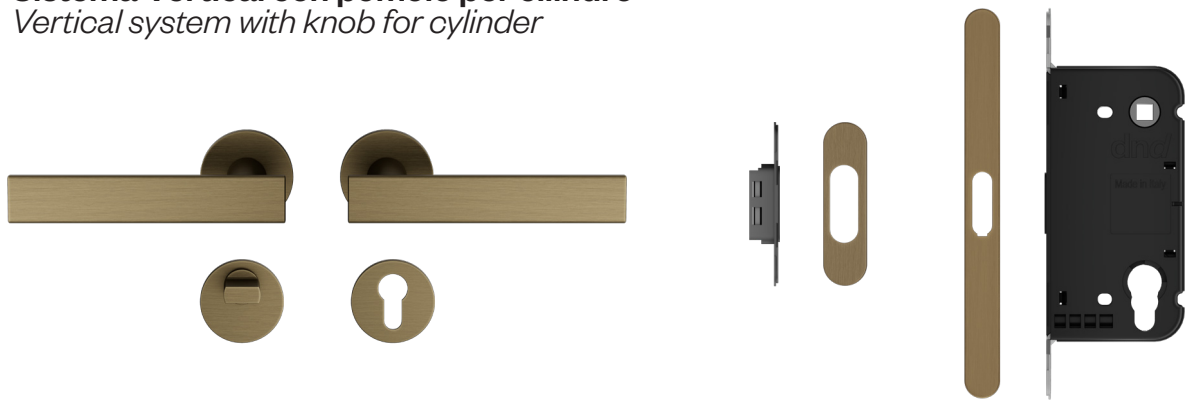

**Sistema Vertical con bocchette foro Yale**  
*Vertical system with Yale hole escutcheons*

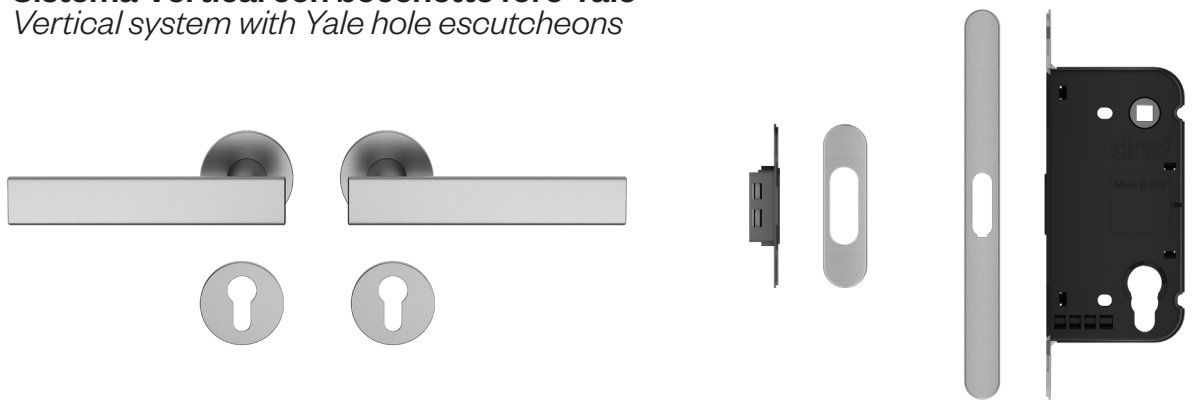

**Sistema Vertical senza bocchette**  
*Vertical system without escutcheons*

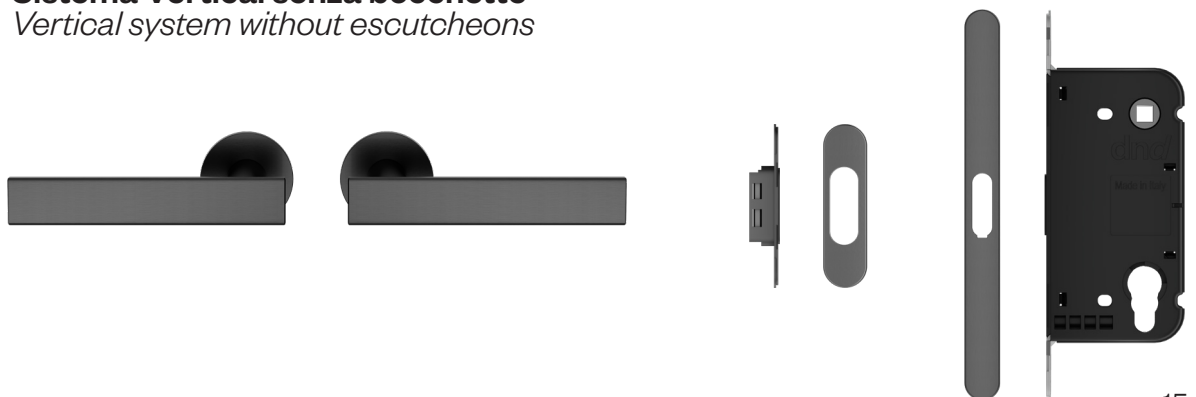





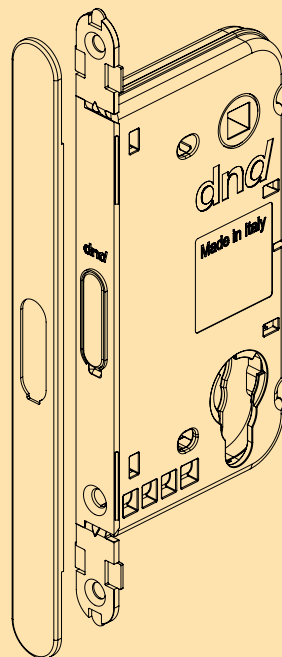
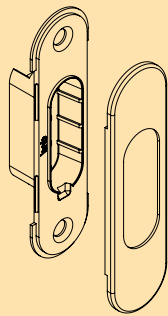
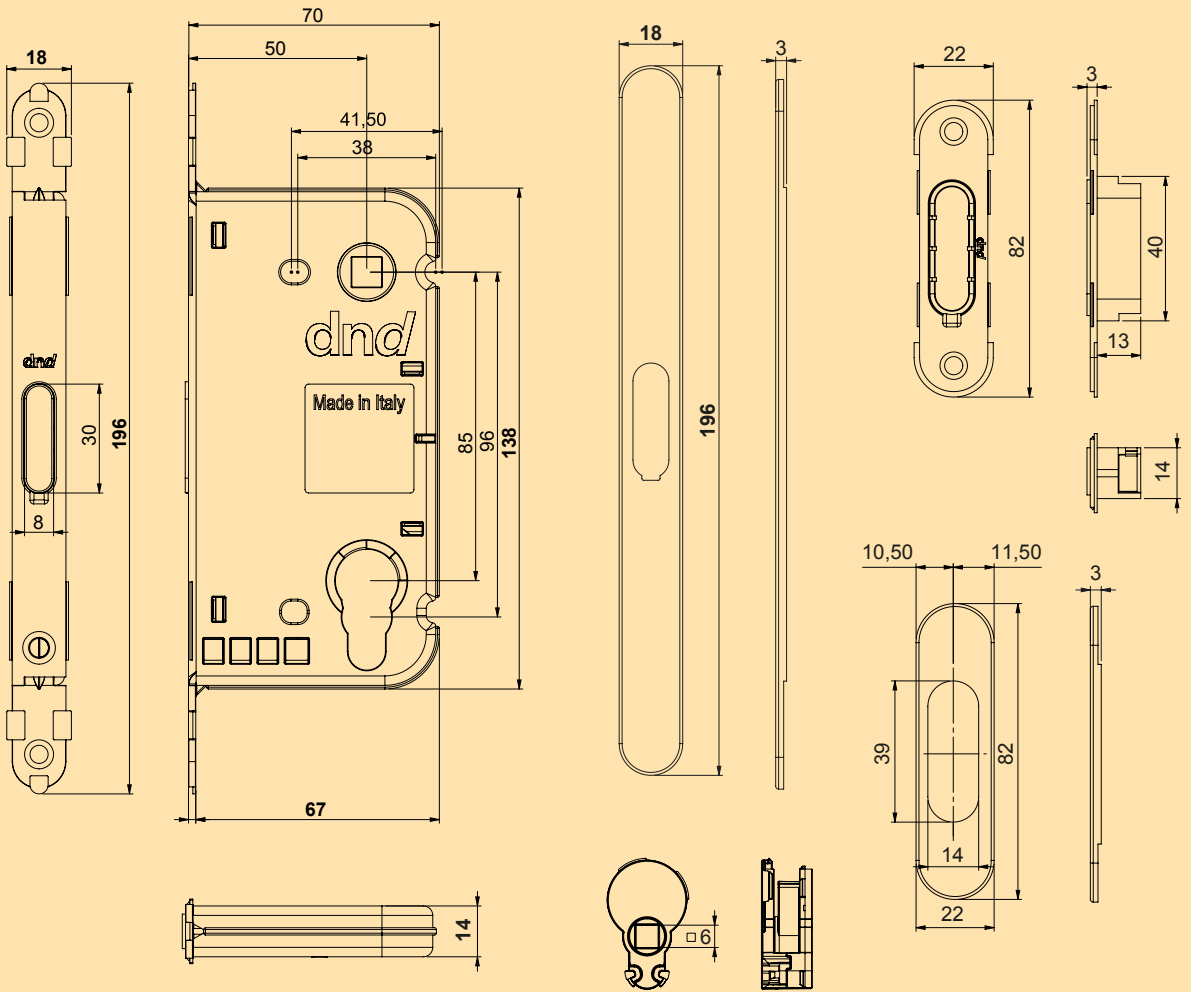

# vertical

dimensioni in millimetri  
dimensions in millimetres



-  cilindro / cylinder
-  nottolino / turn and release
-  cilindro codolo / knob for cylinder
-  50 entrata 50mm / backset 50mm

# dynamic

sistema di chiusura  
con magnete

*magnet locking  
system*



# la semplicità nell'aprire e nel chiudere

*opening and closing made easy*

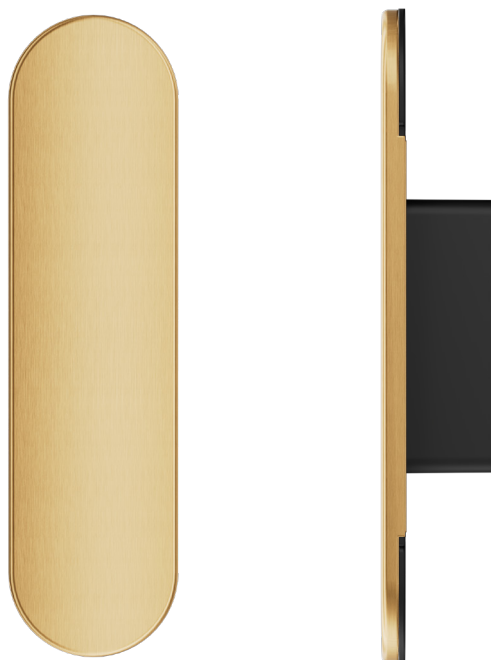

Dynamic è un sistema di chiusura per porte a battente, senza bloccaggio, che integra un **supporto magnetico di attrazione**: grazie a esso, la porta o il pannello non hanno più bisogno di un corpo serratura. Le azioni dell'aprire e del chiudere si fanno, così, **semplici e intuitive**.

Nella concezione contemporanea della porta come complemento d'arredo, oltre che come classico separatore tra ambienti e spazi, Dynamic **agevola il gesto di relazione con l'anta** e valorizza al massimo le esigenze della progettazione e i **desideri di personalizzazione**. L'integrazione del sistema Dynamic nel disegno della porta e degli ambienti domestici lascia grande spazio alla creatività dell'interior designer.

*Dynamic is a locking system for hinged doors with an **integrated magnetic surface** and no physical lock: as a result, doors and panels no longer require a lock body. The opening and closing actions have been **made simple and intuitive**.*

*In keeping with the contemporary notion of a door as both a furnishing accessory and a traditional way to separate rooms and spaces, Dynamic **facilitates the act of relating to the door** and makes the most of the design needs and **customisation desires**. By integrating the Dynamic system into the design of the door and home environments, ample space is left for interior designer creativity.*



# la forza dell'attrazione magnetica

## *the force of magnetic attraction*

Il sistema Dynamic è composto da una base che accoglie il **magnete**, da una cover di ottone e da un supporto di polo opposto che attrae e blocca l'anta. La ritenuta dell'anta si attiva tramite la sola forza magnetica, **senza viti a vista** e senza lo stretto contatto tra elementi che è necessario nello scrocco tradizionale.

I poli magnetici del sistema possono essere fissati alla porta sia nella classica posizione sullo stipite – in verticale – sia nel traverso superiore del telaio, dunque in posizione orizzontale. Inoltre, le cover di Dynamic sono **realizzabili in tutte le finiture** del catalogo Dnd.

*The Dynamic system comprises a **magnet-housing base**, a brass cover and an opposite pole support that attracts and locks the door. The door lock is activated by magnetic force alone, with **no visible screws** or the close contact of elements needed for a traditional latch.*

*The system's magnetic poles can be fixed to the door either in the classic position on the jamb – vertically – or on the upper crosspiece of the frame, i.e. horizontally. Furthermore, the Dynamic covers are available in **all the finishes** offered in the Dnd catalogue.*

### **Cover Cover**

In ottone, nella stessa finitura della maniglia  
*In brass with the same finish as the handle*

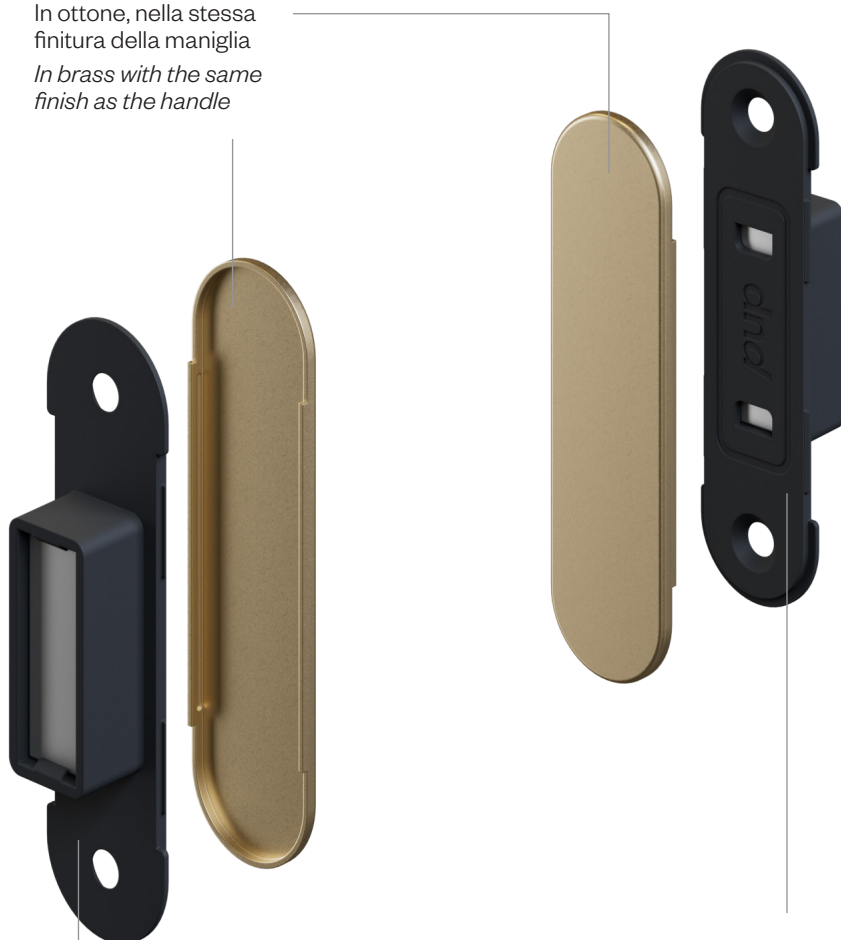

### **Supporto magnetico Magnetic holder**

Cassa in POM con elementi magnetici  
*POM body with magnetic elements*





# tecnologia e versatilità

*technology and versatility*



## **Posizionamento**

Il sistema può essere fissato alla porta sia in verticale sia in orizzontale

## **Positioning**

*The system can be mounted on the door either vertically or horizontally*

# design e qualità

*design and quality*



## Ritenuta magnetica della porta

*Magnetic retention of the door*

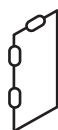

## Flessibilità nel posizionamento

*Position flexibility*



## Senza viti a vista

*No visible screws*

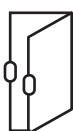

## Apertura semplice e intuitiva

*Simple and intuitive opening*



## Coerenza estetica tra gli elementi

*Aesthetic consistency among the elements*



## Disponibile in tutte le finiture a catalogo

*Available in all finishes of the catalogue*

**dimensioni in millimetri**  
*dimensions in millimetres*

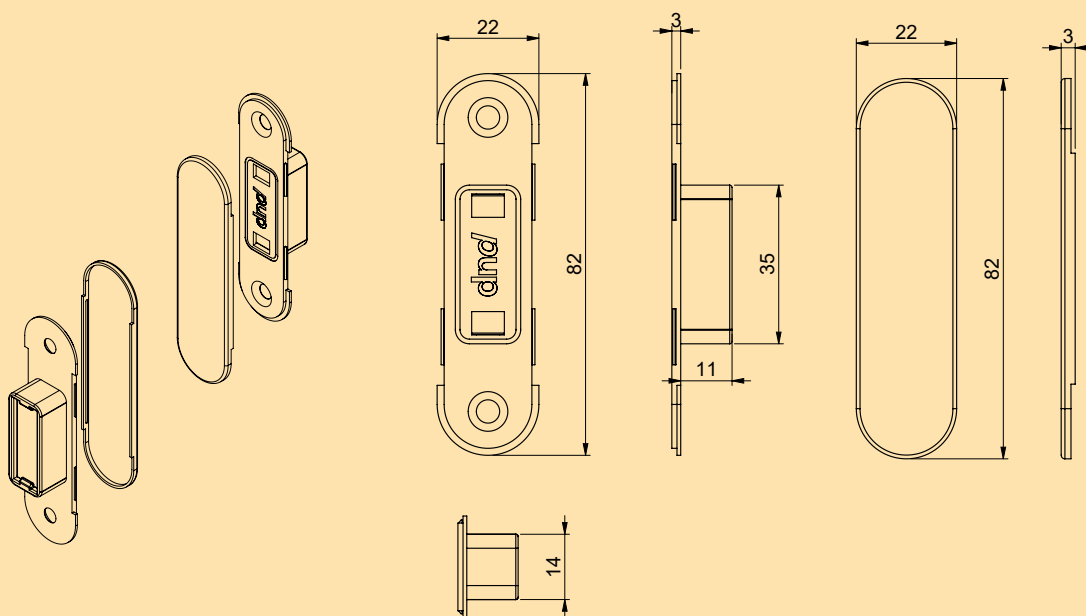



**PVD-BG forte\***  
Oro antico  
lucido  
*Antique  
bright gold*



**PVD-SG forte\***  
Oro antico  
satinato  
*Antique  
satin gold*



**PVD-SH forte\***  
Oro champagne  
satinato  
*Champagne  
satin gold*



**PVD-BB forte\***  
Bronzo lucido  
*Bright bronze*



**PVD-SB forte\***  
Bronzo satinato  
*Satin bronze*



**PGS forte\***  
Grafite satinato  
*Satin graphite*



**OGH**  
Bronzo satinato  
opaco  
*Matt satin  
bronze*



**OCS**  
Cromo satinato  
*Satin chrome*



**OC**  
Cromo lucido  
*Polished chrome*



**ONO**  
Nero  
*Black*



**OBN**  
Bianco  
*White*



**OSV**  
Silver  
*Silver*



**OBT**  
Turchese  
*Turquoise*



**OBC**  
Blu colomba  
*Blue dove*



**OVP**  
Violetto pastello  
*Pastel violet*



**OGO**  
Giallo oliva  
*Yellow olive*



**OBR**  
Bronzo  
*Bronze*



**ORA**  
Oro satinato  
*Satin gold*

# interna

Una maniglia per un gesto  
nuovo e intuitivo

*A handle for a new, intuitive  
gesture*



# l'immediatezza svincolata dalla meccanica

*immediacy released from mechanics*

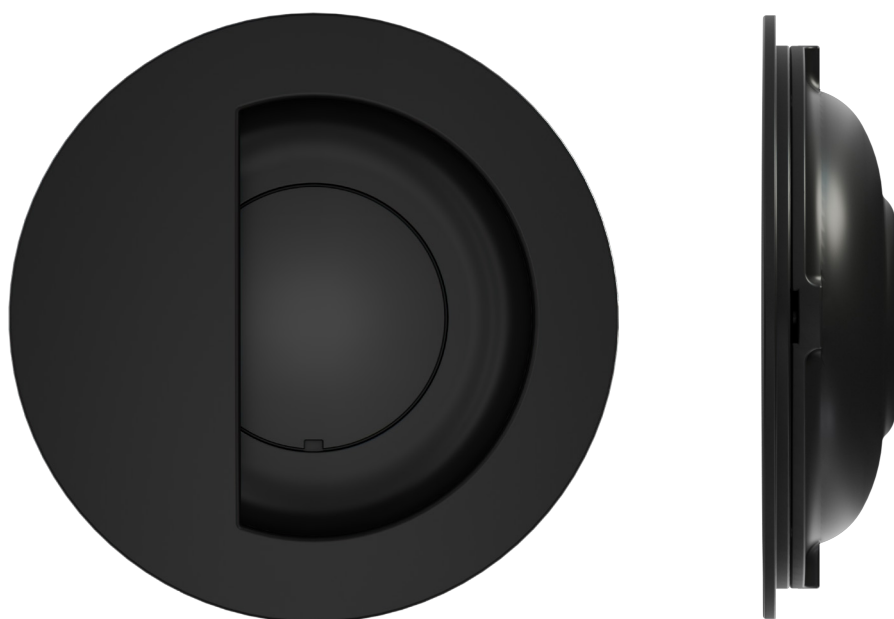

design:  
**Giulio lacchetti**

Interna è una maniglia che nasce unitamente al nuovo sistema Dynamic: si tratta di **un oggetto dal design minimale e dal profilo circolare**, pensato per essere inserito nel pannello della porta e accogliere la mano all'interno di una pratica e accogliente concavità smussata.

Interna segna una svolta nel catalogo Dnd: è una presa che non implica un movimento, in quanto non è legata al tradizionale apparato meccanico della porta. **Interna non ingombra e non sporge dalla superficie del pannello.** È realizzata in zama ed è disponibile in nove diverse finiture, per soddisfare al meglio i desideri della progettazione a livello cromatico.

*Interna is a handle that was created alongside the new Dynamic system: **it boasts a minimal design, circular profile** and has been designed to be inset into the door panel to provide a practical and welcoming bevelled concave for your hand.*

*Interna marks a turning point in the Dnd product range: its grip does not imply movement as it is not linked to the door's traditional mechanical device. **Interna is compact and sits flush with the surface of the panel.** It is made of zamak and available in nine different finishes to best satisfy the designer's whims in terms of colour.*







# interna

design:  
**Giulio lacchetti**

made in Italy



Interna genera un **gesto nuovo** e intuitivo di relazione con la porta, grazie alla sua facilità di lettura: è un **segno geometrico semplice**, senza complicazioni formali, che invita con immediatezza alla presa, all'apertura e alla chiusura.

*Interna creates a new, **intuitive relationship** with the door, thanks to its user-friendliness: the **simple geometric shape** with no overly complicated elements makes grasping, opening and closing much more inviting.*

# finiture *finishes*

zama zamak

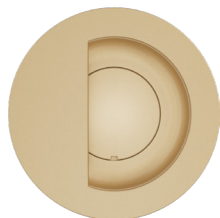

**ZRA**  
Oro  
*gold*



**ZBR**  
Bronzo  
*Bronze*

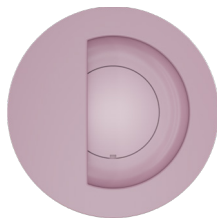

**ZVP**  
Violetto pastello  
*Pastel violet*

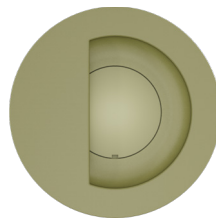

**ZGO**  
Giallo oliva  
*Yellow olive*

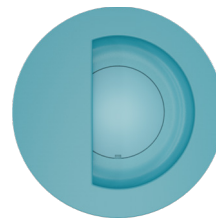

**ZBT**  
Turchese  
*Turquoise*

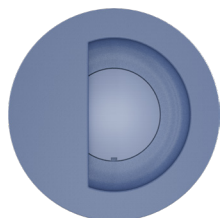

**ZBC**  
Blu colomba  
*Blue dove*



**ZSV**  
Silver  
*Silver*



**ZBN**  
Bianco  
*White*



**ZNE**  
Nero  
*Black*

## dimensioni in millimetri *dimensions in millimetres*

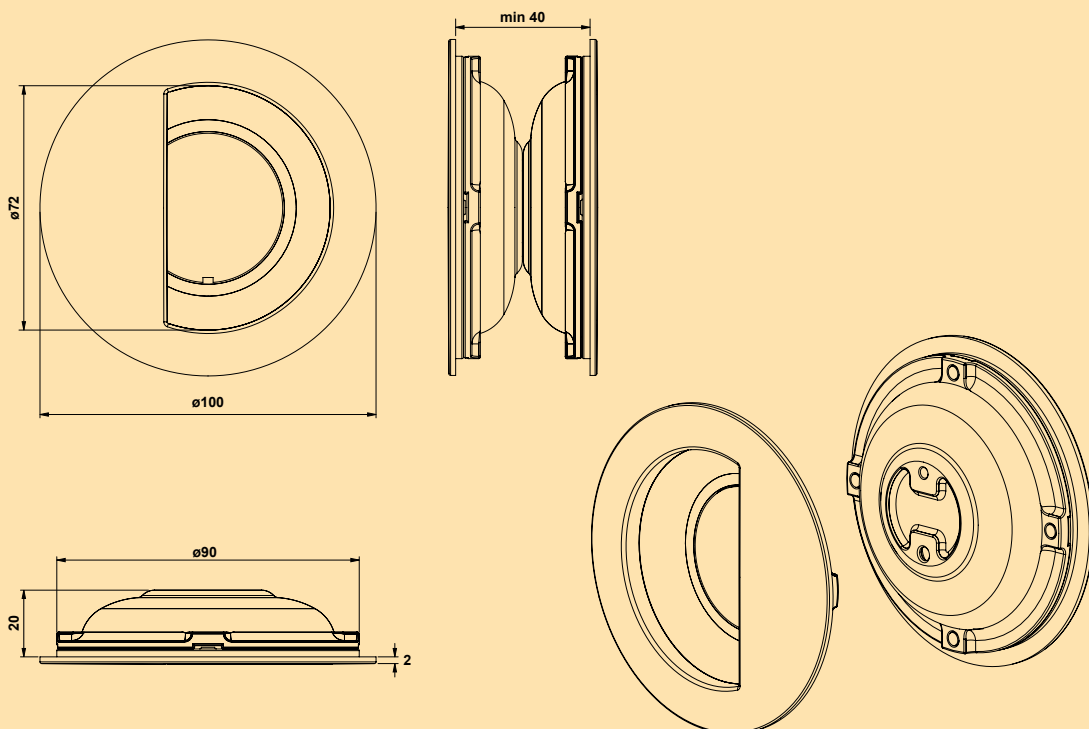

Progetto grafico /  
*Graphic design*  
**Lorenzo De Bon**  
**Irene Sartor**  
- Webkolm -

Fotografie /  
*Photographs*  
**Tiziano Reguzzi**

Render 3D /  
*Render 3D*  
**Michele Faccoli**

Stampa /  
*Printing*  
**Tipolitografia Pagani**

# dnd

**Dnd Martinelli S.r.l.**  
Via Piani di Mura, 2  
25070 Casto (BS) - Italia

T +39 0365 899113  
info@dndhandles.it

**www.dndhandles.it**



© 2024 Dnd Martinelli S.r.l.

Tutti i diritti riservati  
*All rights reserved*

# dnd

handles  
with care

dndhandles.it  
made in italy



Versione digitale  
della brochure

*Digital version  
of the brochure*