

dnd

**opening
your projects**



sistemi di chiusura
locking systems

**vertical
dynamic**

2

18

Dnd technical division

maniglia
handle

interna

26

Giulio Iacchetti

vertical

sistema di chiusura
con serratura invisibile

*locking system
with invisible lock*

la serratura del futuro è invisibile

the lock of the future is invisible



Innovazione, design e funzionalità si integrano grazie a una tecnologia avanzata, a materiali di qualità e a una progettazione attenta a ogni dettaglio.

Vertical è il **sistema di chiusura con serratura invisibile** per porta a battente: consente una perfetta apertura e chiusura dell'anta, assicura prestazioni sul lungo periodo, ha un valore estetico che incontra le tendenze dell'interior design contemporaneo.

Con il sistema Vertical, Dnd fornisce un **kit porta completo e coordinato** con tutte le maniglie di design a catalogo.

Innovation, design and functionality are combined thanks to advanced technology, quality materials and a design that pays attention to every detail.

Vertical is the **locking system with an invisible lock** for hinged doors: it allows perfect opening and closing of the door, ensures long-term performance, has an aesthetic value that meets the trends contemporary interior design trends.

With the Vertical system, Dnd provides a **complete and coordinated door kit** with all the design handles in the catalogue.

unica

unique







flessibile

flexible



La cassa della serratura è realizzata in POM, un materiale plastico autolubrificante di colore nero, riciclabile e dalle **alte prestazioni**.

La cover della serratura e dell'incontro sono di **ottone**, disponibili nelle diverse finiture delle maniglie Dnd, così da formare un insieme dal **tono uniforme**.

L'aggancio a clip della cover permette di nascondere le viti per ottenere una **pulizia formale** che viene, inoltre, esaltata dallo scrocco magnetico di colore nero.

La riduzione e la **semplicità dei componenti interni** permettono di affinare le prestazioni della serratura.

*The lock case is made of POM, a black, recyclable and **high-performance** self-lubricating plastic material.*

*The lock and striking plate covers are made of **brass**, available in the different finishes of the Dnd handles, so as to form a set with a **harmonious tone**.*

*The clip fastening of the cover makes it possible to conceal the screws to achieve a **formal neatness** which is also enhanced by the black magnetic latch.*

*The reduction and **simplicity of the internal components** make it possible to improve the performance of the lock.*

coordinata

coordinated





innovazione *innovation*

Semplificazione dei componenti del prodotto e nuovi materiali riciclabili.
Simplification of product components and new recyclable materials.

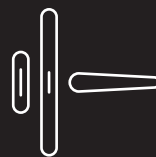

design *design*

Design minimale in linea con le maniglie Dnd.
Minimal design consistent with Dnd handles.



qualità *quality*

Funzionalità garantita e brevettata.
Guaranteed and patented functionality.



tutte le finiture *all finishes*

Possibilità di scelta tra tutte le finiture a catalogo.
Possibility to choose from all the finishes in the catalogue.



magnetica *magnetic*

Per una perfetta apertura e chiusura dell'anta.
For a perfect door opening and closing.



resistenza *endurance*

Resistenza e qualità assicurate da cicli certificati.
Endurance and quality ensured by certified cycles.



Progettata per far scomparire completamente le viti sul frontale della porta, **Vertical garantisce armonia tra maniglia e serratura** e sa adattarsi a ogni stile, grazie all'ampia gamma di finiture delle cover.

*Designed to completely conceal screws on the door's front. **Vertical ensures harmony between the handle and lock** and can adapt to any style, thanks to the wide range of cover finishes.*



guarda il video di **Vertical**

*watch the video of **Vertical***

la rivoluzione del concetto di chiusura

the revolution of door locking concept

Cover incontro

In ottone, nella stessa finitura delle maniglie

Striking plate cover

In brass, with the same finish as the handles



Incontro

Cassa in POM

Striking plate

POM case

Cover serratura

In ottone, nella stessa finitura delle maniglie

Lock cover

In brass, with the same finish as the handles

Serratura

Con cassa in POM e inserti metallici a L

Lock

With POM case and L metal inserts

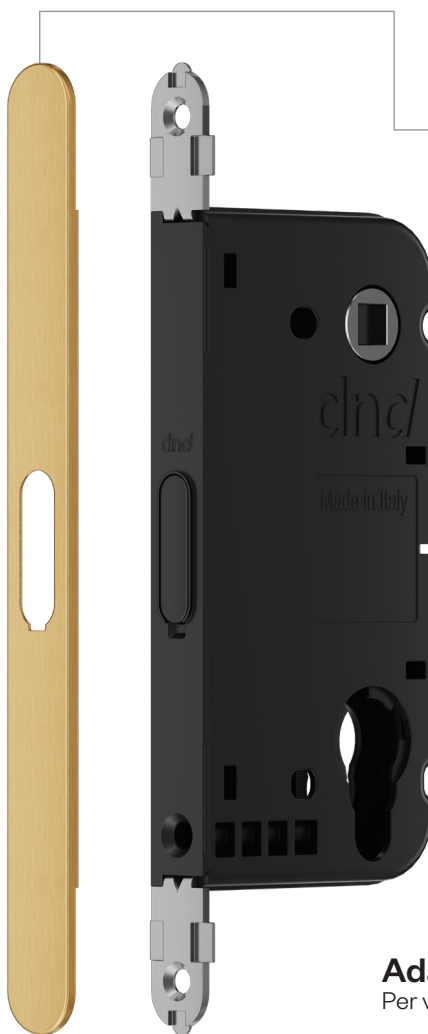

Adattatore

Per variante nottolino

Adaptor

For turn and release version



patent pending



made in italy

Vertical è il sistema di chiusura che ridefinisce il concetto di eleganza e funzionalità applicato alla serratura. Le performance sono garantite dall'**eccellenza dei materiali** impiegati e dai rigidi test ai quali viene sottoposto il sistema.

*Vertical is the locking system that redefines the concept of elegance and functionality. Performance is guaranteed by the **excellence of the materials** and by the rigorous testing the system is subjected.*

uno stile unico

a unique style



ONO

Nero
Black



**PGS
forte®**

Grafite satinato
Satin graphite

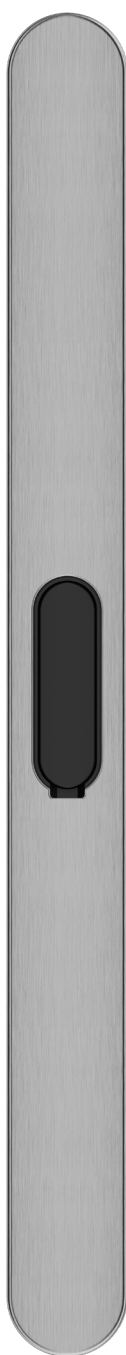

OCS

Cromo satinato
Satin chrome



OC

Cromo lucido
Polished chrome



OBN

Bianco
White

Il sistema Vertical è disponibile **in tutte le finiture della gamma Dnd**. Estetica e personalizzazione sono garantite dall'ampia gamma di finiture che permettono di scegliere il sistema Vertical in base alle caratteristiche formali e cromatiche della porta.

*The Vertical system is available **in all the Dnd finishes**. Aesthetics and customisation are guaranteed by the wide range of finishes that allow the Vertical system to be chosen according to the formal and chromatic features of the door.*

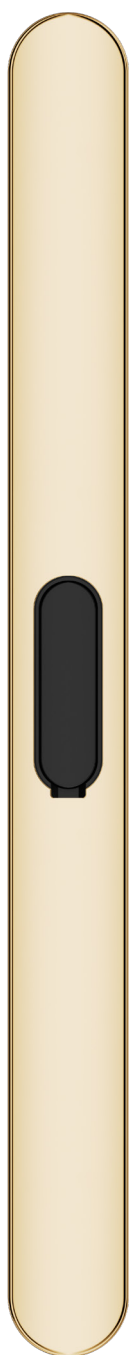

PVD-BG
forte®
Oro antico
lucido
*Antique bright
gold*



PVD-SG
forte®
Oro antico
satinato
*Antique satin
gold*



BSO
Bronzo
sabbaiato opaco
*Matt sandblasted
bronze*



OGH
Bronzo
satinato opaco
*Matt satin
bronze*



ABC
Blu colomba
Blue dove

la serratura tradizionale incontra il design

traditional lock meets design

Vertical è disponibile con
nottolino, con **pomolo per
cilindro**, con bocchette foro
Yale o **senza bocchette**.

*Vertical is available
with **turn and release**,
with a **knob for the cylinder**,
with **Yale hole** escutcheons
or **without escutcheons**.*

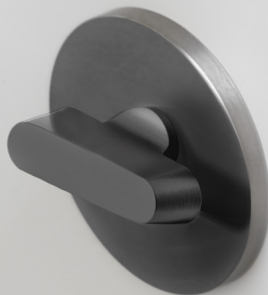
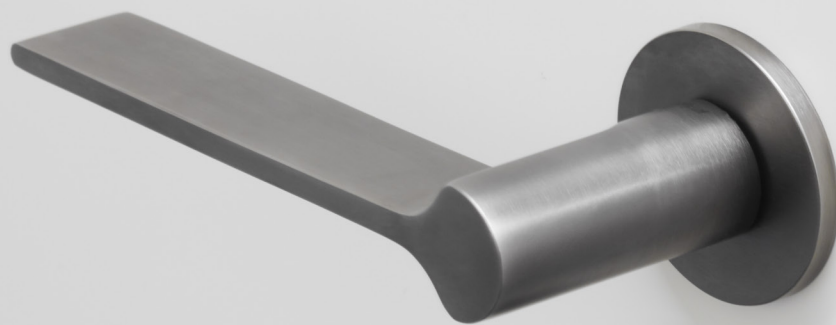

Sistema Vertical con nottolino
Vertical system with turn and release

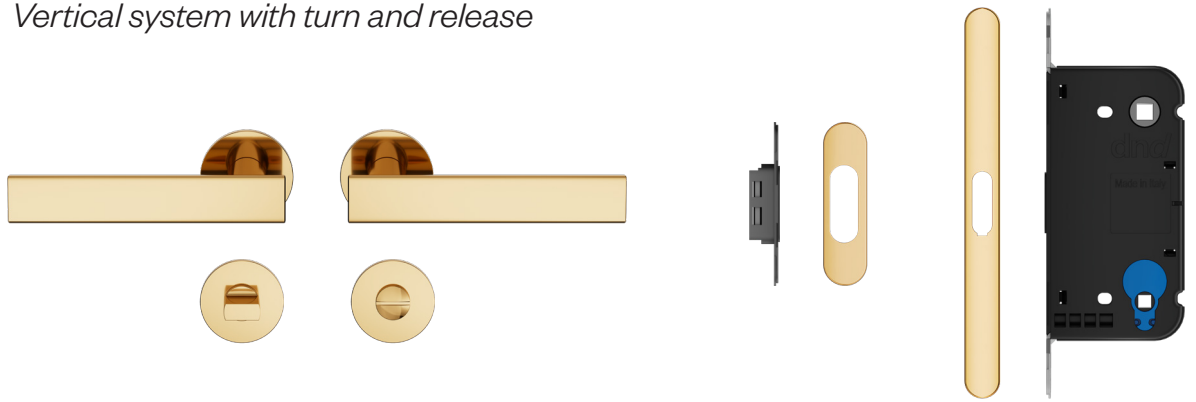

Sistema Vertical con pomolo per cilindro
Vertical system with knob for cylinder

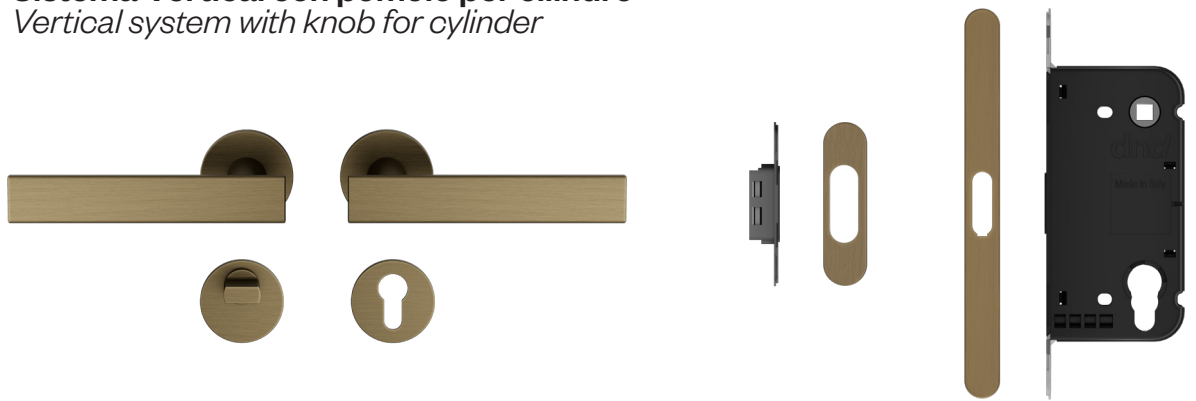

Sistema Vertical con bocchette foro Yale
Vertical system with Yale hole escutcheons

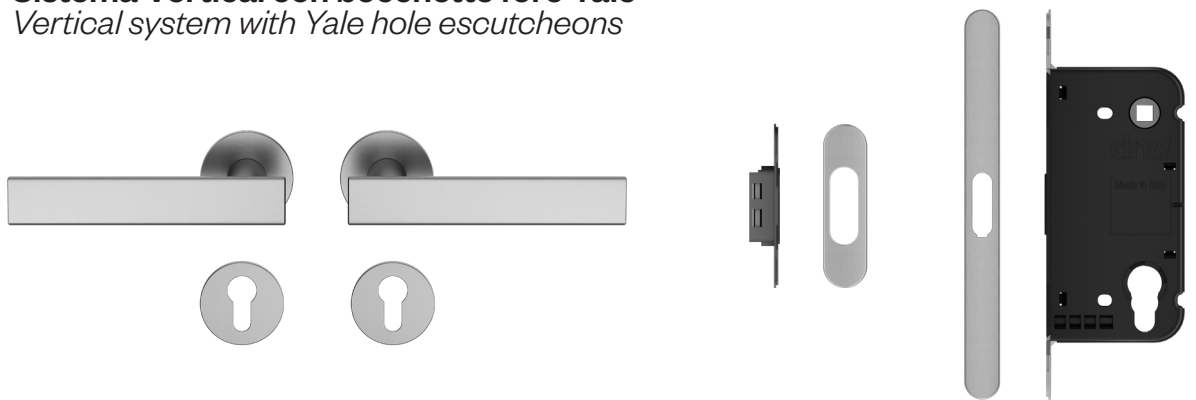

Sistema Vertical senza bocchette
Vertical system without escutcheons

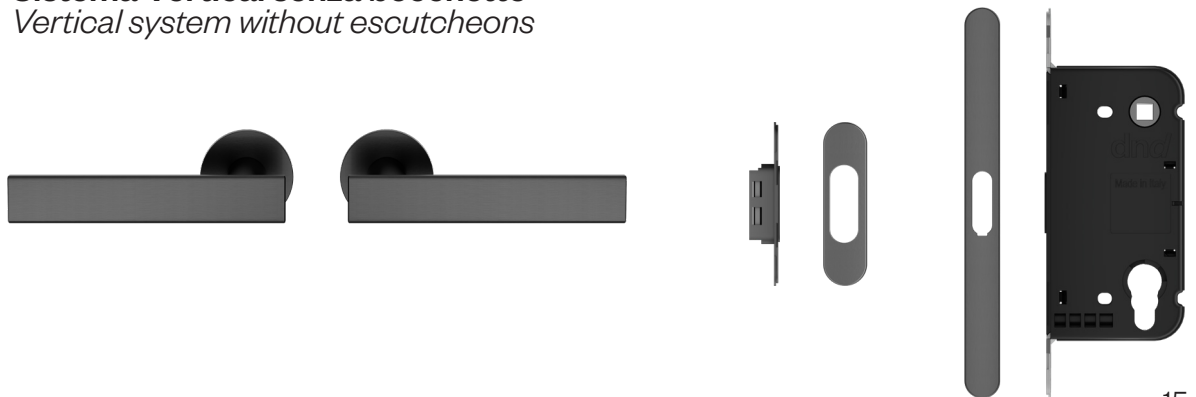





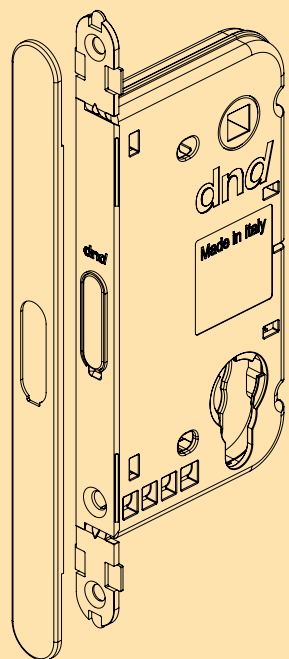
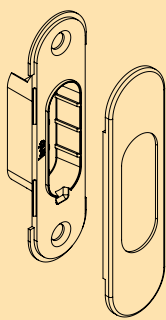
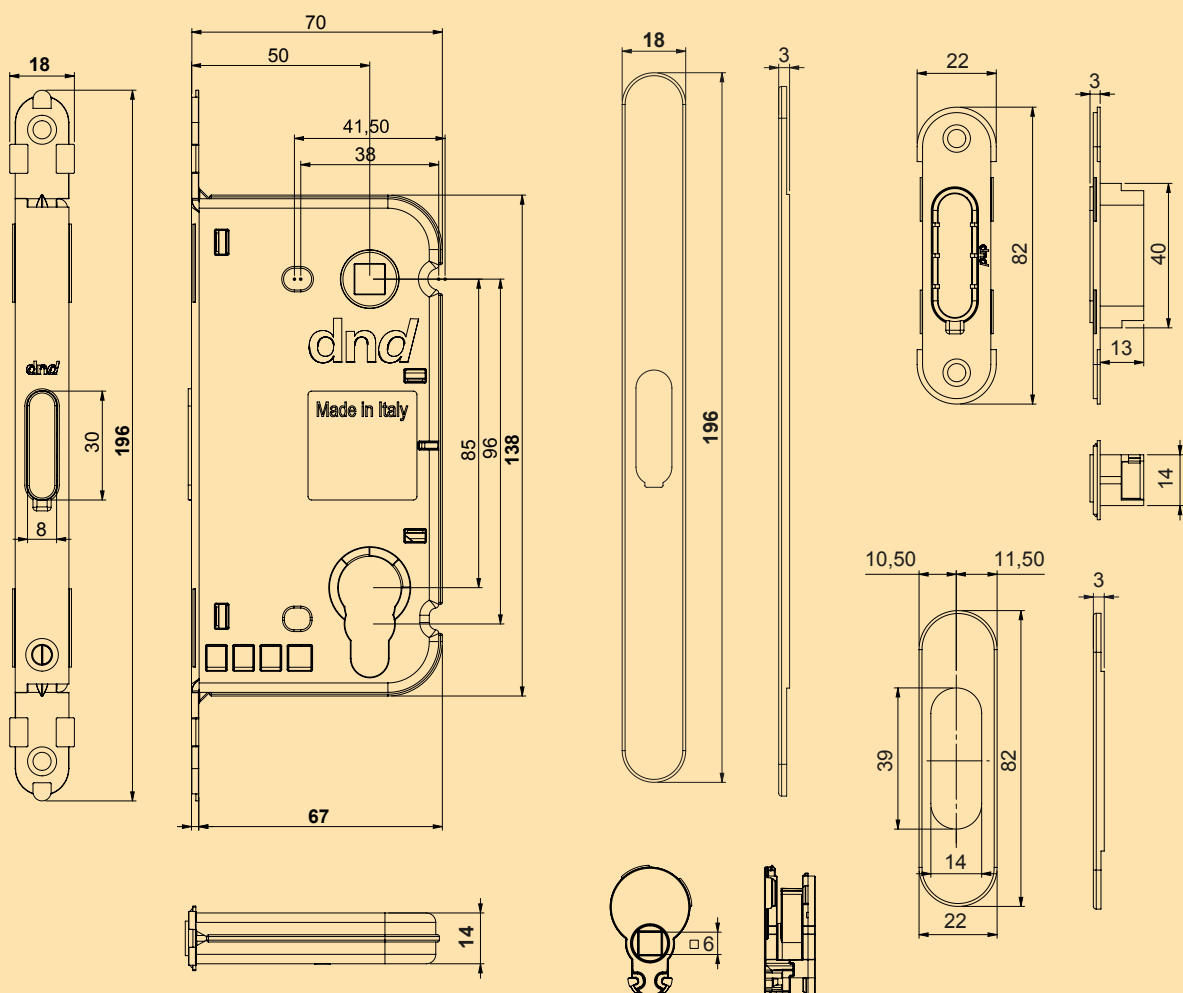

vertical

dimensioni in millimetri
dimensions in millimetres



-  cilindro / cylinder
-  nottolino / turn and release
-  cilindro codolo / knob for cylinder
-  50 entrata 50mm / backset 50mm

dynamic

sistema di chiusura
con magnete

*magnet locking
system*

la semplicità nell'aprire e nel chiudere

opening and closing made easy

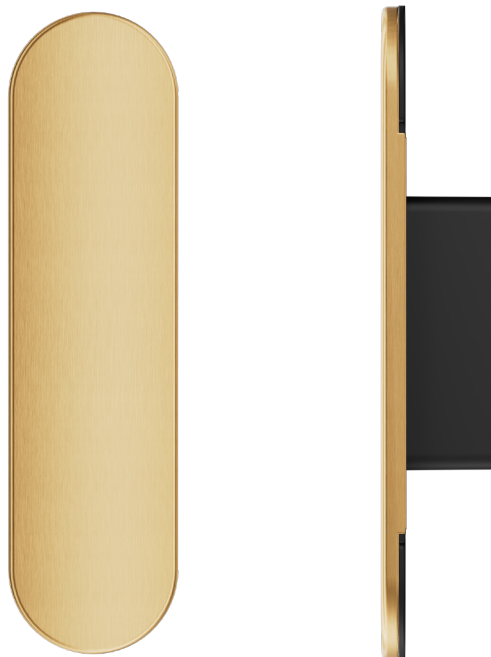

Dynamic è un sistema di chiusura per porte a battente, senza bloccaggio, che integra un **supporto magnetico di attrazione**: grazie a esso, la porta o il pannello non hanno più bisogno di un corpo serratura. Le azioni dell'aprire e del chiudere si fanno, così, **semplici e intuitive**.

Nella concezione contemporanea della porta come complemento d'arredo, oltre che come classico separatore tra ambienti e spazi, Dynamic **agevola il gesto di relazione con l'anta** e valorizza al massimo le esigenze della progettazione e i **desideri di personalizzazione**. L'integrazione del sistema Dynamic nel disegno della porta e degli ambienti domestici lascia grande spazio alla creatività dell'interior designer.

*Dynamic is a locking system for hinged doors with an **integrated magnetic surface** and no physical lock: as a result, doors and panels no longer require a lock body. The opening and closing actions have been **made simple and intuitive**.*

*In keeping with the contemporary notion of a door as both a furnishing accessory and a traditional way to separate rooms and spaces, Dynamic **facilitates the act of relating to the door** and makes the most of the design needs and **customisation desires**. By integrating the Dynamic system into the design of the door and home environments, ample space is left for interior designer creativity.*



la forza dell'attrazione magnetica

the force of magnetic attraction

Il sistema Dynamic è composto da una base che accoglie il **magnete**, da una cover di ottone e da un supporto di polo opposto che attrae e blocca l'anta. La ritenuta dell'anta si attiva tramite la sola forza magnetica, **senza viti a vista** e senza lo stretto contatto tra elementi che è necessario nello scrocco tradizionale.

I poli magnetici del sistema possono essere fissati alla porta sia nella classica posizione sullo stipite – in verticale – sia nel traverso superiore del telaio, dunque in posizione orizzontale. Inoltre, le cover di Dynamic sono **realizzabili in tutte le finiture** del catalogo Dnd.

*The Dynamic system comprises a **magnet-housing base**, a brass cover and an opposite pole support that attracts and locks the door. The door lock is activated by magnetic force alone, with **no visible screws** or the close contact of elements needed for a traditional latch.*

*The system's magnetic poles can be fixed to the door either in the classic position on the jamb – vertically – or on the upper crosspiece of the frame, i.e. horizontally. Furthermore, the Dynamic covers are available in **all the finishes** offered in the Dnd catalogue.*

Cover Cover

In ottone, nella stessa finitura della maniglia
In brass with the same finish as the handle



Supporto magnetico Magnetic holder

Cassa in POM con elementi magnetici
POM body with magnetic elements



tecnologia e versatilità

technology and versatility



Posizionamento

Il sistema può essere fissato alla porta sia in verticale sia in orizzontale

Positioning

The system can be mounted on the door either vertically or horizontally

design e qualità

design and quality



Ritenuta magnetica della porta

Magnetic retention of the door



Flessibilità nel posizionamento

Position flexibility



Senza viti a vista

No visible screws

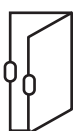

Apertura semplice e intuitiva

Simple and intuitive opening



Coerenza estetica tra gli elementi

Aesthetic consistency among the elements



Disponibile in tutte le finiture a catalogo

Available in all finishes of the catalogue

dimensioni in millimetri
dimensions in millimetres

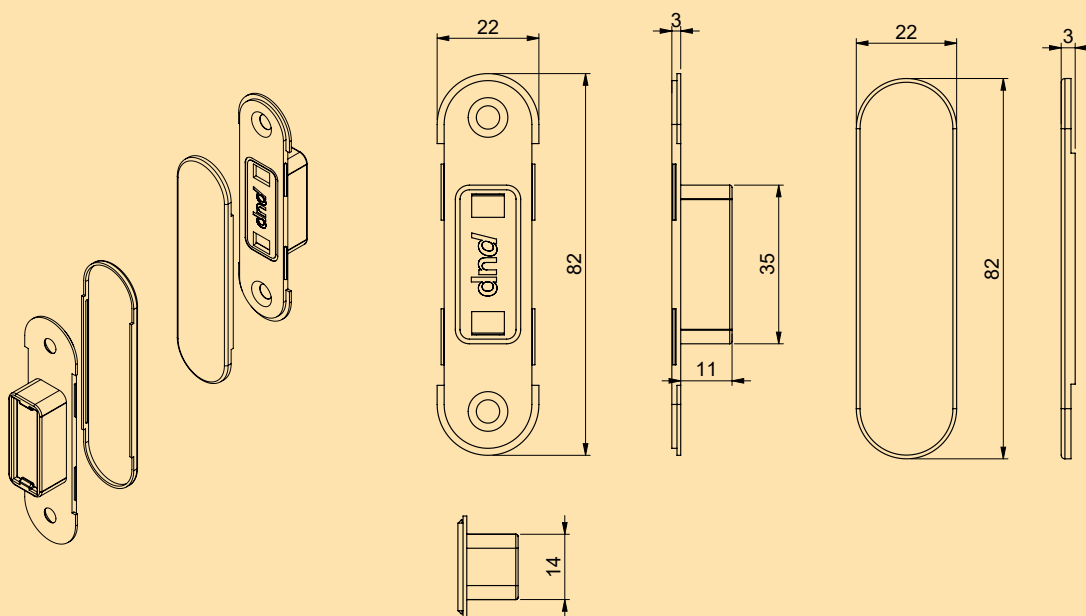



PVD-BG forte*
Oro antico
lucido
*Antique
bright gold*



PVD-SG forte*
Oro antico
satinato
*Antique
satin gold*



PVD-SH forte*
Oro champagne
satinato
*Champagne
satin gold*



PVD-BB forte*
Bronzo lucido
Bright bronze



PVD-SB forte*
Bronzo satinato
Satin bronze



PGS forte*
Grafite satinato
Satin graphite



OGH
Bronzo satinato
opaco
*Matt satin
bronze*



OCS
Cromo satinato
Satin chrome



OC
Cromo lucido
Polished chrome



ONO
Nero
Black



OBN
Bianco
White



OSV
Silver
Silver



OBT
Turchese
Turquoise



OBC
Blu colomba
Blue dove



OVP
Violetto pastello
Pastel violet



OGO
Giallo oliva
Yellow olive



OBR
Bronzo
Bronze



ORA
Oro satinato
Satin gold

interna

Una maniglia per un gesto
nuovo e intuitivo

*A handle for a new, intuitive
gesture*

l'immediatezza svincolata dalla meccanica

immediacy released from mechanics

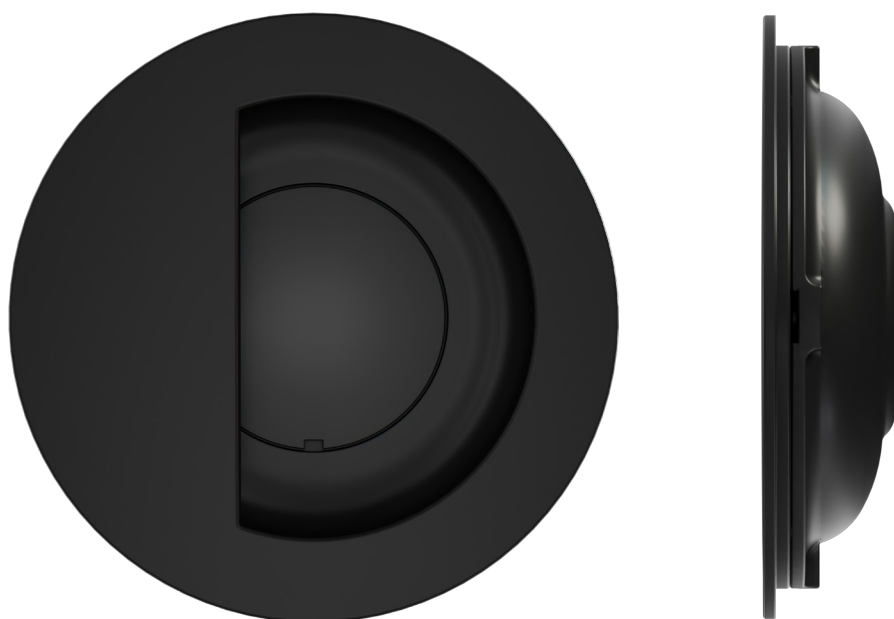

design:
Giulio lacchetti

Interna è una maniglia che nasce unitamente al nuovo sistema Dynamic: si tratta di **un oggetto dal design minimale e dal profilo circolare**, pensato per essere inserito nel pannello della porta e accogliere la mano all'interno di una pratica e accogliente concavità smussata.

Interna segna una svolta nel catalogo Dnd: è una presa che non implica un movimento, in quanto non è legata al tradizionale apparato meccanico della porta. **Interna non ingombra e non sporge dalla superficie del pannello.** È realizzata in zama ed è disponibile in nove diverse finiture, per soddisfare al meglio i desideri della progettazione a livello cromatico.

*Interna is a handle that was created alongside the new Dynamic system: **it boasts a minimal design, circular profile** and has been designed to be inset into the door panel to provide a practical and welcoming bevelled concave for your hand.*

*Interna marks a turning point in the Dnd product range: its grip does not imply movement as it is not linked to the door's traditional mechanical device. **Interna is compact and sits flush with the surface of the panel.** It is made of zamak and available in nine different finishes to best satisfy the designer's whims in terms of colour.*





interna

design:
Giulio lacchetti

made in Italy



Interna genera un **gesto nuovo** e intuitivo di relazione con la porta, grazie alla sua facilità di lettura: è un **segno geometrico semplice**, senza complicazioni formali, che invita con immediatezza alla presa, all'apertura e alla chiusura.

*Interna creates a new, **intuitive relationship** with the door, thanks to its user-friendliness: the **simple geometric shape** with no overly complicated elements makes grasping, opening and closing much more inviting.*

finiture *finishes*

zama zamak

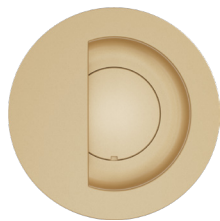

ZRO
Oro
gold



ZBR
Bronzo
Bronze

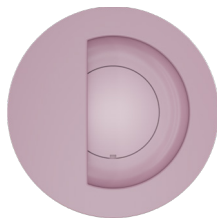

ZVP
Violetto pastello
Pastel violet

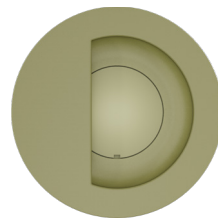

ZGO
Giallo oliva
Yellow olive

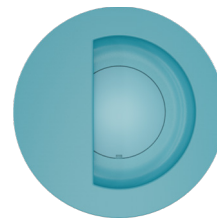

ZBT
Turchese
Turquoise

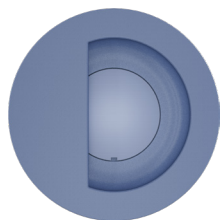

ZBC
Blu colomba
Blue dove



ZSV
Silver
Silver



ZBN
Bianco
White



ZNE
Nero
Black

dimensioni in millimetri *dimensions in millimetres*

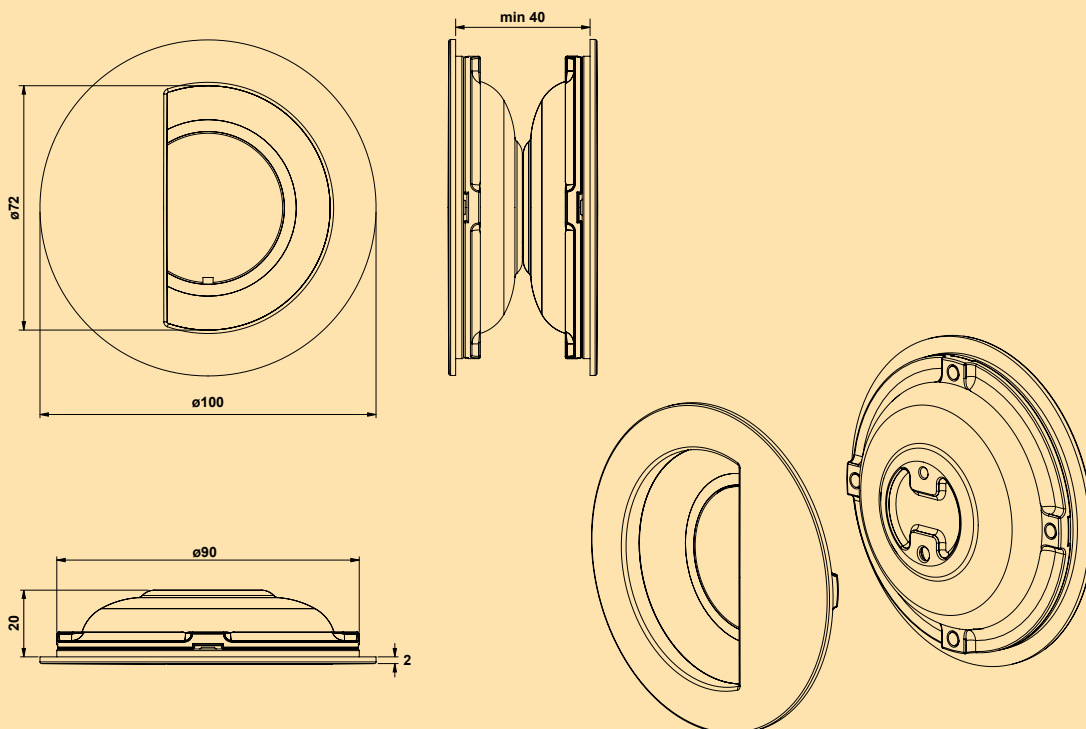

Progetto grafico /
Graphic design
Lorenzo De Bon
Irene Sartor
- Webkolm -

Fotografie /
Photographs
Tiziano Reguzzi

Render 3D /
Render 3D
Michele Faccoli

Stampa /
Printing
Tipolitografia Pagani

dnd

Dnd Martinelli S.r.l.
Via Piani di Mura, 2
25070 Casto (BS) - Italia

T +39 0365 899113
info@dndhandles.it

www.dndhandles.it



© 2024 Dnd Martinelli S.r.l.

Tutti i diritti riservati
All rights reserved

dnd

handles
with care

dndhandles.it
made in italy



Versione digitale
della brochure

*Digital version
of the brochure*