

dnd

disegni
tecnici

– technical
drawings

airone

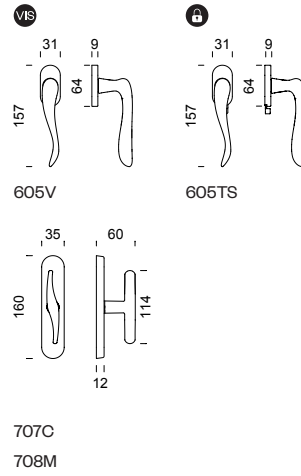
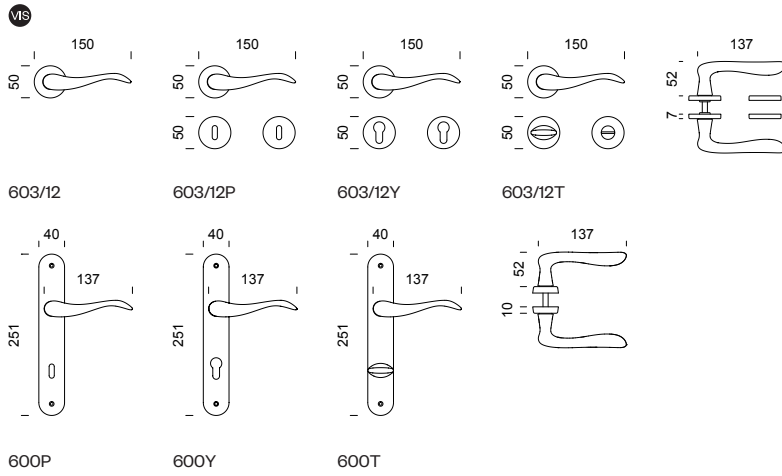

anik NEW

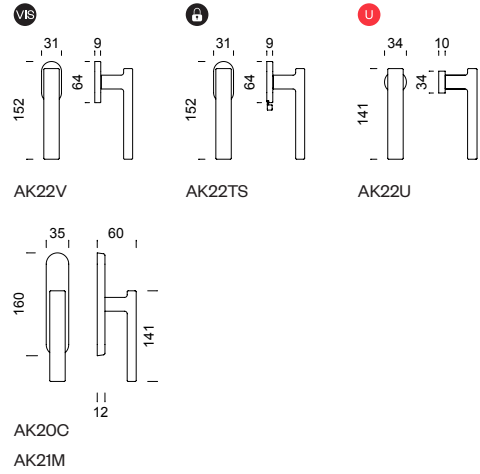
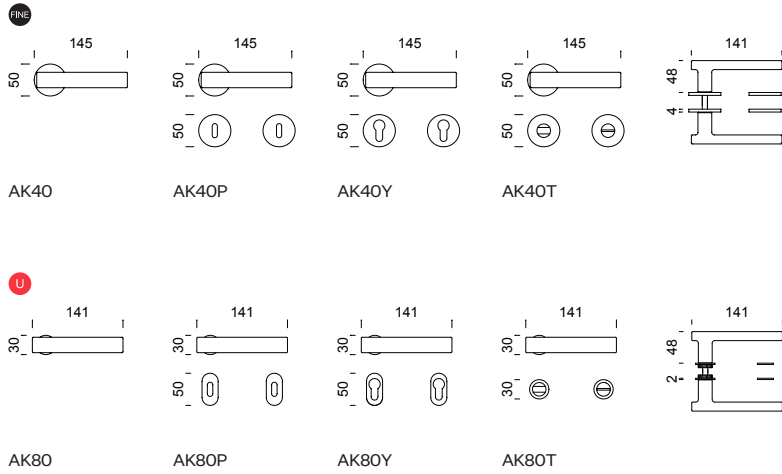

anik 02 NEW

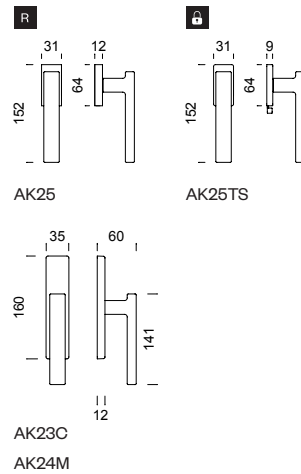
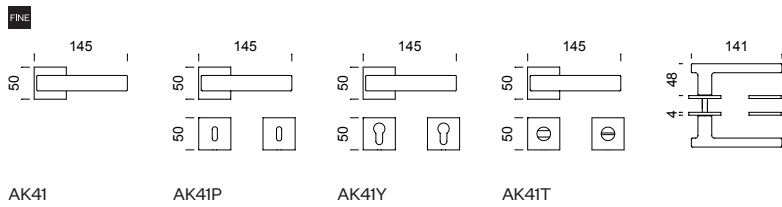

anik brilliant NEW

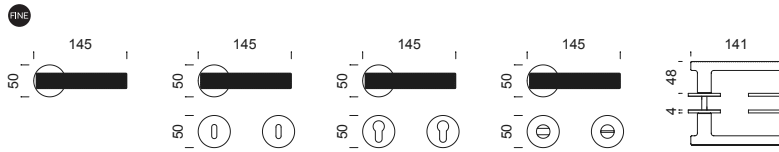

AB40 AB40P AB40Y AB40T

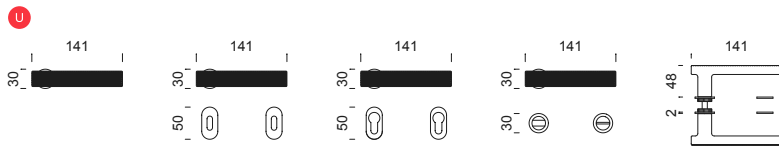

AB80 AB80P AB80Y AB80T

anik brilliant 02 NEW

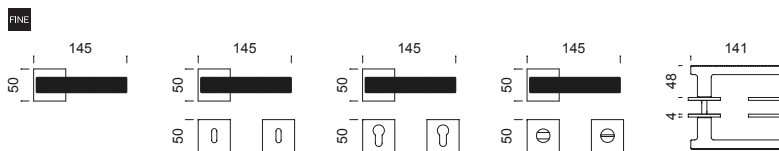

AB41 AB41P AB41Y AB41T

anik line NEW

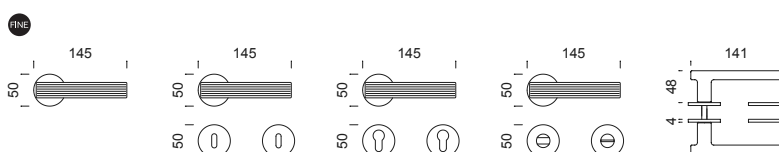

AE40 AE40P AE40Y AE40T

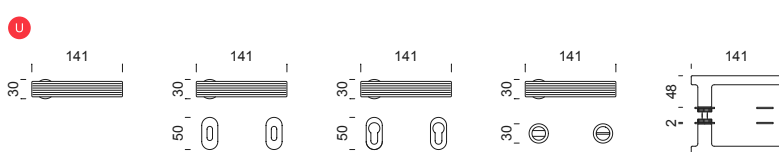

AE80 AE80P AE80Y AE80T

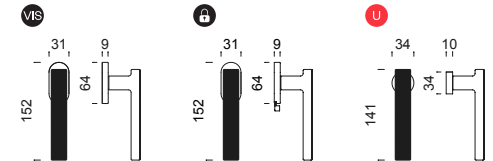

AB22V AB22TS AB22U

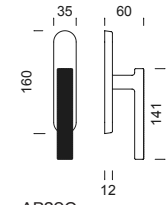

AB20C
AB21M

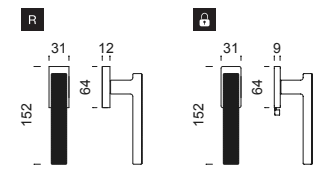

AB25 AB25TS

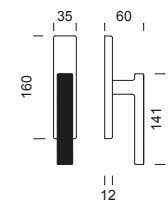

AB23C
AB24M

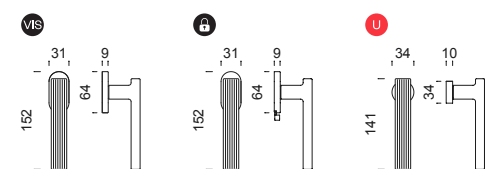

AE22V AE22TS AE22U

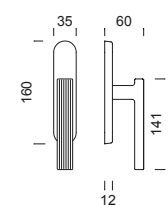

AE20C
AE21M

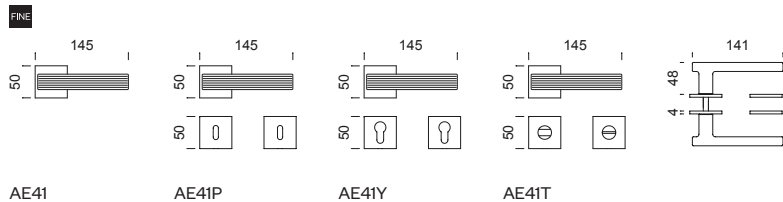

AE41

AE41P

AE41Y

AE41T

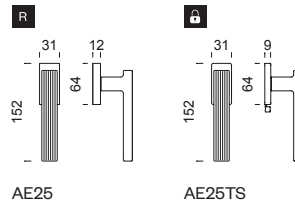

AE25

AE25TS

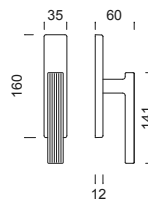

AE23C

AE24M

appia

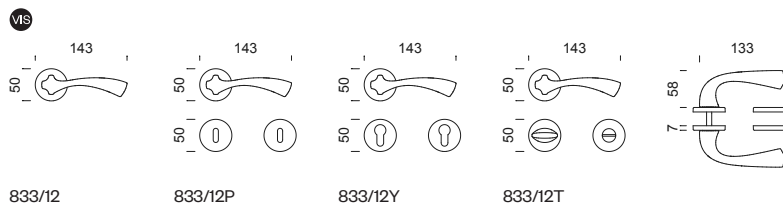

833/12

833/12P

833/12Y

833/12T

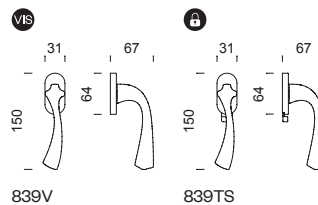

839V

839TS

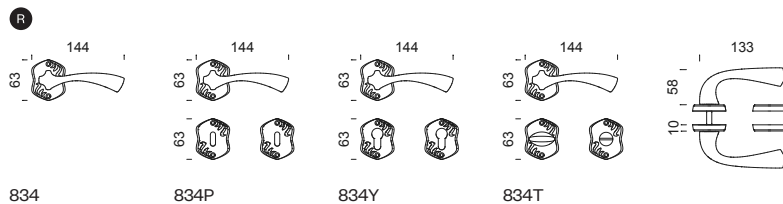

834

834P

834Y

834T

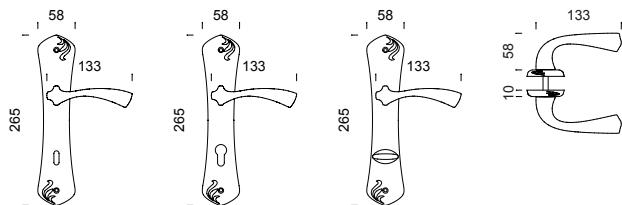

830P

830Y

830T

aretè

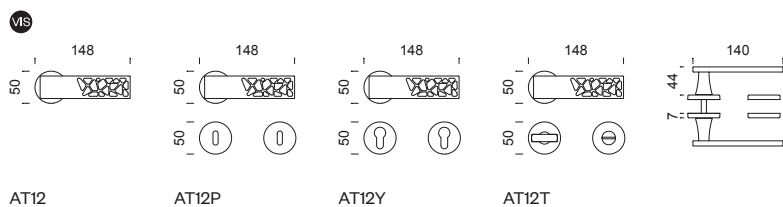

AT12

AT12P

AT12Y

AT12T

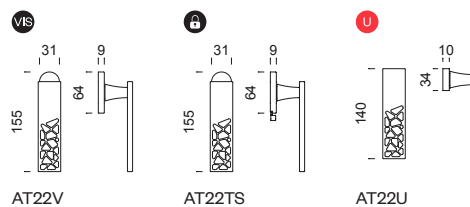

AT22V

AT22TS

AT22U

aretè

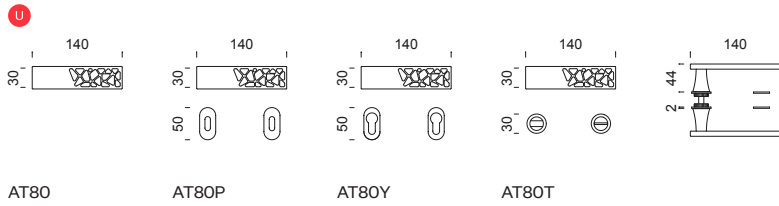
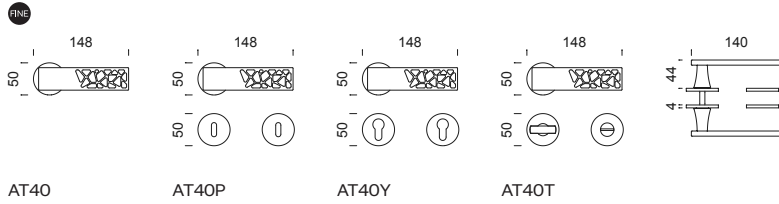

aretè 02

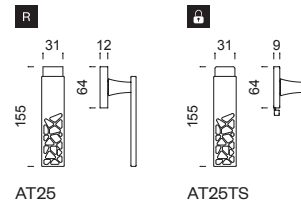
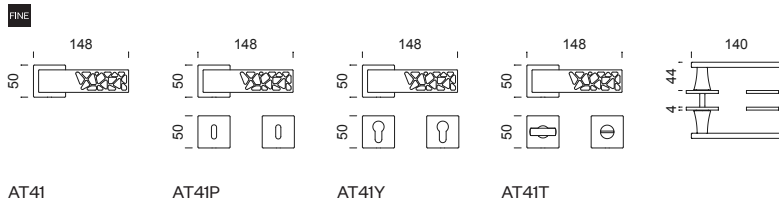
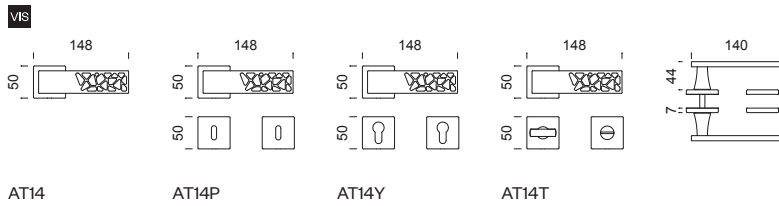

aretè L

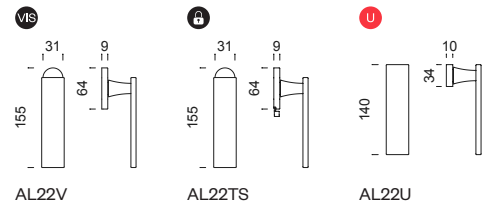
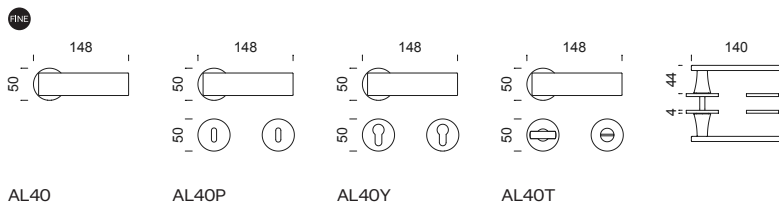
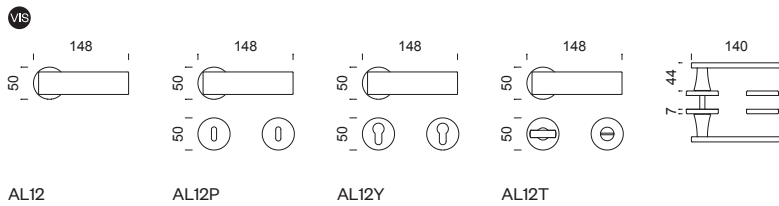

aretè L

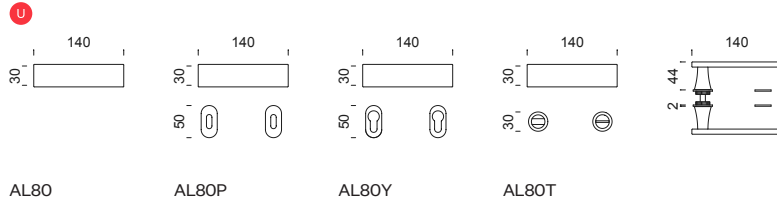

AL80

AL80P

AL80Y

AL80T

aretè L 02

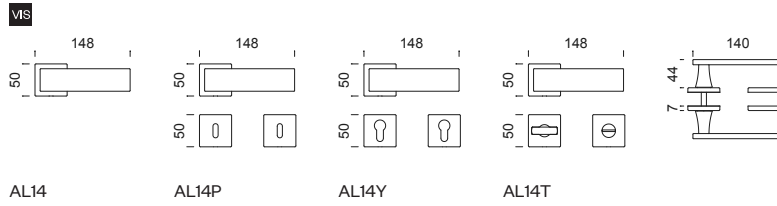

AL14

AL14P

AL14Y

AL14T

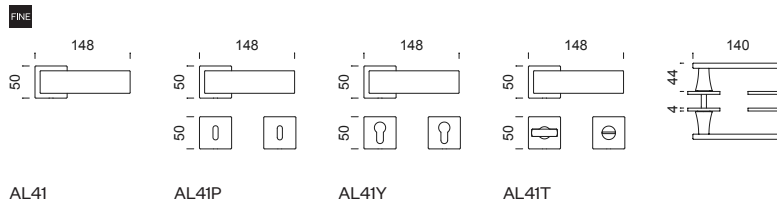

AL41

AL41P

AL41Y

AL41T

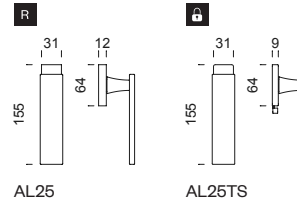

AL25

AL25TS

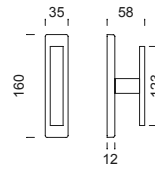

ED26C

ED26M

art

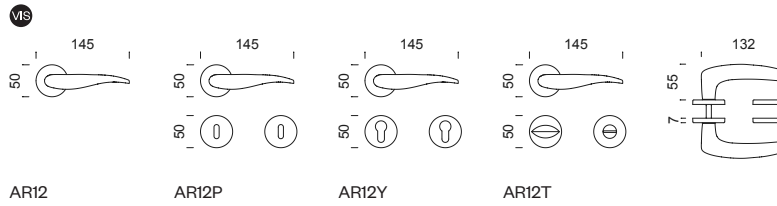

AR12

AR12P

AR12Y

AR12T

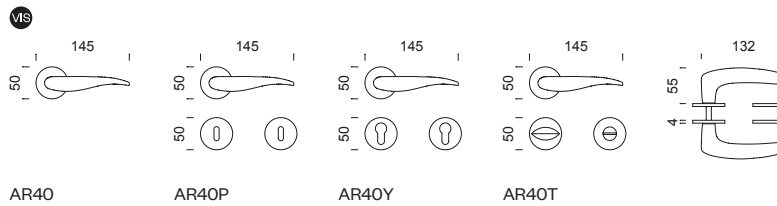

AR40

AR40P

AR40Y

AR40T

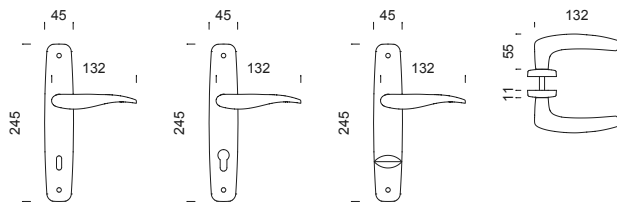

AR10P

AR10Y

AR10T

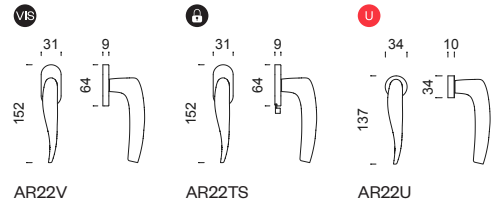

AR22V

AR22TS

AR22U

art

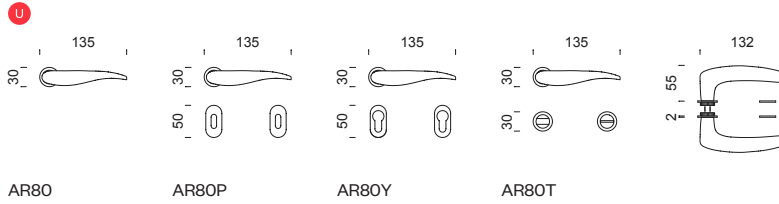

AR80 AR80P AR80Y AR80T

artik

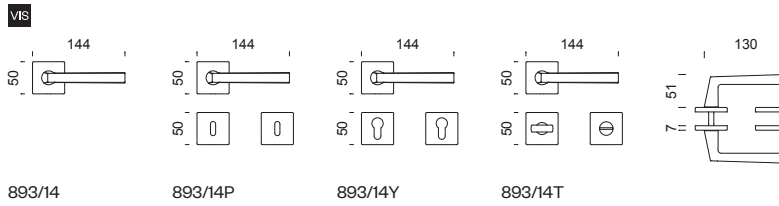

893/14 893/14P 893/14Y 893/14T

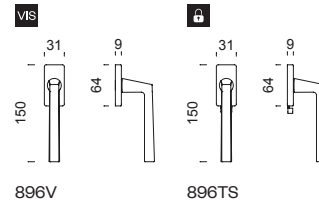

896V 896TS

beauty

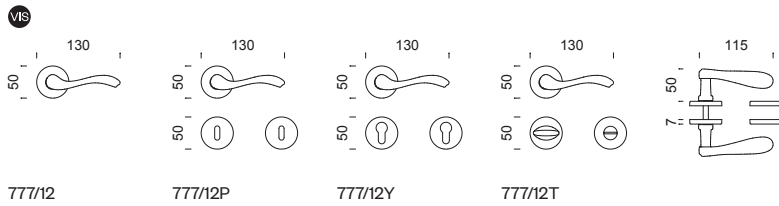

777/12 777/12P 777/12Y 777/12T

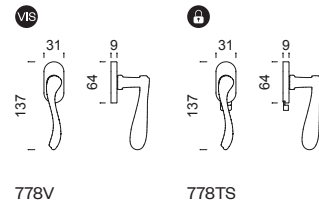

778V 778TS

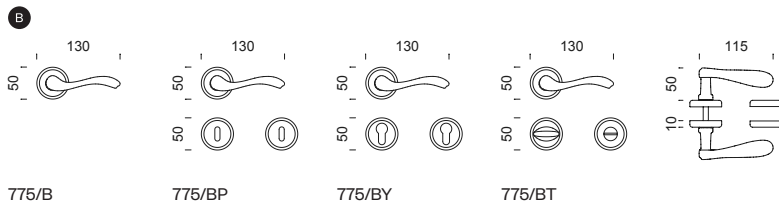

775/B 775/BP 775/BY 775/BT

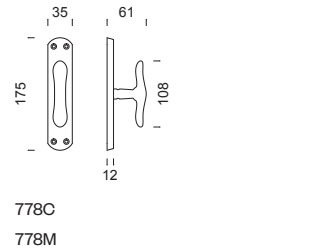

778C 778M

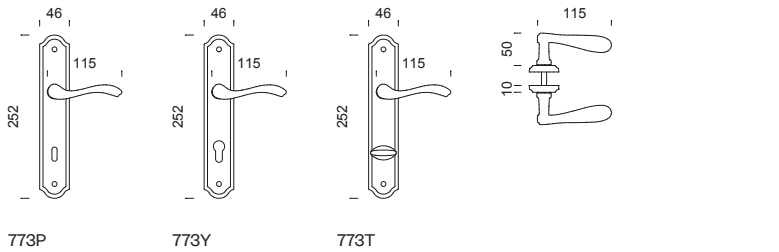

773P 773Y 773T

blend

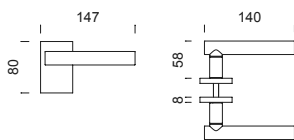

BN10/R

blend

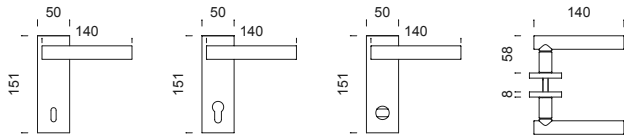

BN10P

BN10Y

BN10T

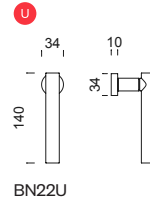

BN22U

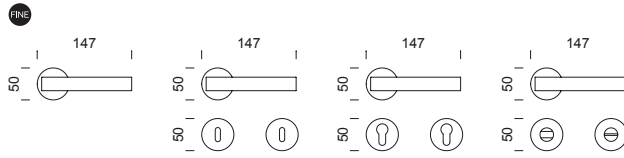

BN40

BN40P

BN40Y

BN40T

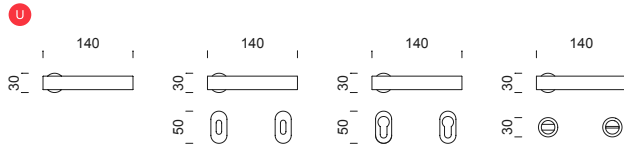

BN80

BN80P

BN80Y

BN80T

blend O2

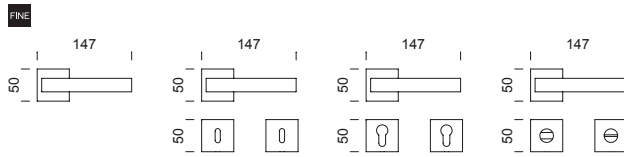

BN41

BN41P

BN41Y

BN41T

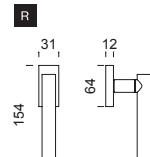

BN25

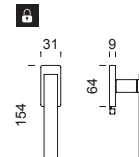

BN25TS

blip

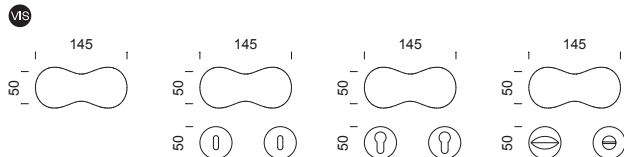

BL12

BL12P

BL12Y

BL12T

boole

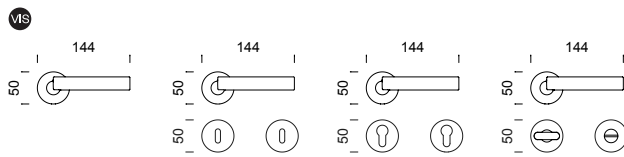

BE12

BE12P

BE12Y

BE12T

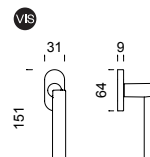

BE22V

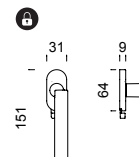

BE22TS

boole

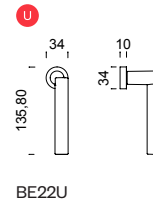
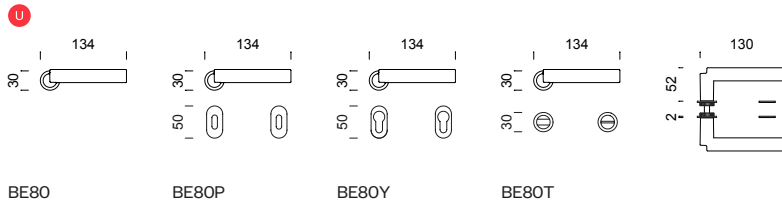
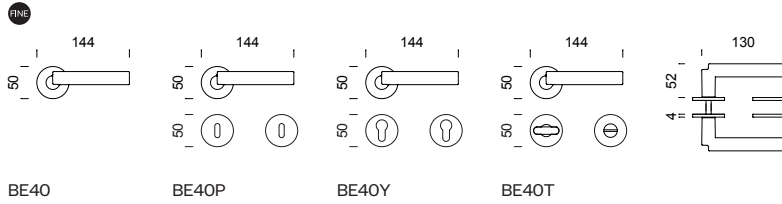

bruxelles

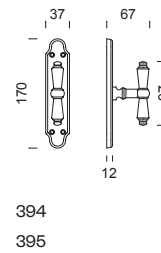
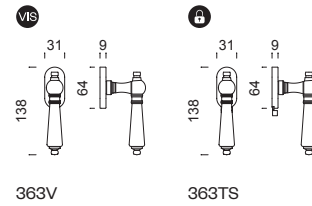
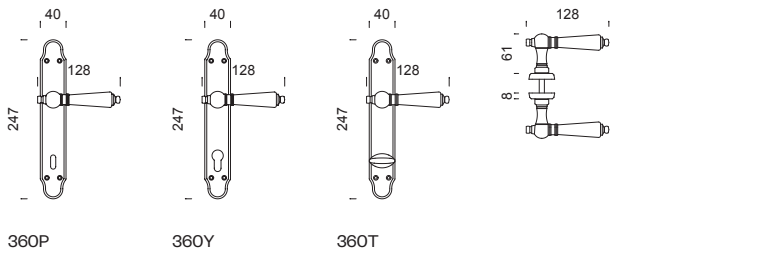
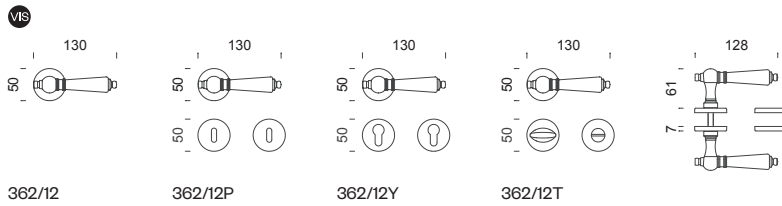

C-1918

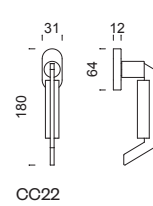
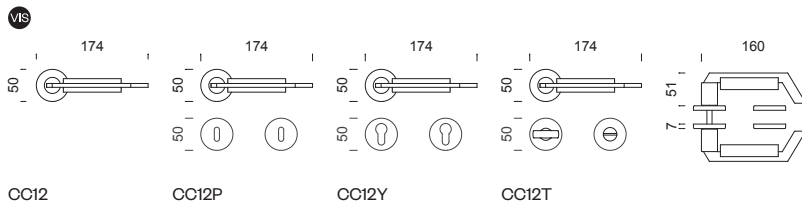

change B 02

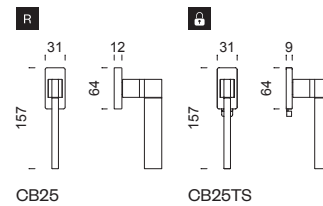
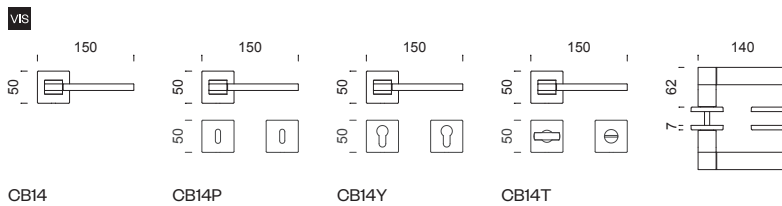

chop

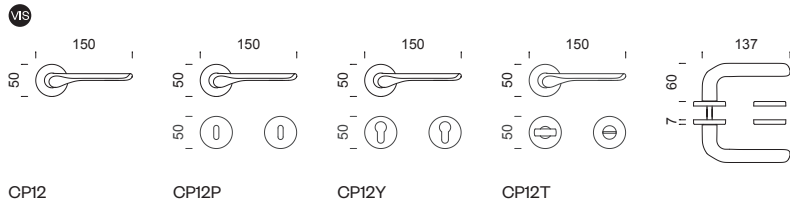

CP12

CP12P

CP12Y

CP12T

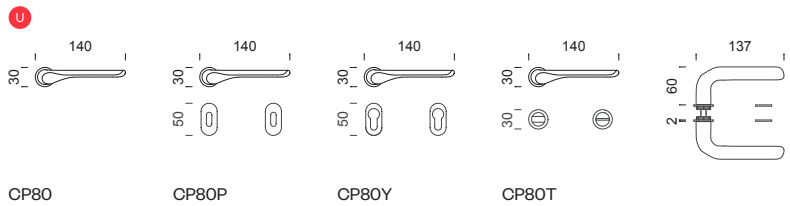

CP80

CP80P

CP80Y

CP80T

classic

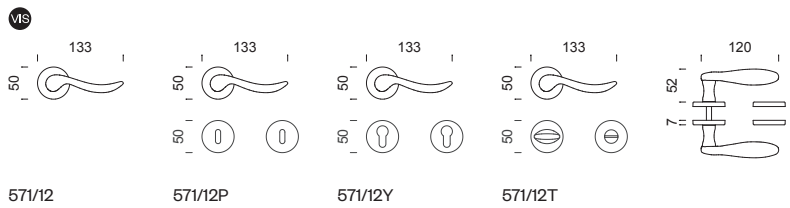

571/12

571/12P

571/12Y

571/12T

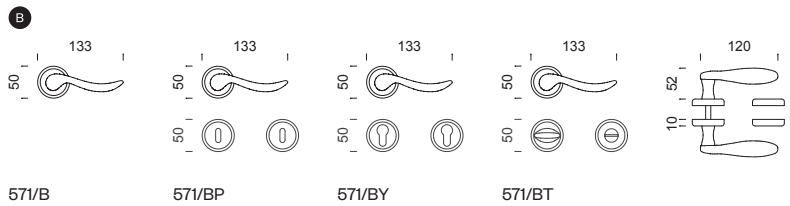

571/B

571/BP

571/BY

571/BT

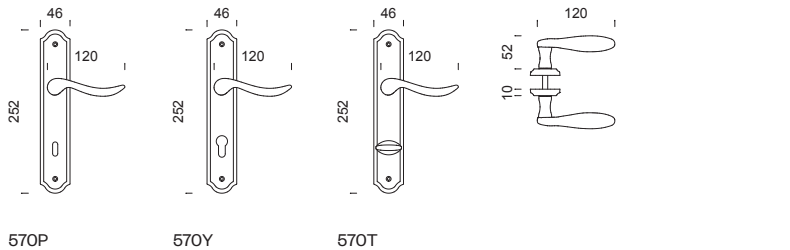

570P

570Y

570T

cloe

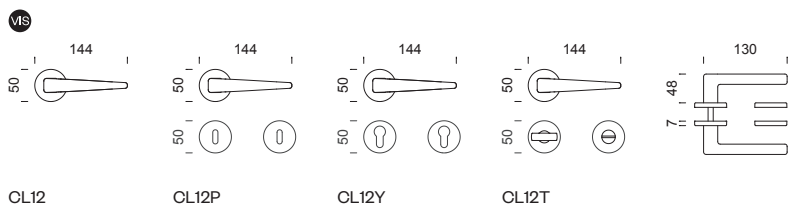

CL12

CL12P

CL12Y

CL12T

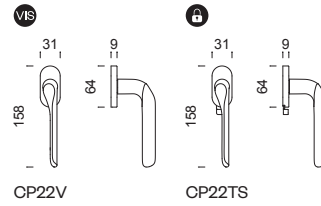

CP22V

CP22TS

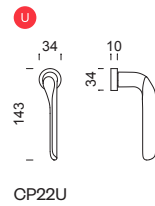

CP22U

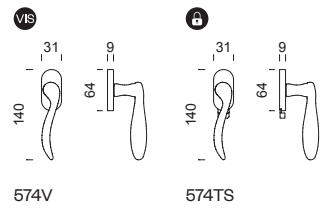

574V

574TS

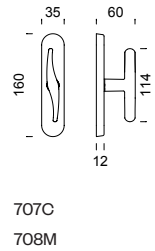

707C

708M

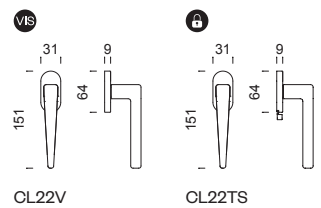

CL22V

CL22TS

cloe

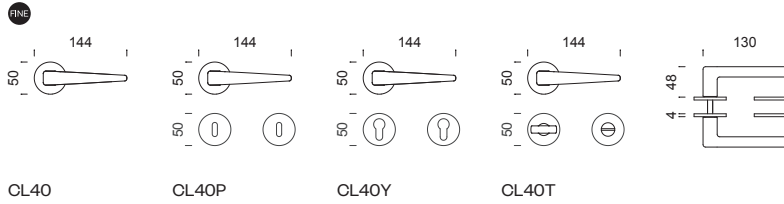

CL40 CL40P CL40Y CL40T

cloe 02

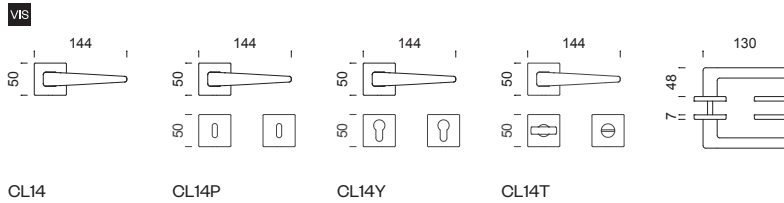

CL14 CL14P CL14Y CL14T

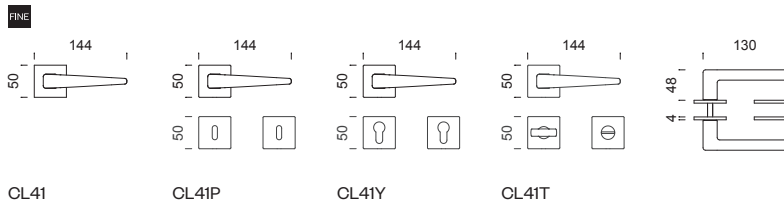

CL41 CL41P CL41Y CL41T

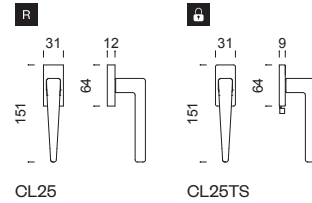

CL25 CL25TS

crisalide NEW

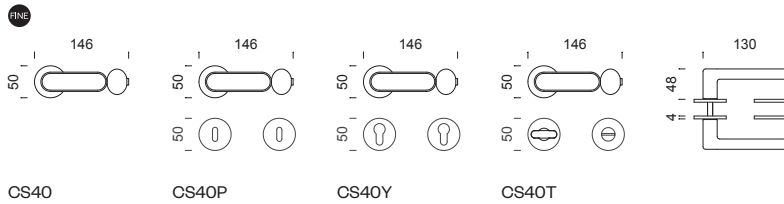

OS40 OS40P OS40Y OS40T

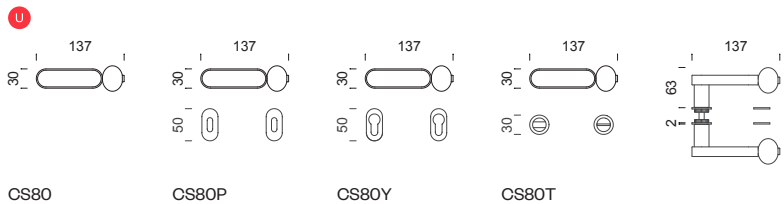

CS80 CS80P CS80Y CS80T

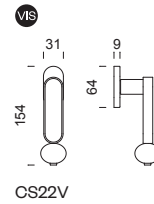

OS22V

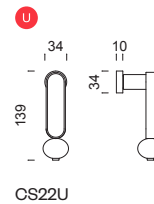

CS22U

crisalide mini NEW

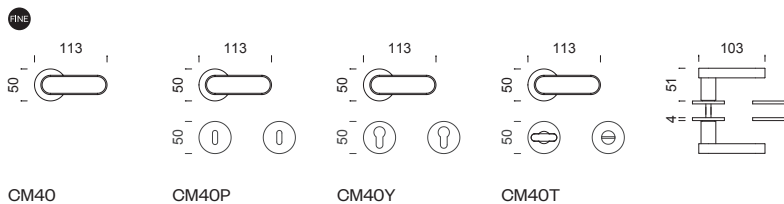

CM40 CM40P CM40Y CM40T

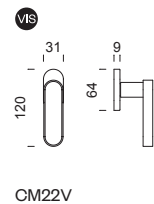

CM22V

crislide mini NEW

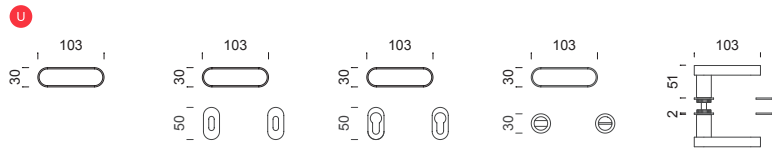

CM80 CM80P CM80Y CM80T

disegni tecnici *technical drawings*

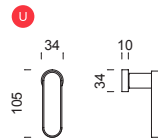

CM22U

daniela

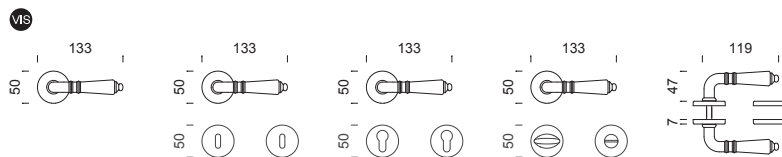

391/12 391/12P 391/12Y 391/12T

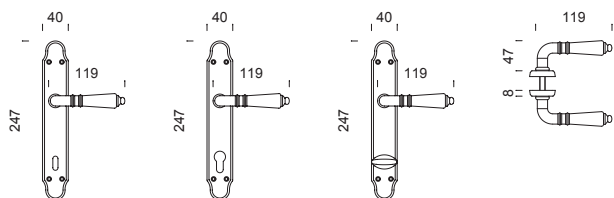

390P 390Y 390T

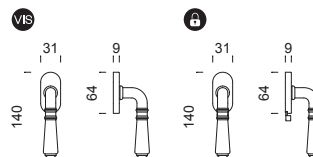

396V 396TS

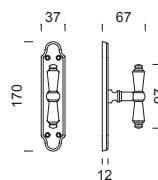

394 395

denise

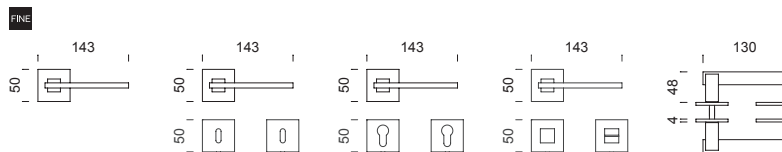

11/41 11/41P 11/41Y 11/41T

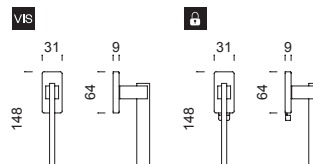

11V 11TS

dolce

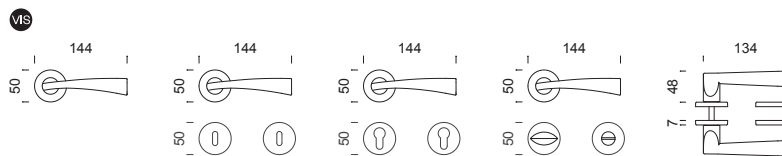

DO12 DO12P DO12Y DO12T

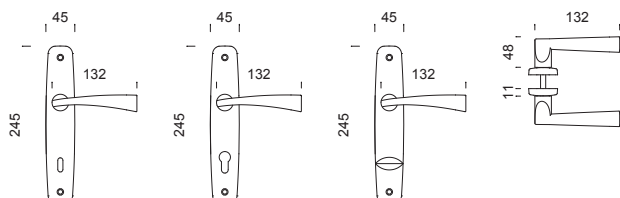

DO10P DO10Y DO10T

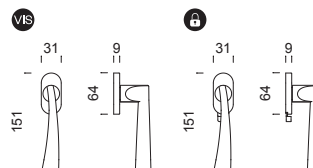

DO22V DO22TS

dolce

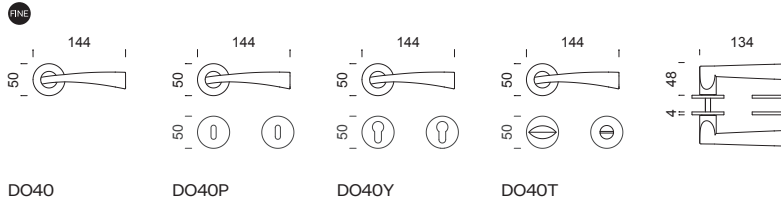

DO40 DO40P DO40Y DO40T

drop

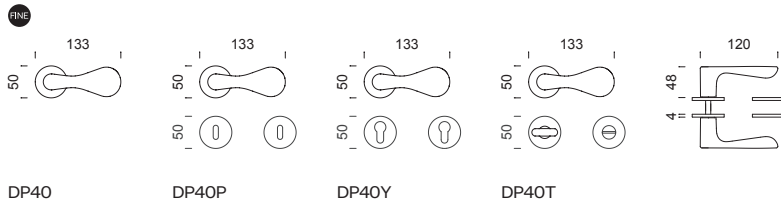

DP40 DP40P DP40Y DP40T

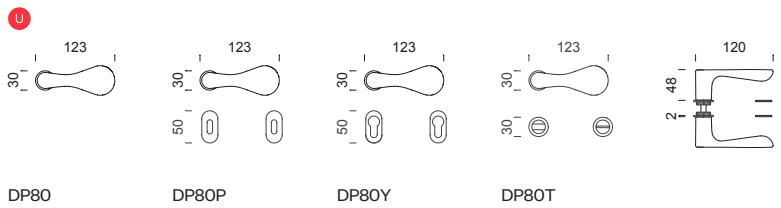

DP80 DP80P DP80Y DP80T

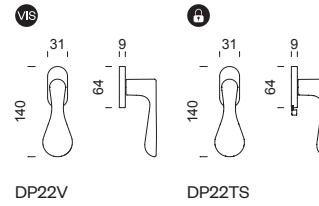

DP22V DP22TS

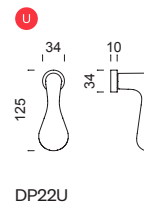

DP22U

DUE

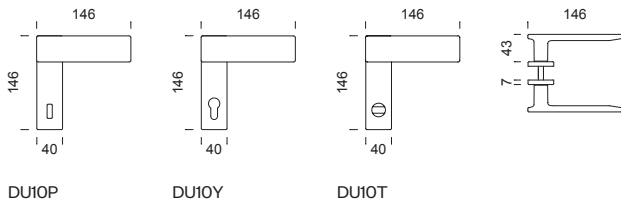

DU10P DU10Y DU10T

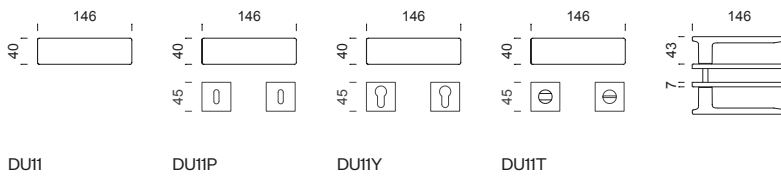

DU11 DU11P DU11Y DU11T

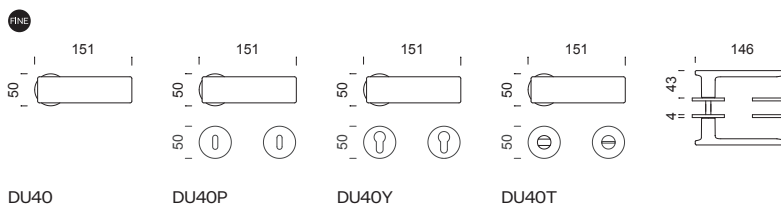

DU40 DU40P DU40Y DU40T

DUE

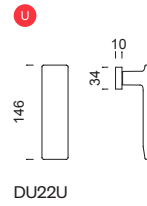
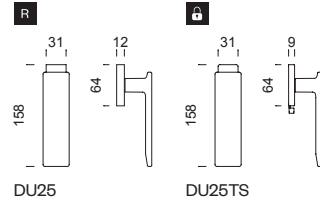
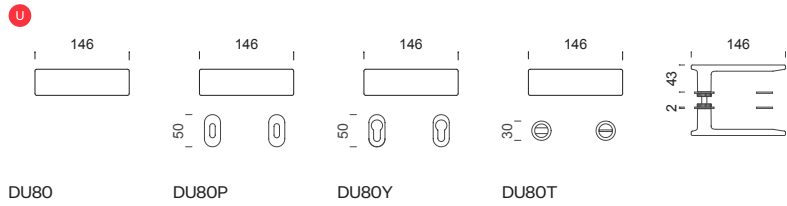
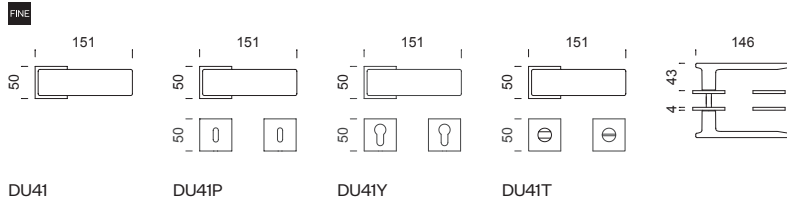

dune **NEW**

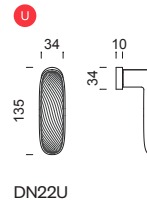
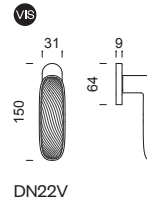
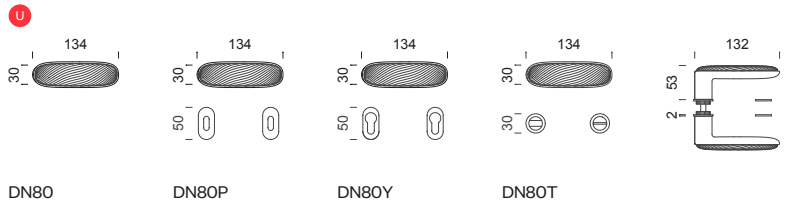
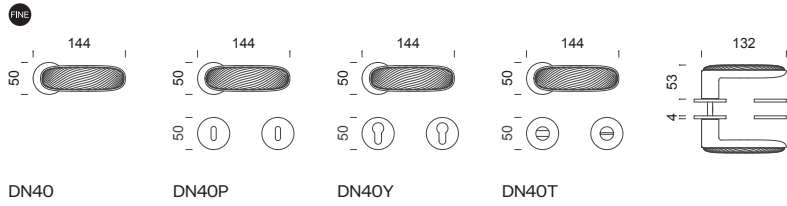

edra 02

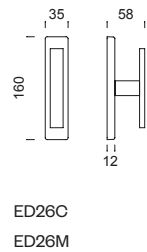
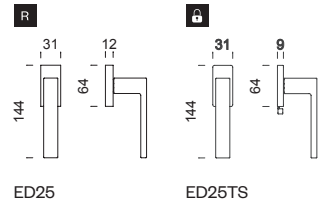
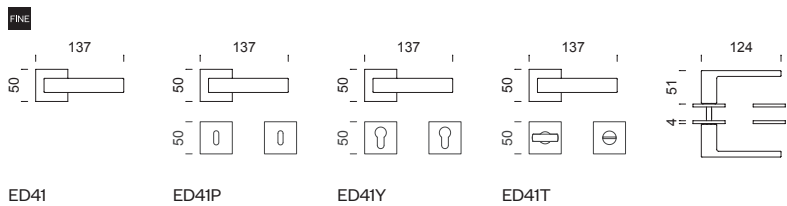
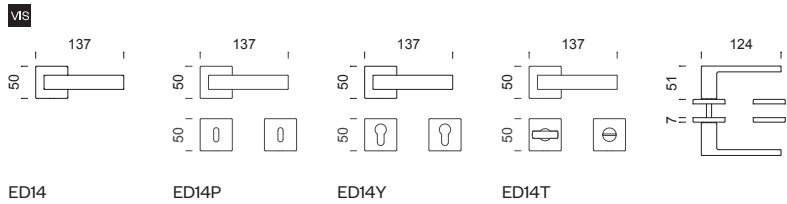

elena

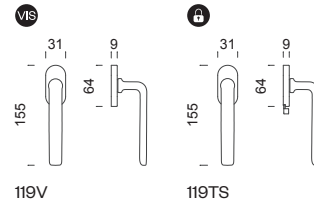
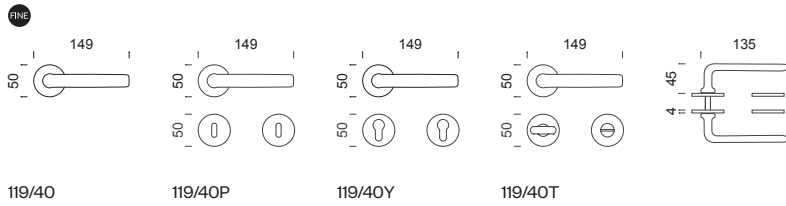
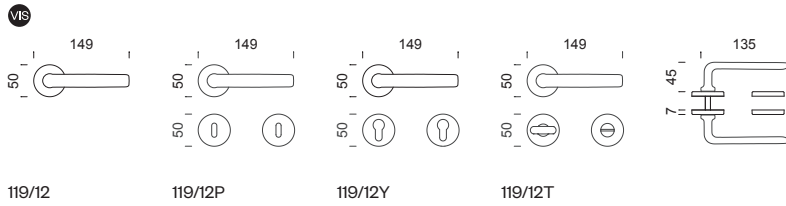

eleonora

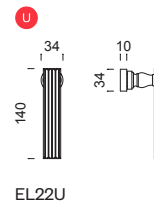
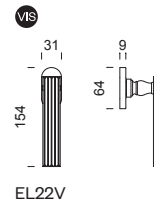
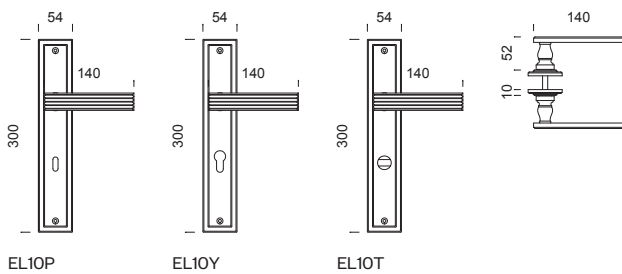
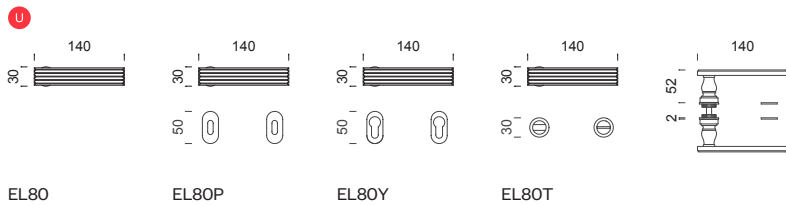
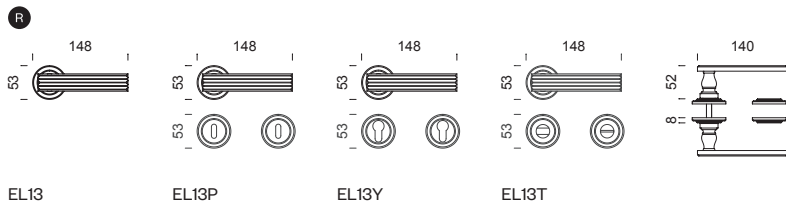
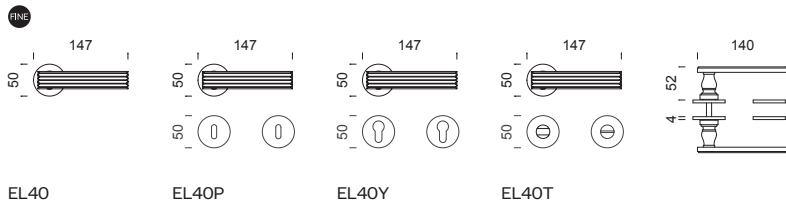

eleonora 02

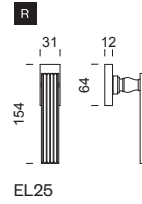
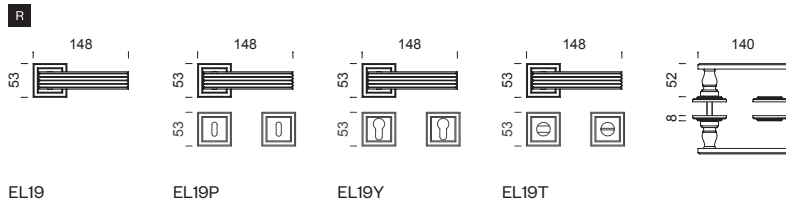
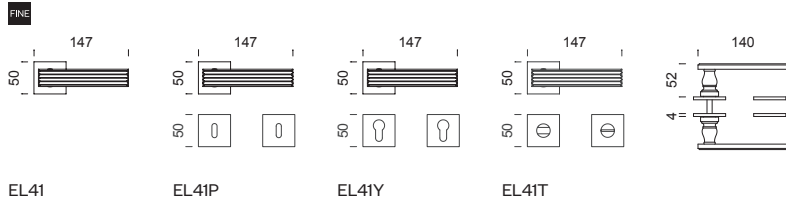

elle ^{new}

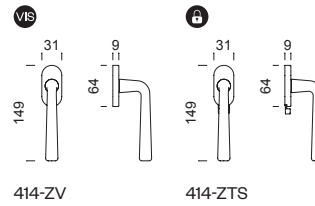
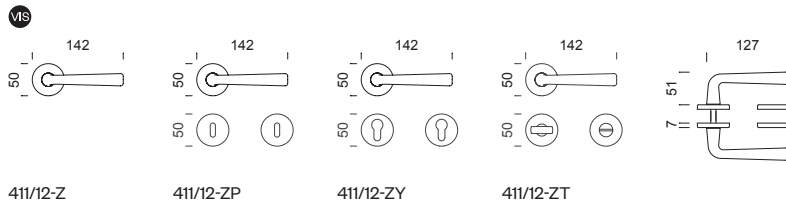

esa

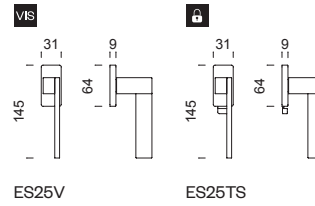
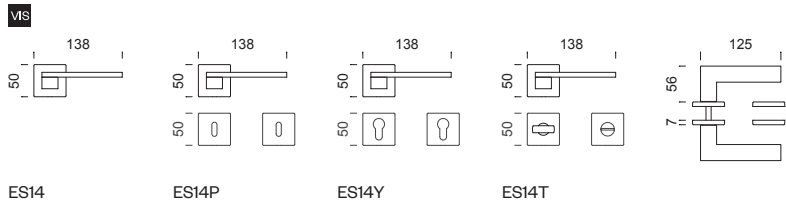

fedora

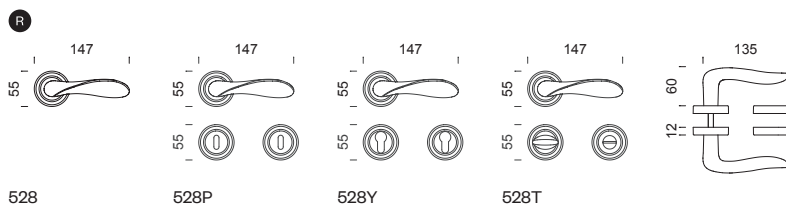
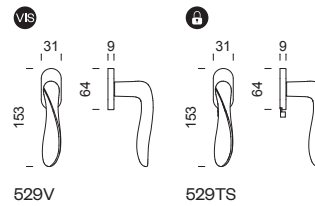
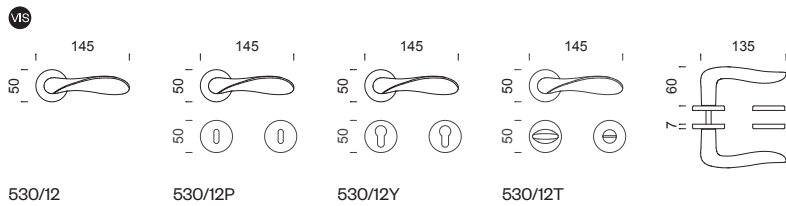

fiore

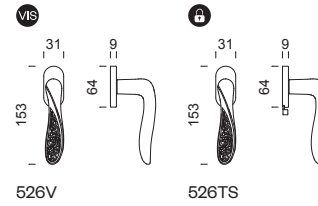
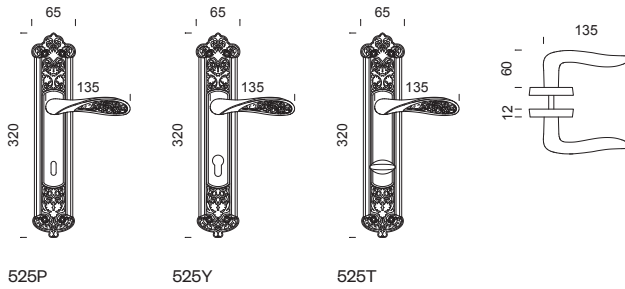
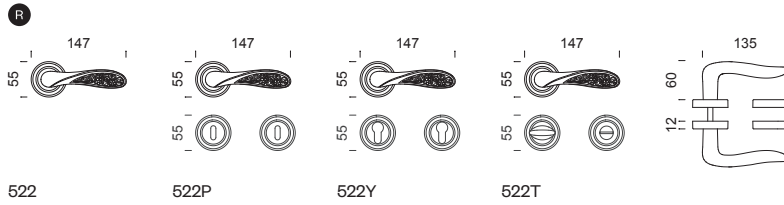
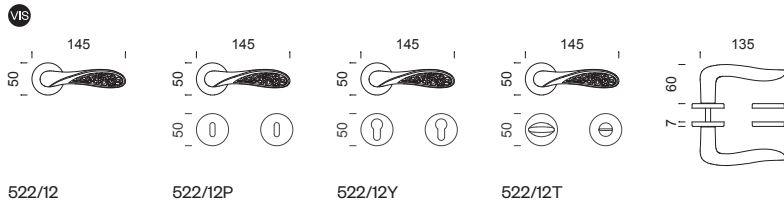

fiorenza

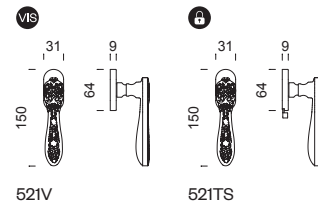
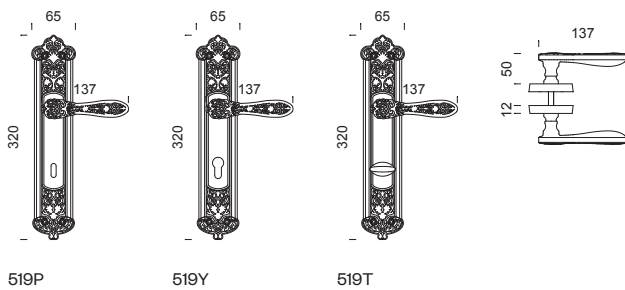
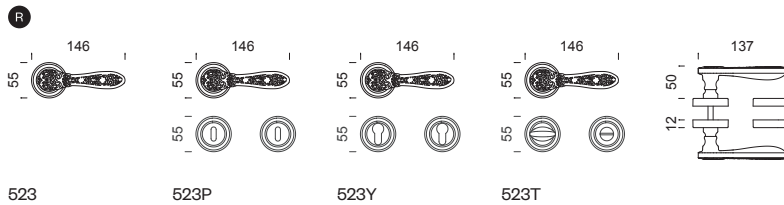
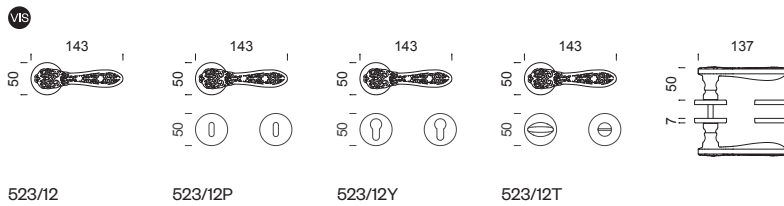

fluke

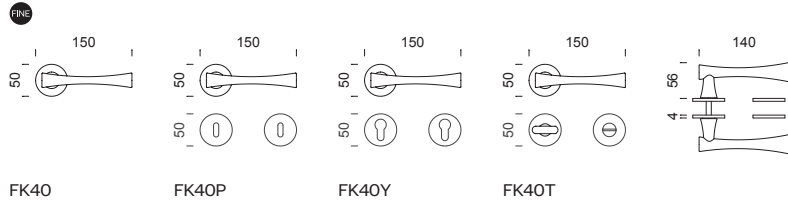

FK40

FK40P

FK40Y

FK40T

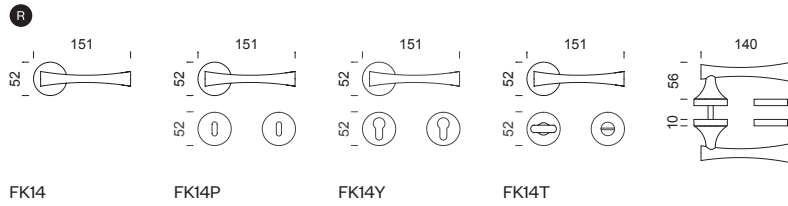

FK14

FK14P

FK14Y

FK14T

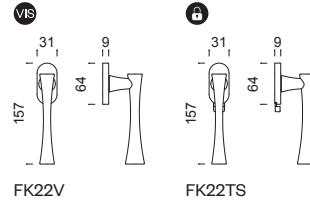

FK22V

FK22TS

fluò

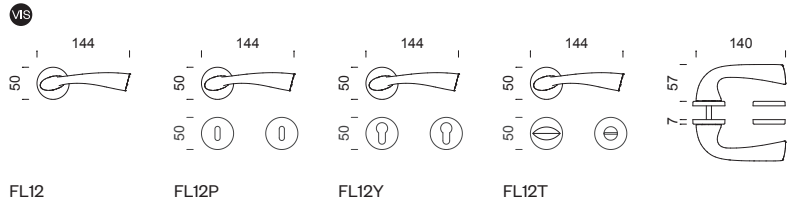

FL12

FL12P

FL12Y

FL12T

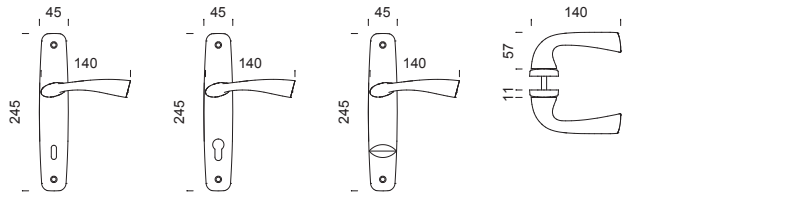

FL10P

FL10Y

FL10T

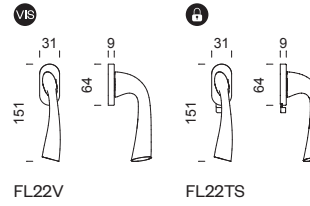

FL22V

FL22TS

fold

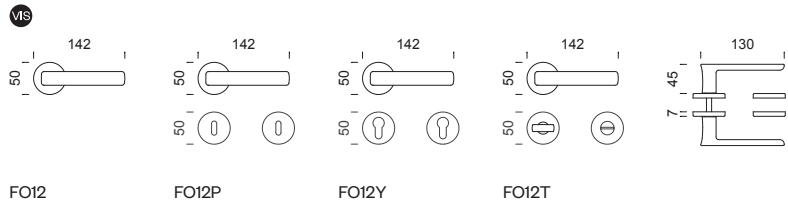

FO12

FO12P

FO12Y

FO12T

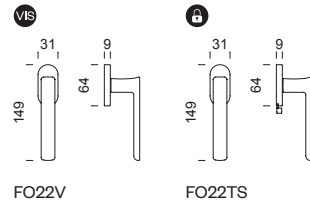

FO22V

FO22TS

fold 02

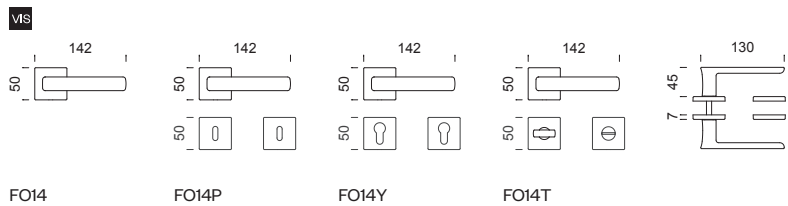

FO14

FO14P

FO14Y

FO14T

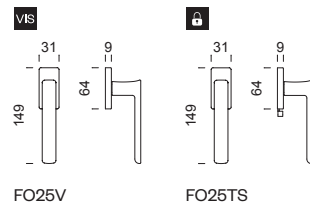

FO25V

FO25TS

freely

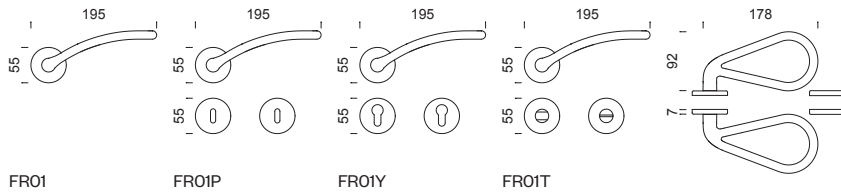

FR01 FR01P FR01Y FR01T

ginevra

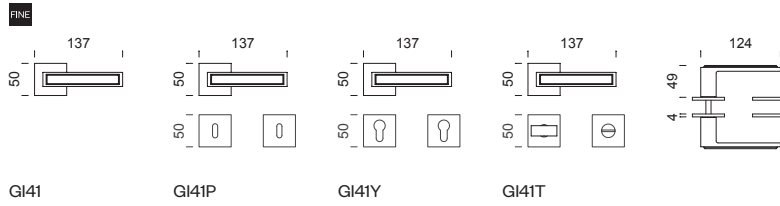

GI41 GI41P GI41Y GI41T

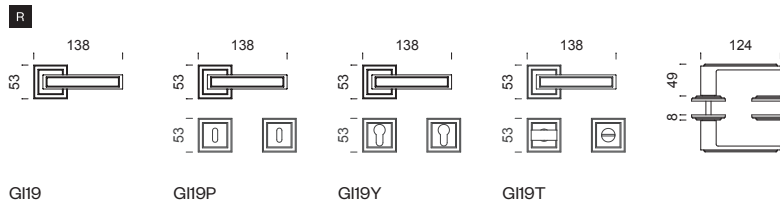

GI19 GI19P GI19Y GI19T

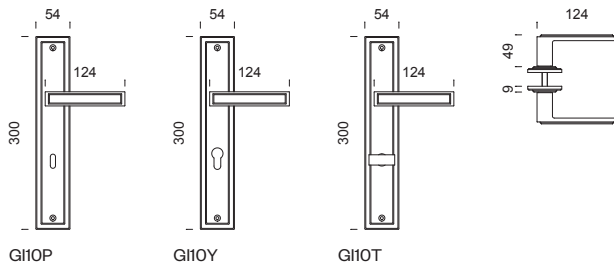

GI10P GI10Y GI10T

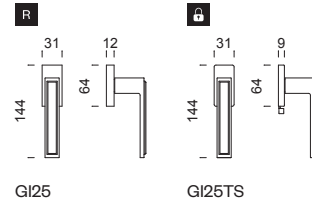

GI25 GI25TS

ginkgo

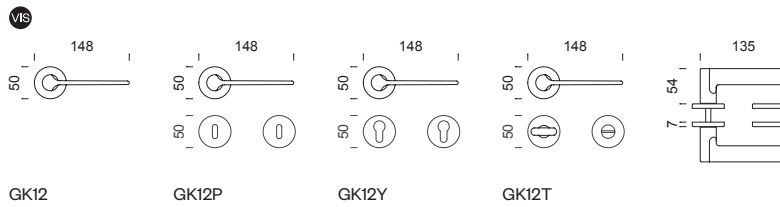

GK12 GK12P GK12Y GK12T

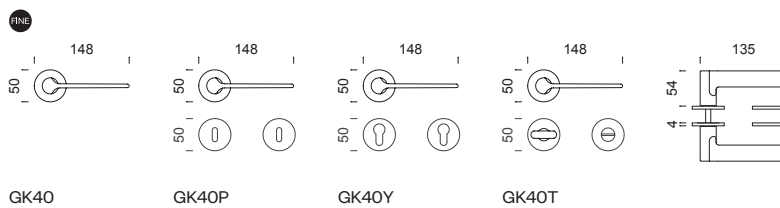

GK40 GK40P GK40Y GK40T

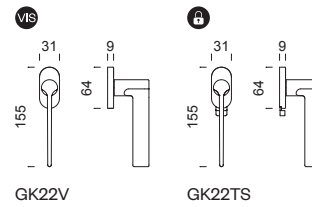

GK22V GK22TS

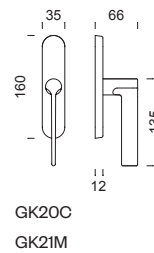

GK20C
GK21M

ginkgo

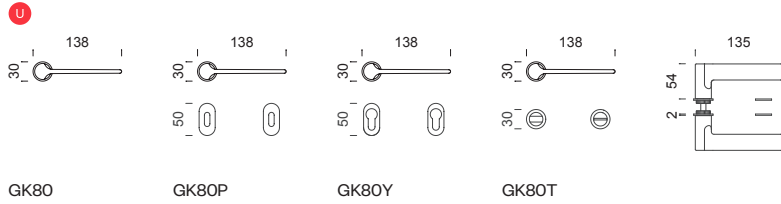

ginkgo biloba

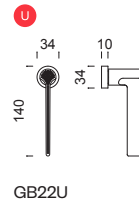
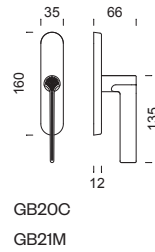
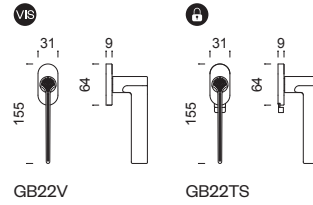
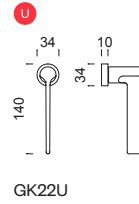
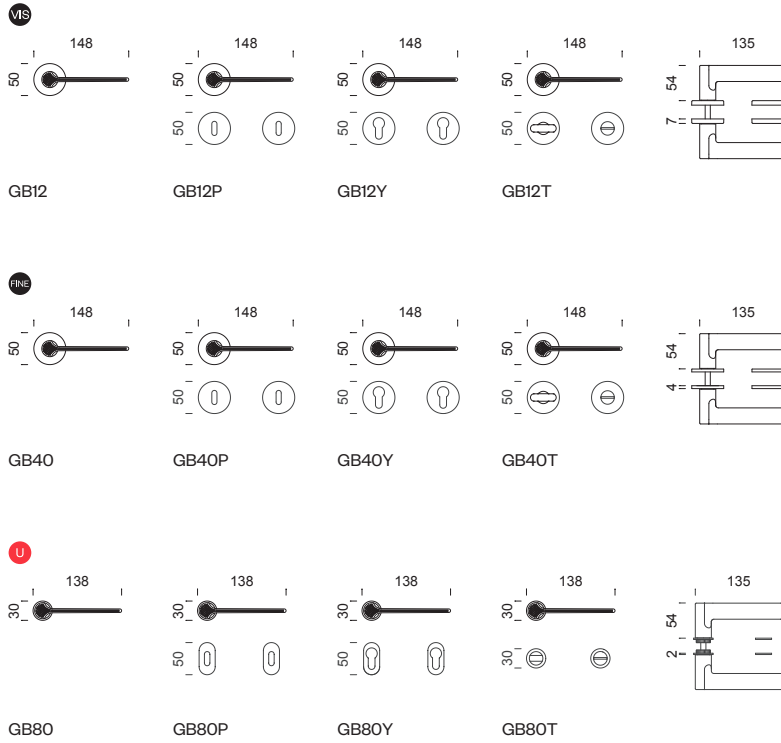

go

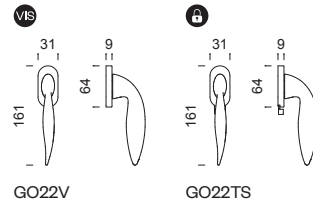
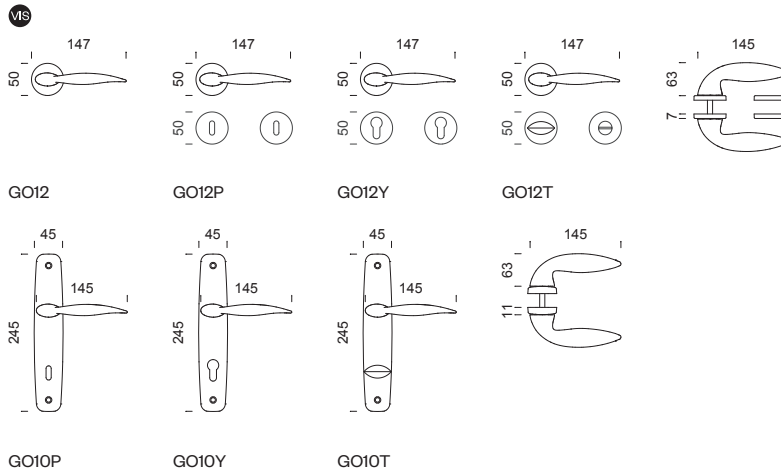

havana

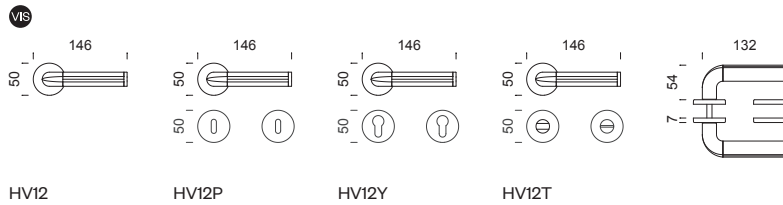

HV12

HV12P

HV12Y

HV12T

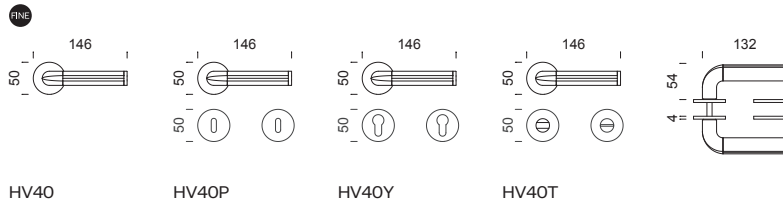

HV40

HV40P

HV40Y

HV40T

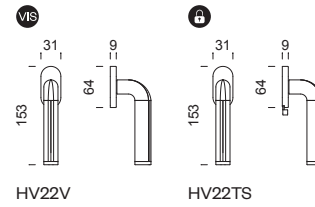

HV22V

HV22TS

holly

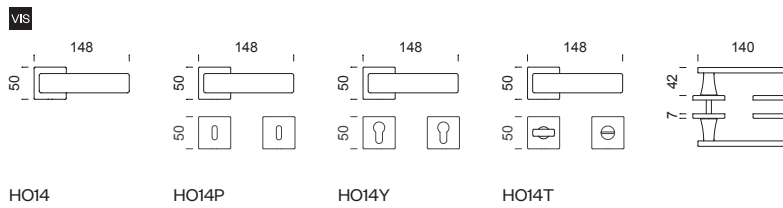

HO14

HO14P

HO14Y

HO14T

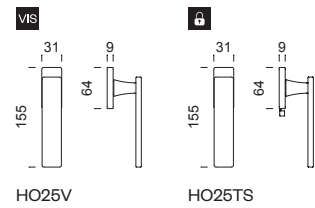

HO25V

HO25TS

iki

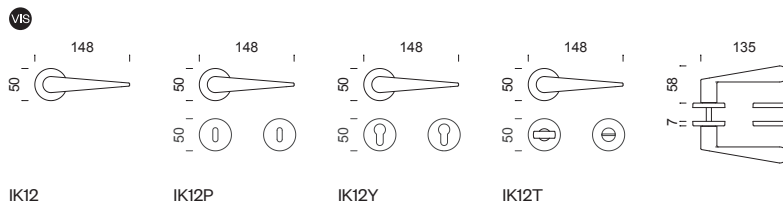

IK12

IK12P

IK12Y

IK12T

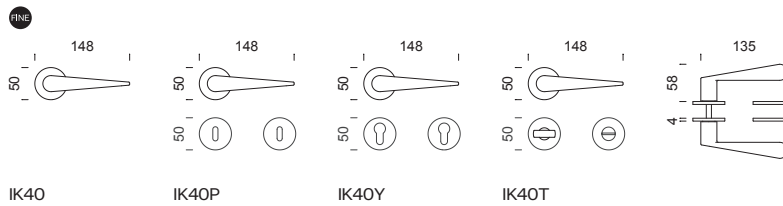

IK40

IK40P

IK40Y

IK40T

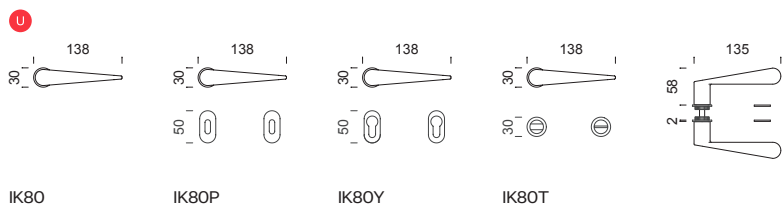

IK80

IK80P

IK80Y

IK80T

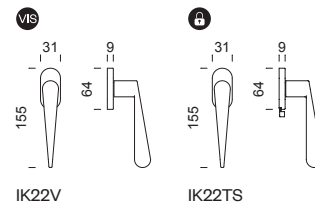

IK22V

IK22TS

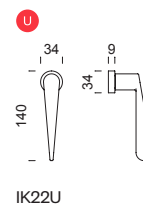

IK22U

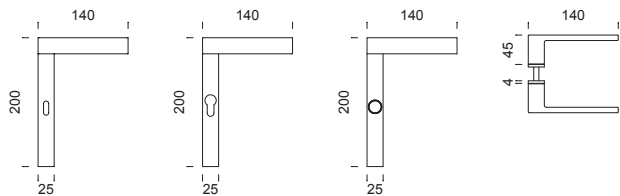

IF10P IF10Y IF10T

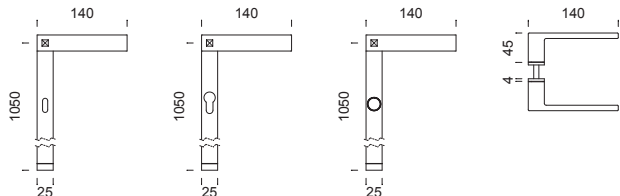

IF10/LP IF10/LY IF10/LT

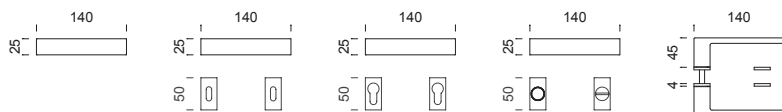

IF01 IF01P IF01Y IF01T

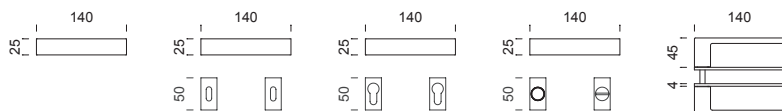

IF11 IF11P IF11Y IF11T

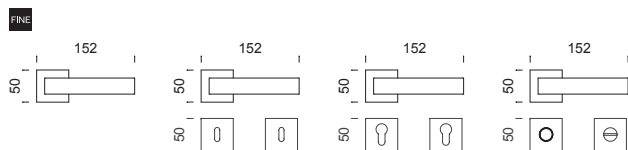

IF41 IF41P IF41Y IF41T

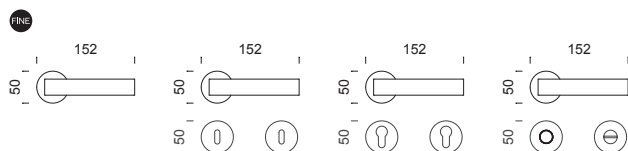

IF40 IF40P IF40Y IF40T

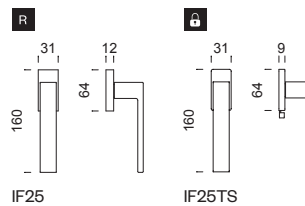

IF25 IF25TS

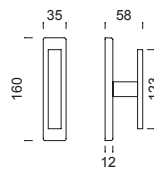

ED26C
ED26M

intake

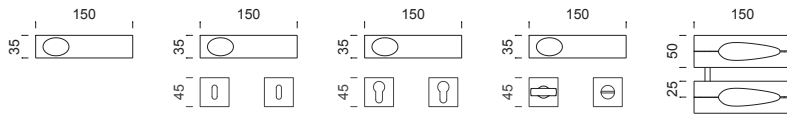

INI4 INI4P INI4Y INI4T

isabella

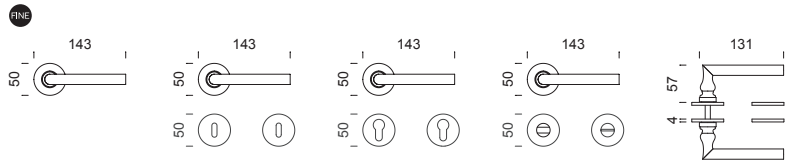

IS40 IS40P IS40Y IS40T

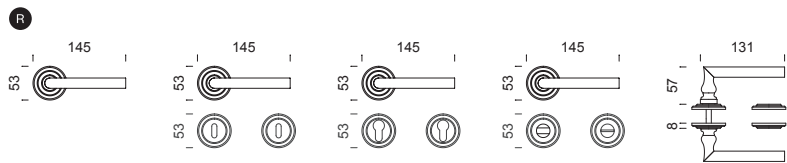

IS13 IS13P IS13Y IS13T

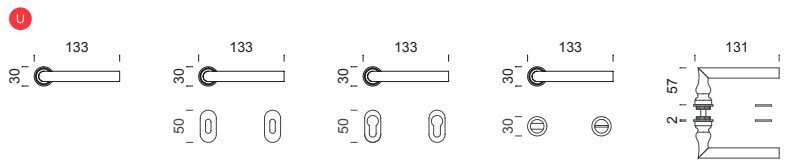

IS80 IS80P IS80Y IS80T

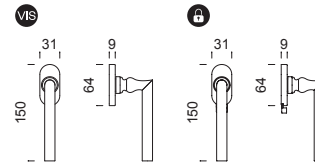

IS22TS

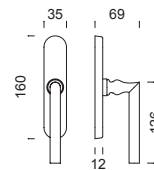

IS20C
IS21M

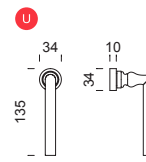

IS22U

joy

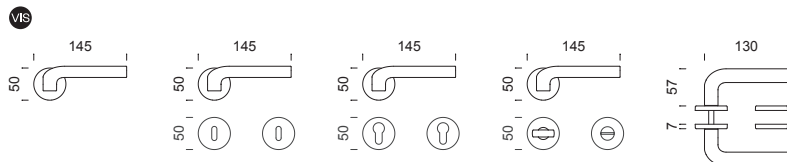

JO12 JO12P JO12Y JO12T

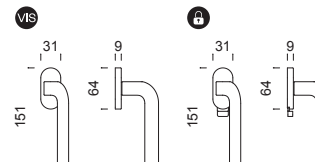

JO22V JO22TS

joy 02

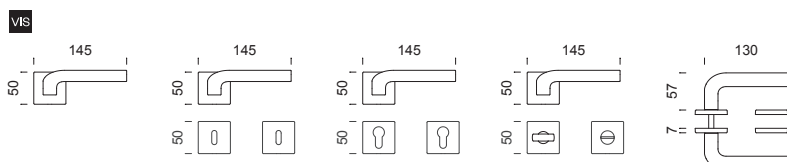

JO14 JO14P JO14Y JO14T

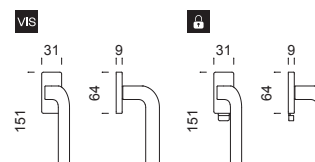

JO25V JO25TS

lady

VIS

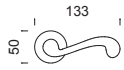

568/12

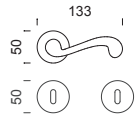

568/12P

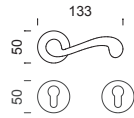

568/12Y

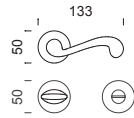

568/12T

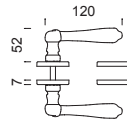

B

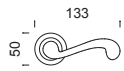

568/B

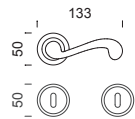

568/BP

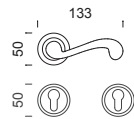

568/BY

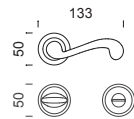

568/BT

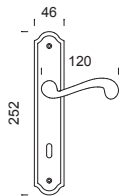
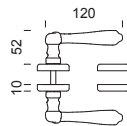

567P

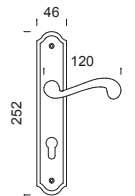

567Y

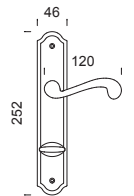

567T

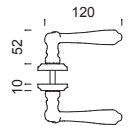

VIS

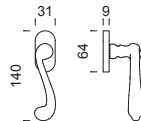

565V

LA

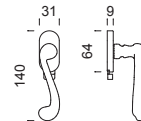

565TS

latina

VIS

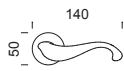

823/12

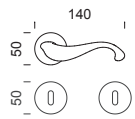

823/12P

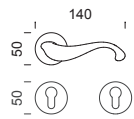

823/12Y

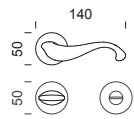

823/12T

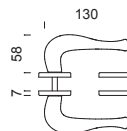

R



824

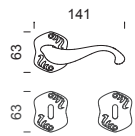

824P

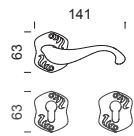

824Y

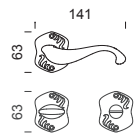

824T

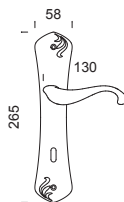
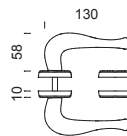

820P

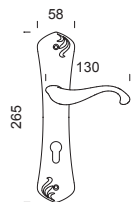

820Y

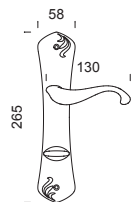

820T

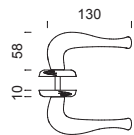

VIS

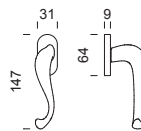

829V

LA

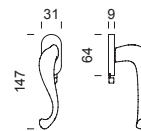

829TS

leva NEW

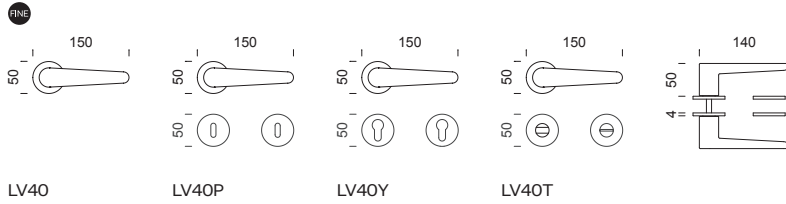

LV40 LV40P LV40Y LV40T

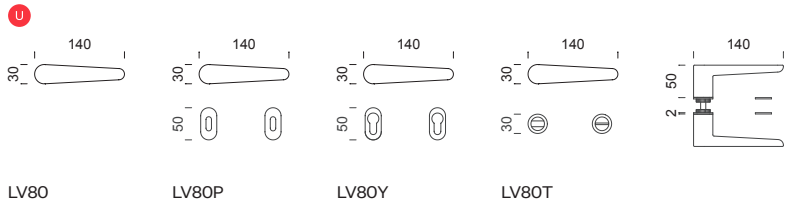

LV80 LV80P LV80Y LV80T

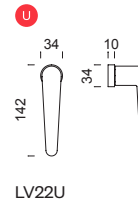

LV22U

leva mirror NEW

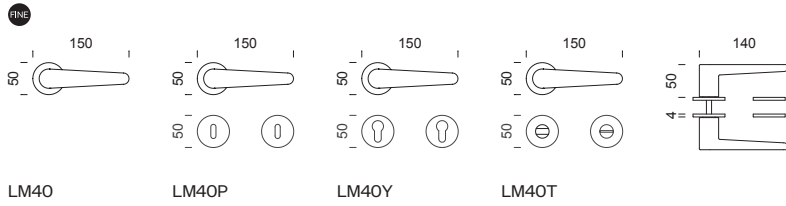

LM40 LM40P LM40Y LM40T

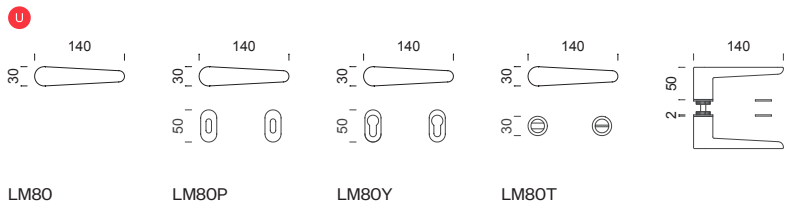

LM80 LM80P LM80Y LM80T

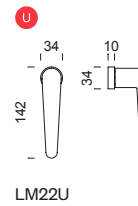

LM22U

levante

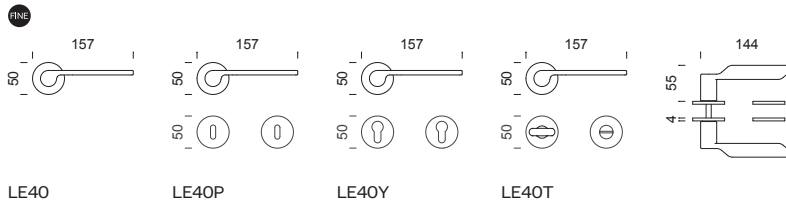

LE40 LE40P LE40Y LE40T

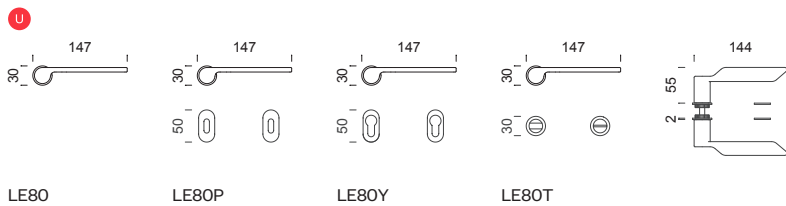

LE80 LE80P LE80Y LE80T

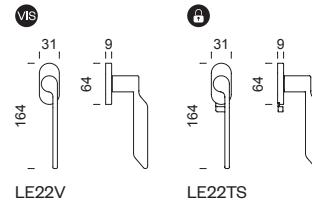

LE22V LE22TS

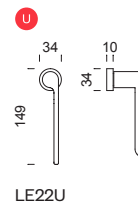

LE22U

linear

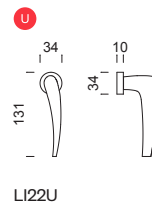
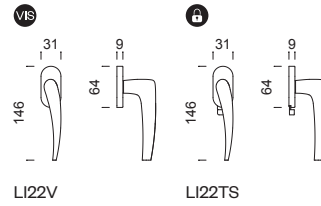
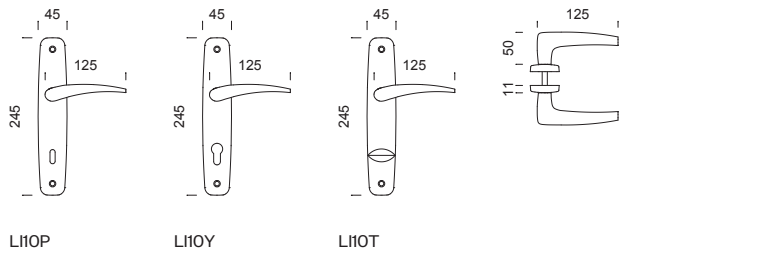
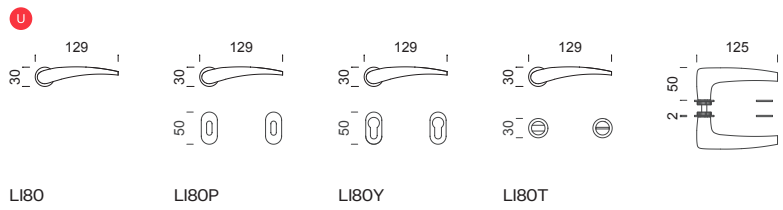
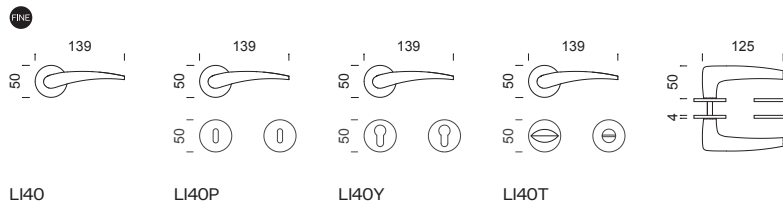
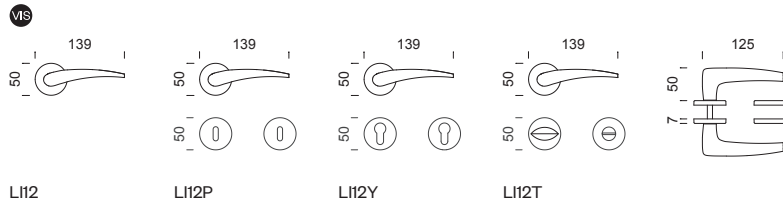

link

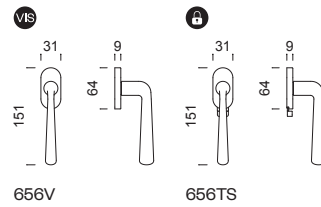
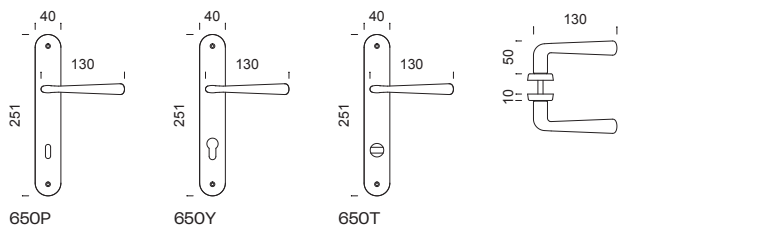
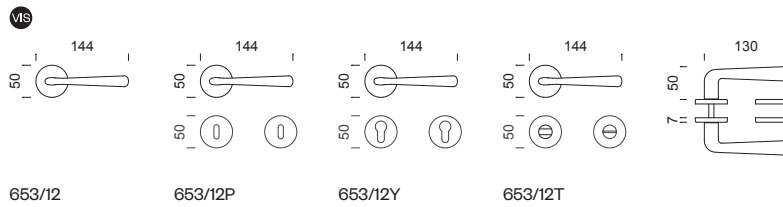

lirica

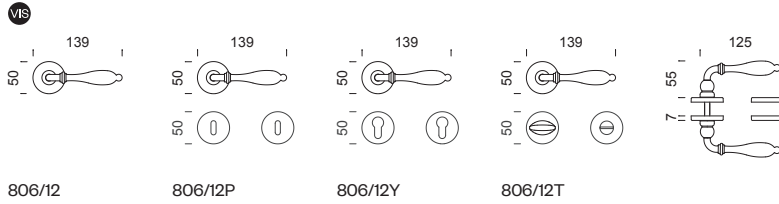

806/12 806/12P 806/12Y 806/12T

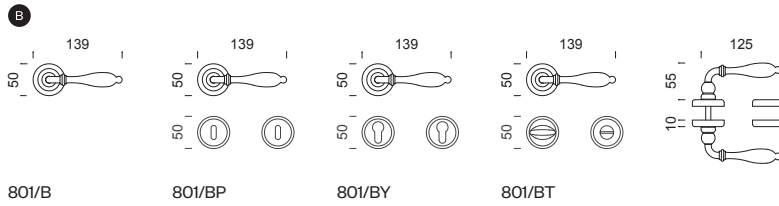

801/B 801/BP 801/BY 801/BT

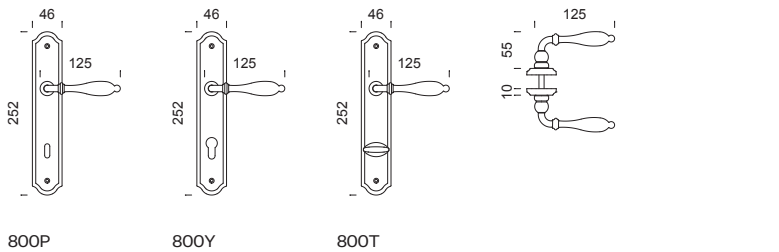

800P 800Y 800T

lorena

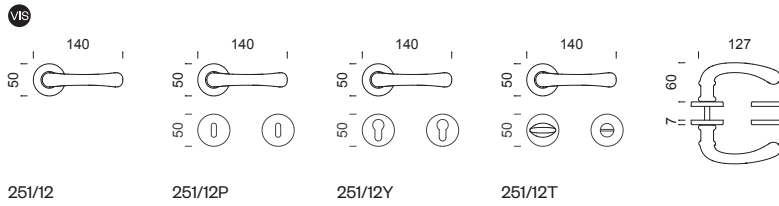

251/12 251/12P 251/12Y 251/12T

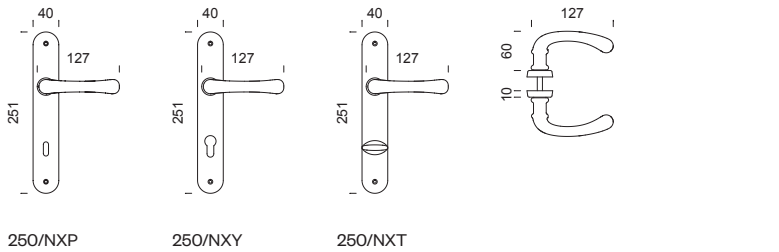

250/NXP 250/NXY 250/NXT

luce

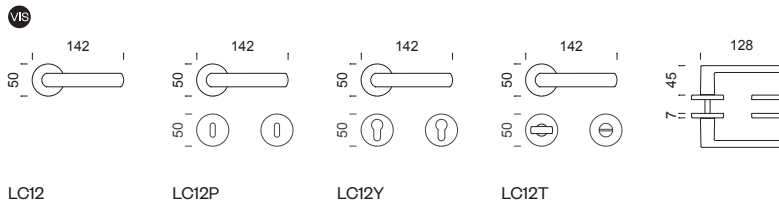

LC12 LC12P LC12Y LC12T

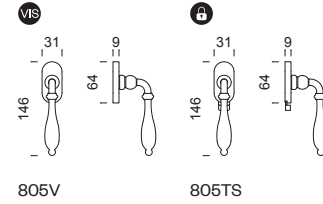

805V 805TS

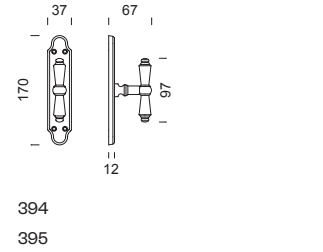

394
395

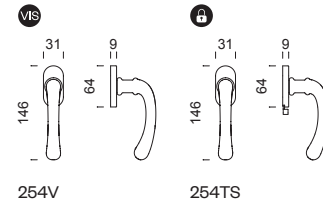

254V 254TS

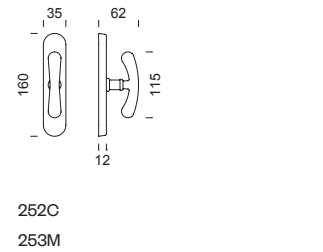

252C
253M

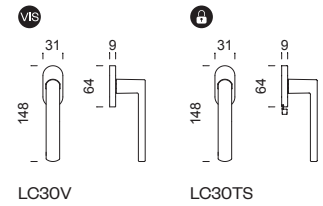

LC30V LC30TS

luce

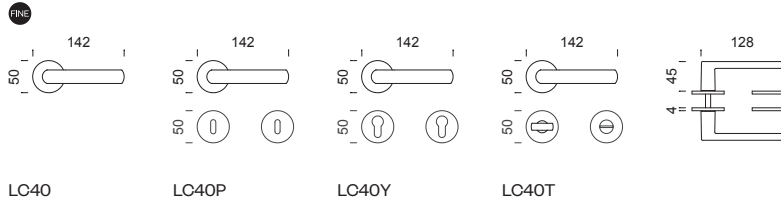

LC40 LC40P LC40Y LC40T

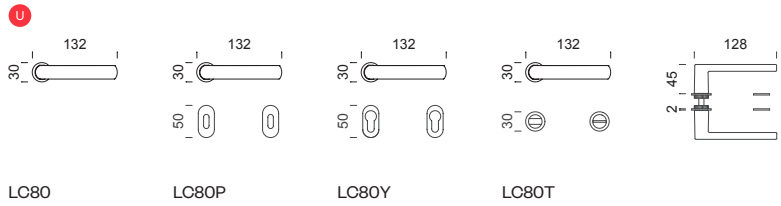

LC80 LC80P LC80Y LC80T

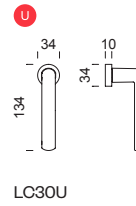

LC30U

luce 02

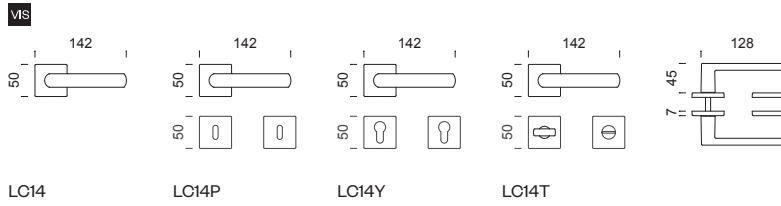

LC14 LC14P LC14Y LC14T

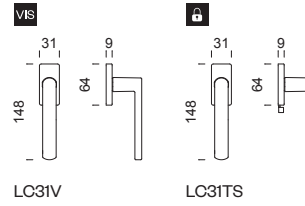

LC31V LC31TS

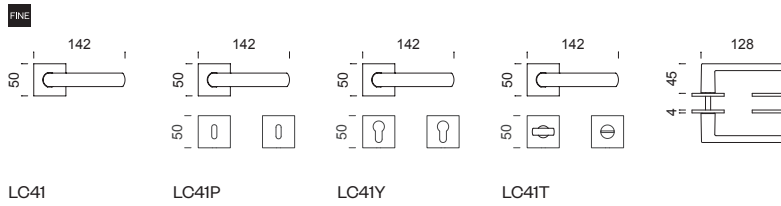

LC41 LC41P LC41Y LC41T

luce p

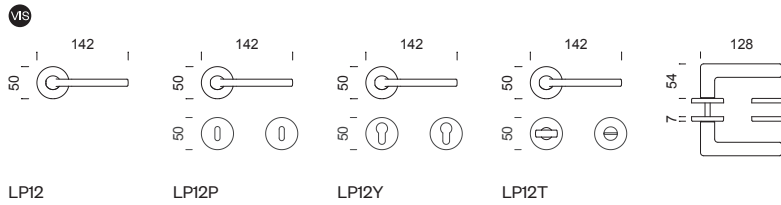

LP12 LP12P LP12Y LP12T

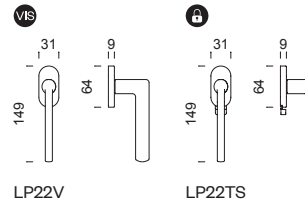

LP22V LP22TS

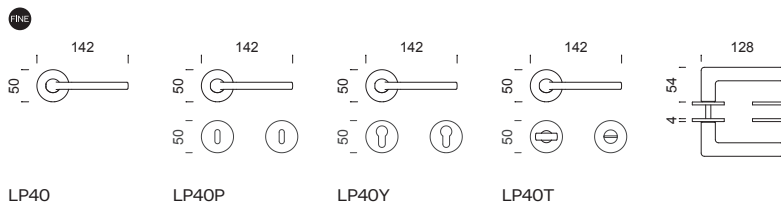

LP40 LP40P LP40Y LP40T

luce p

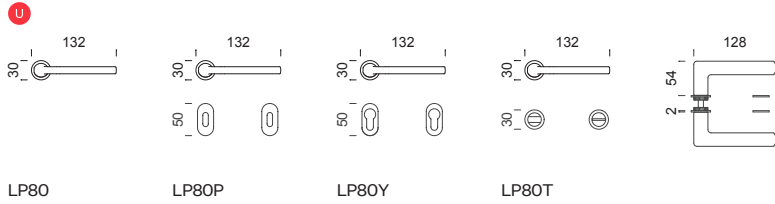

luce p 02

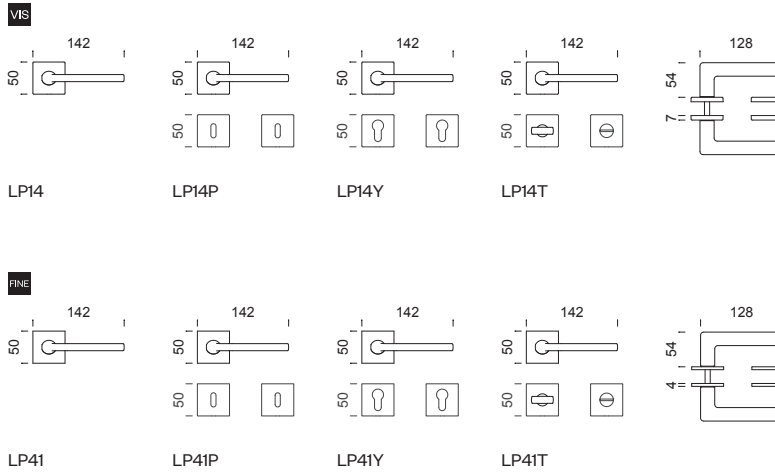

lucrezia

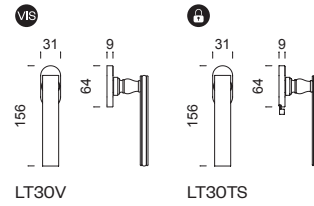
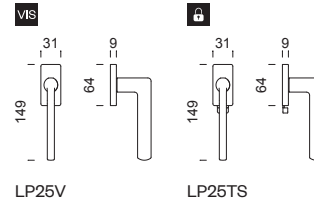
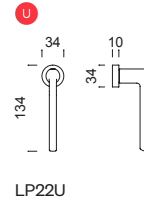
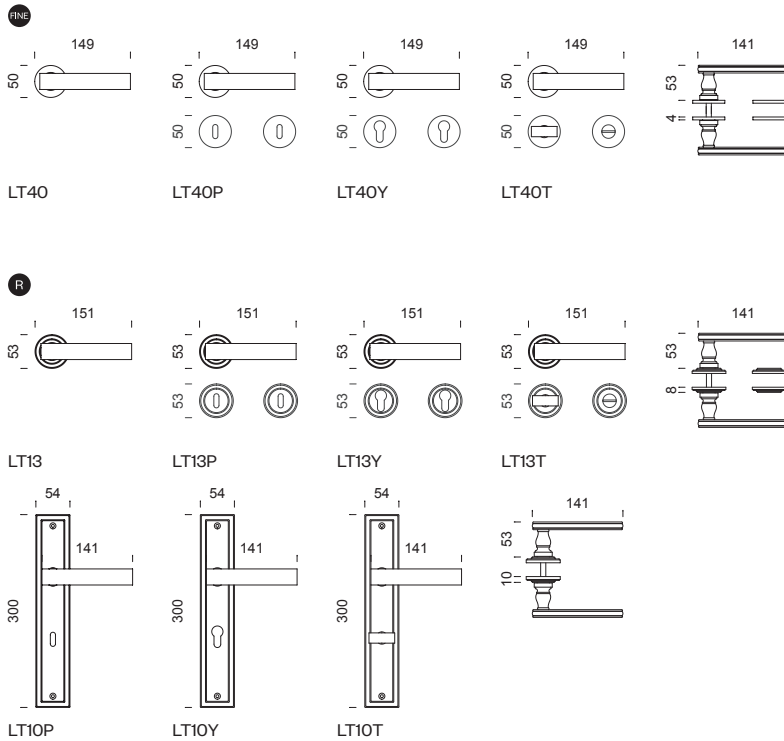

lucrezia O2

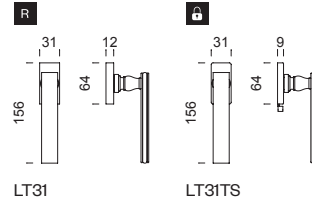
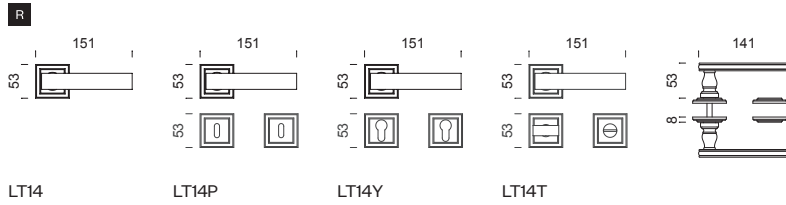
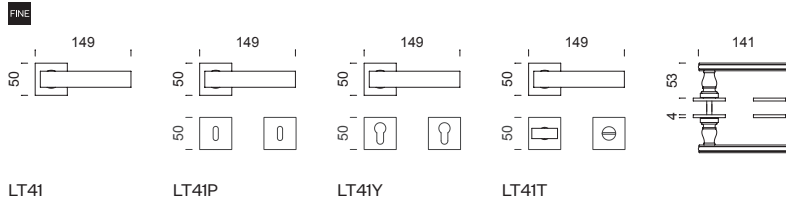

luxury

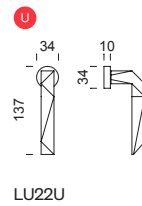
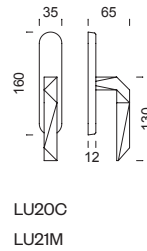
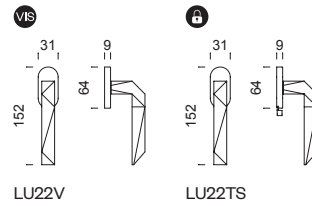
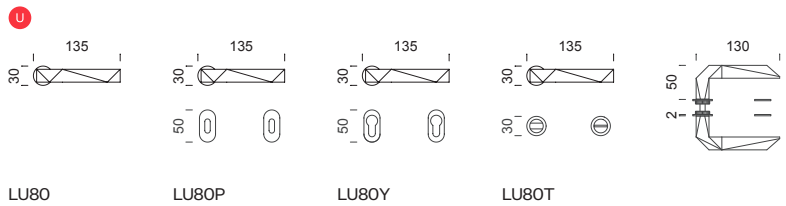
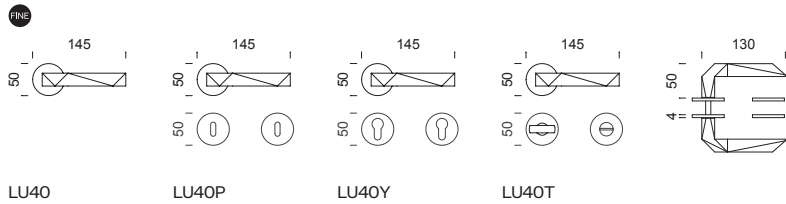
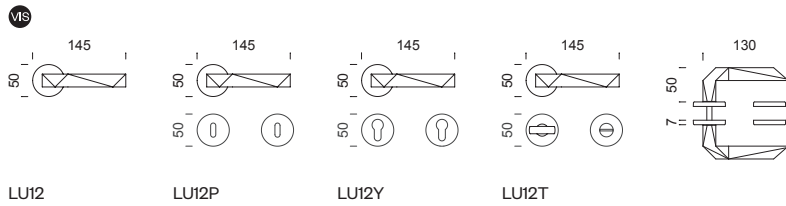

luxury O2

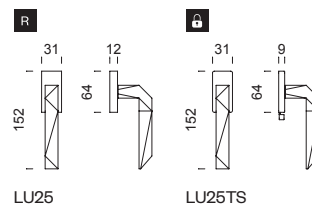
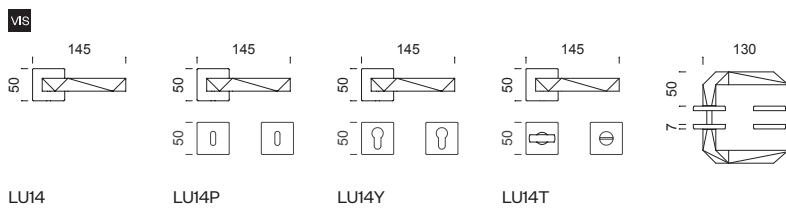

luxury 02

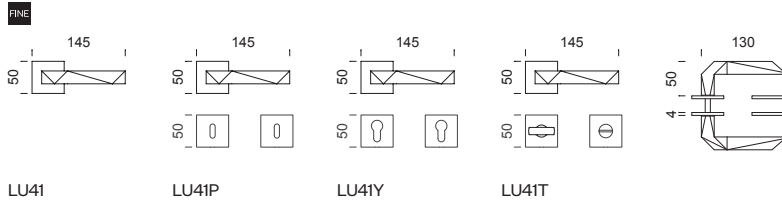

LU23C
LU24M

madeleine

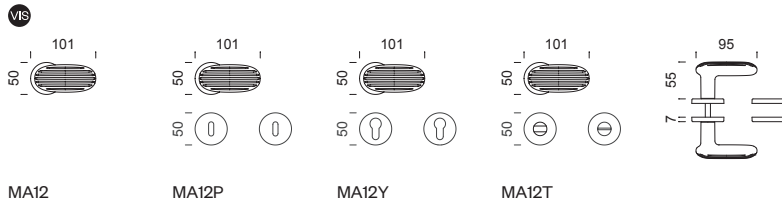

MA12 MA12P MA12Y MA12T

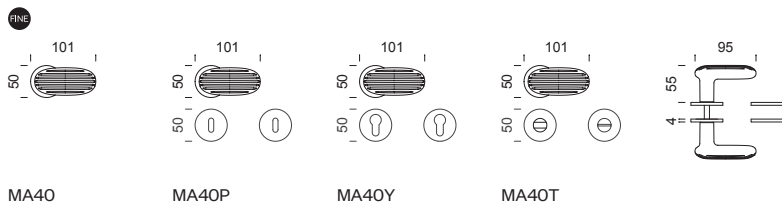

MA40 MA40P MA40Y MA40T

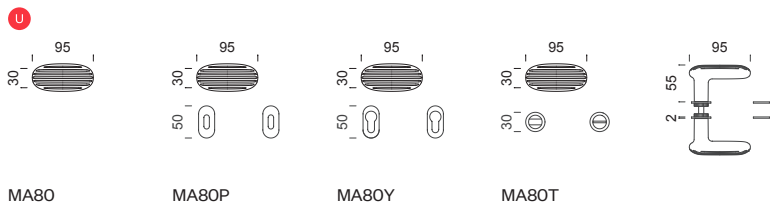

MA80 MA80P MA80Y MA80T

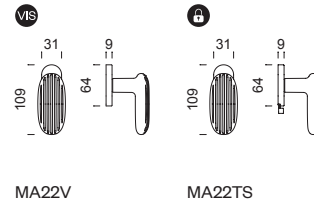

MA22V MA22TS

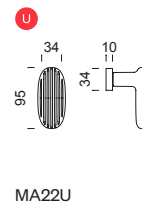

MA22U

minima

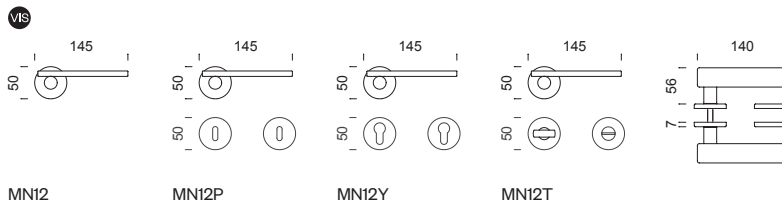

MN12 MN12P MN12Y MN12T

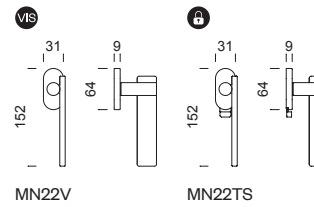

MN22V MN22TS

mix

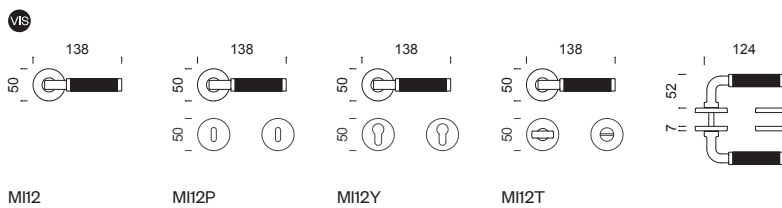

MI12 MI12P MI12Y MI12T

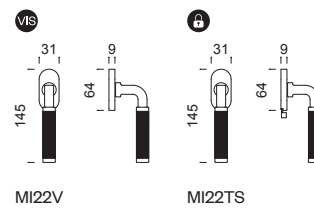

MI22V MI22TS

mj

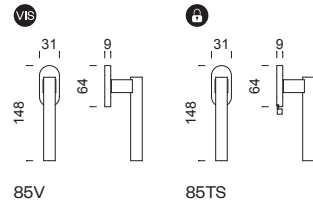
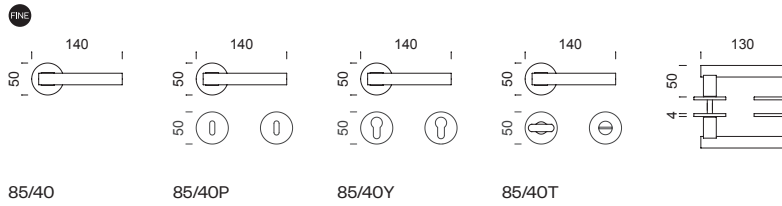

nova

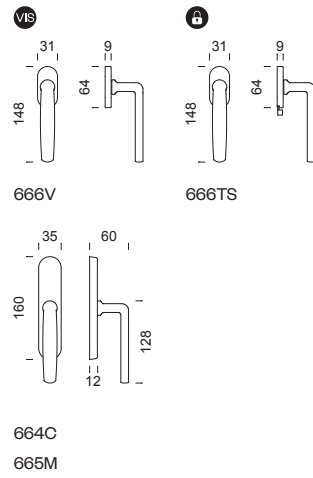
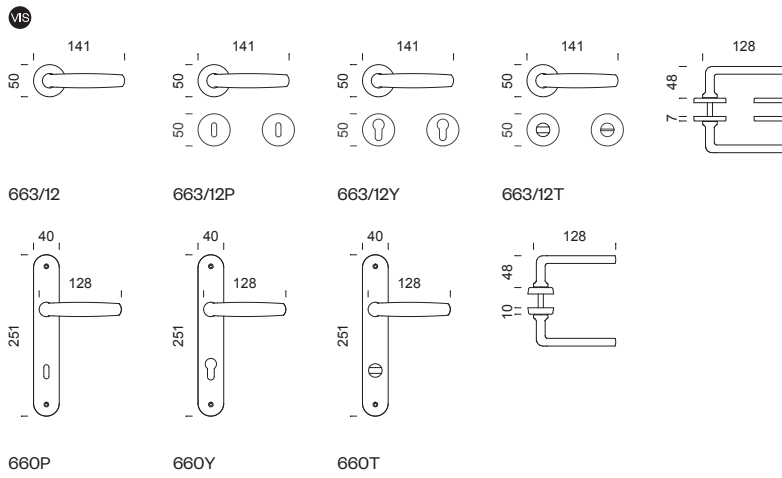

ovum

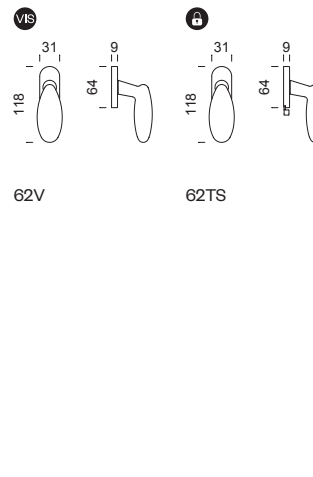
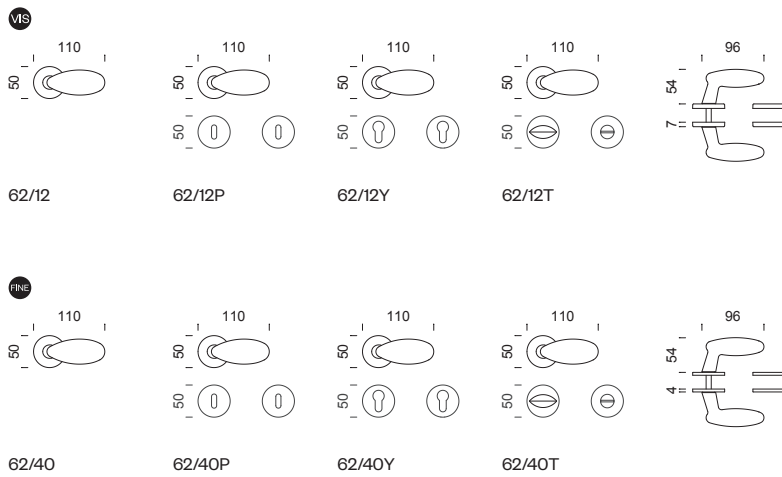

pluris NEW

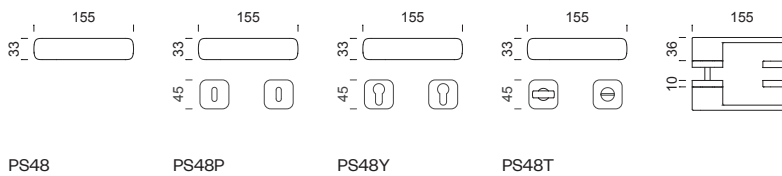

pod

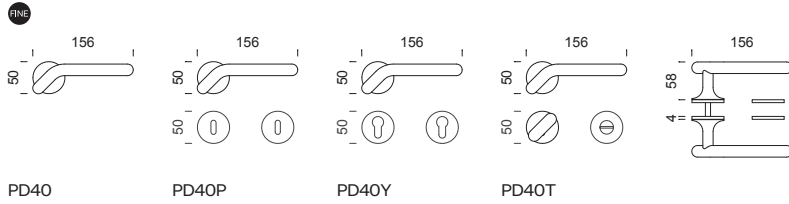

project

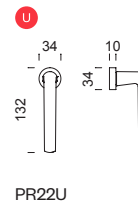
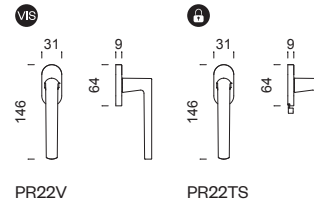
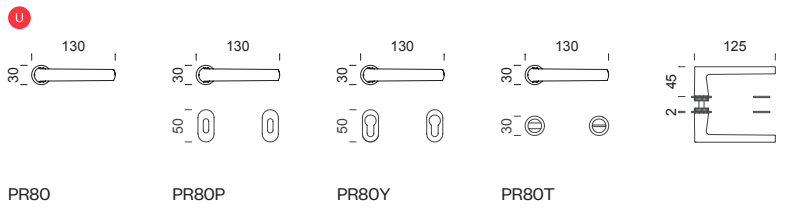
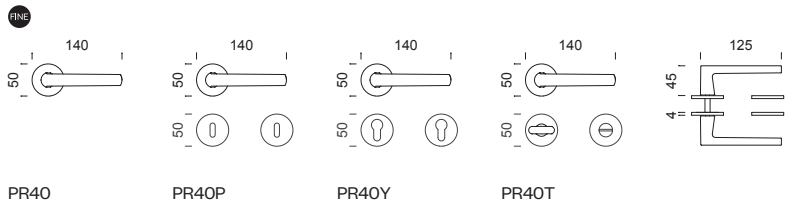
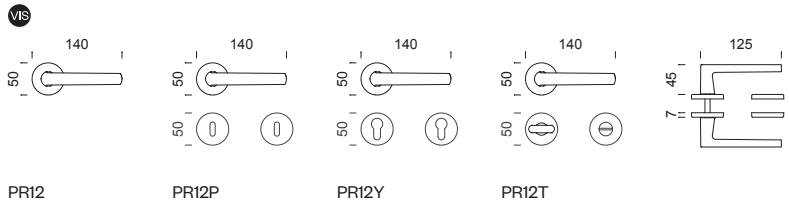

project 02

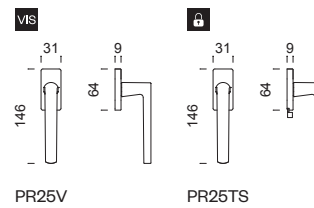
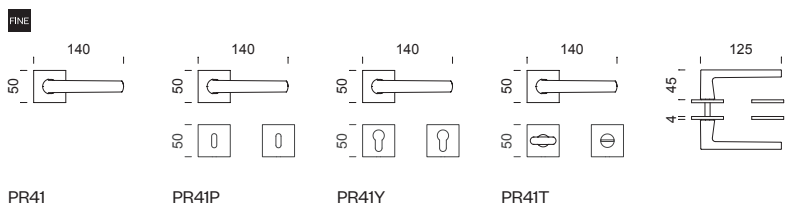
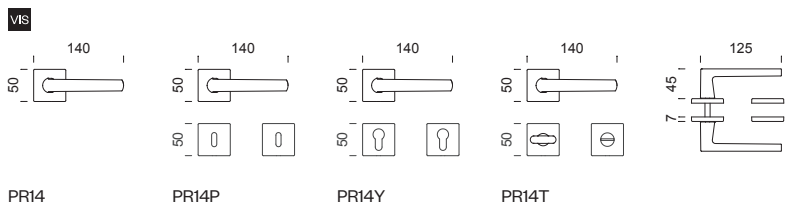

project zancata

VIS

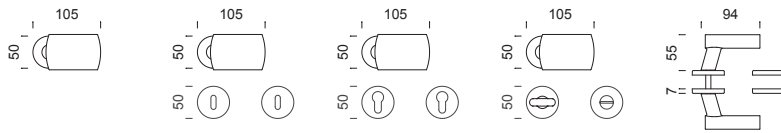

PO12

PO12P

PO12Y

PO12T

project zancata 02

VIS

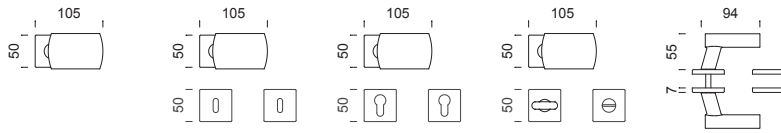

PO14

PO14P

PO14Y

PO14T

quattro 02

VIS

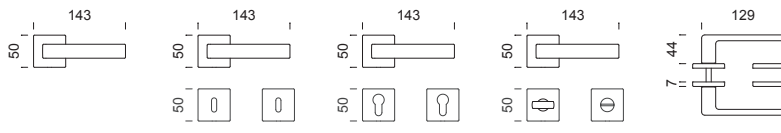

264/14-Z

264/14-ZP

264/14-ZY

264/14-ZT

VIS

LOCK

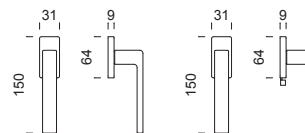

266-ZV

266-ZTS

S40

VIS

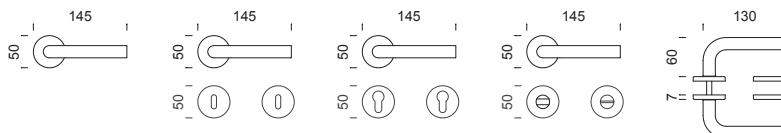

S40/12

S40/12P

S40/12Y

S40/12T

S45

S50

VIS

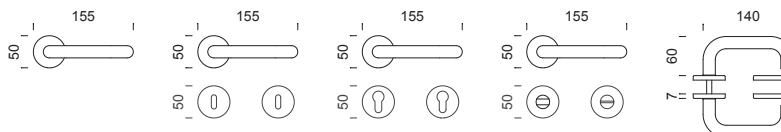

S50/12

S50/12P

S50/12Y

S50/12T

S55

S60

VIS

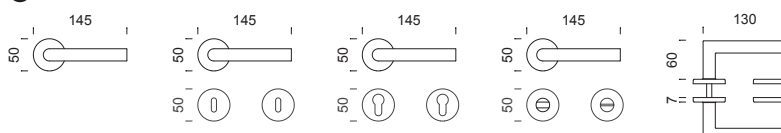

S60/12

S60/12P

S60/12Y

S60/12T

S65

safety

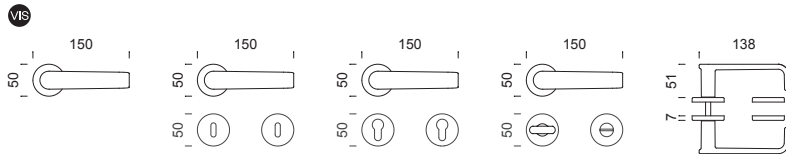

SA12 SA12P SA12Y SA12T

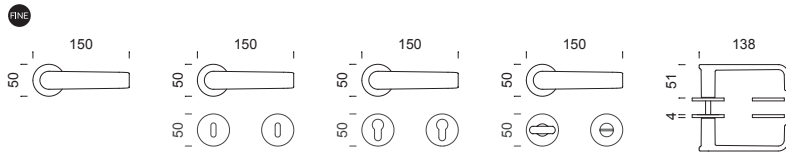

SA40 SA40P SA40Y SA40T

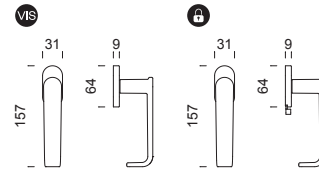

SA22V SA22TS

san

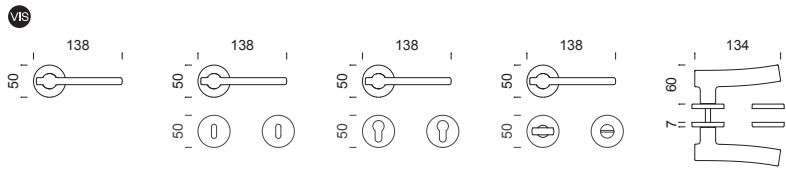

SN12 SN12P SN12Y SN12T

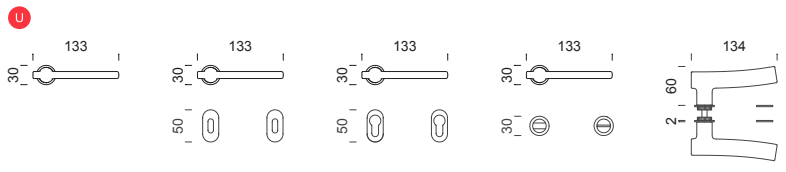

SN80 SN80P SN80Y SN80T

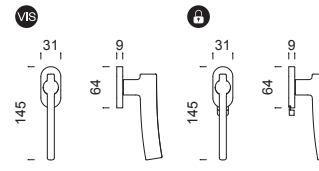

SN22V SN22TS

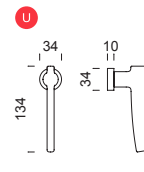

SN22U

san 02

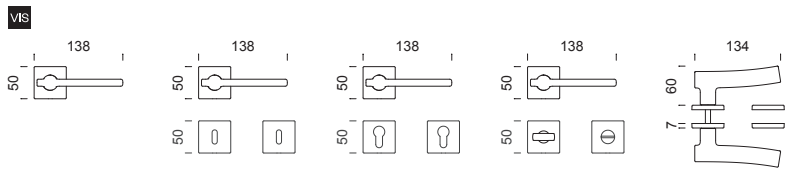

SN14 SN14P SN14Y SN14T

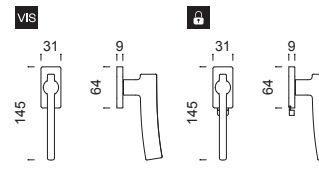

SN25V SN25TS

short

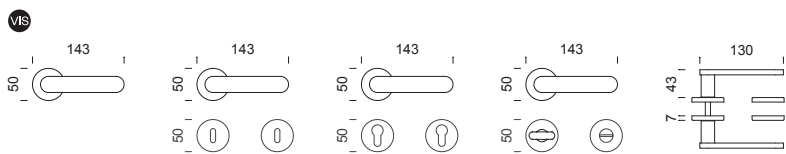

SH12 SH12P SH12Y SH12T

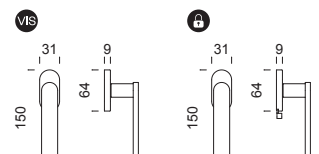

SH22V SH22TS

short

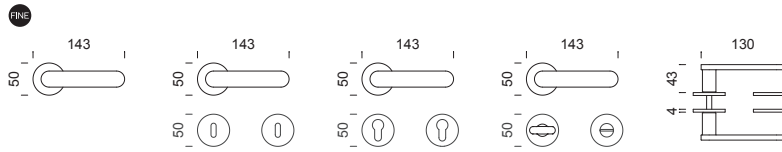

SH40 SH40P SH40Y SH40T

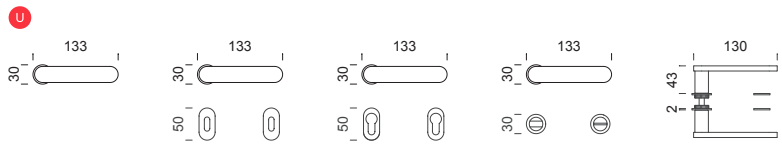

SH80 SH80P SH80Y SH80T

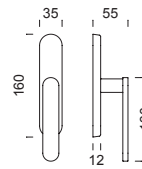

SH20C
SH21M

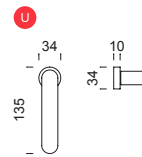

SH22U

sike

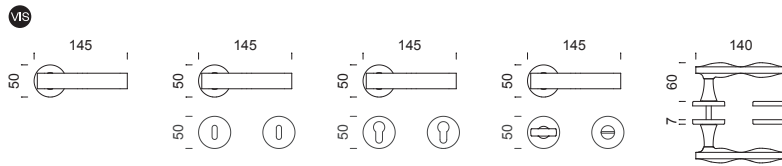

SK12 SK12P SK12Y SK12T

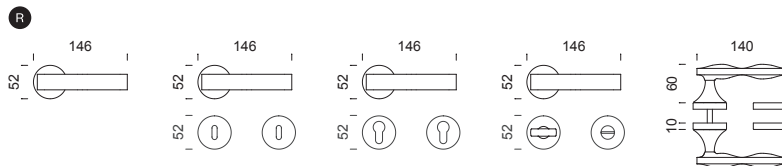

SK14 SK14P SK14Y SK14T

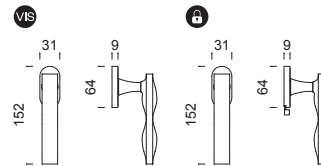

SK22V SK22TS

sike 02

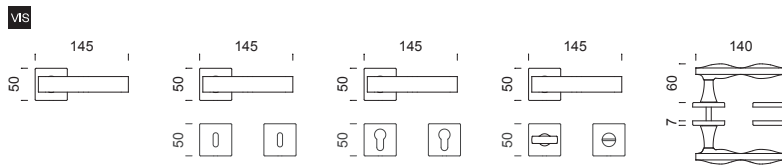

SK13 SK13P SK13Y SK13T

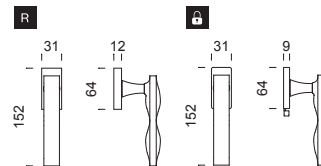

SK25 SK25TS

silvyana

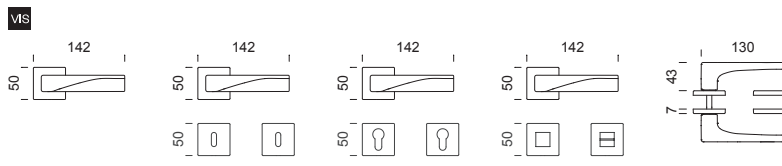

52/14 52/14P 52/14Y 52/14T

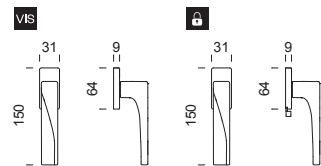

52QV 52QTS

silvana

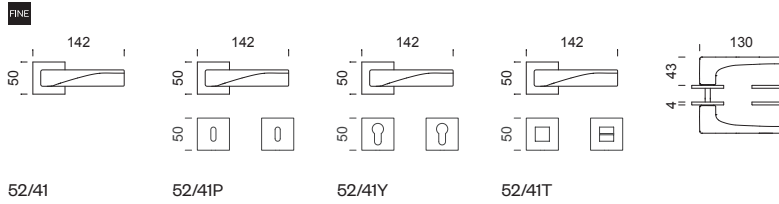

52/41

52/41P

52/41Y

52/41T

sochic

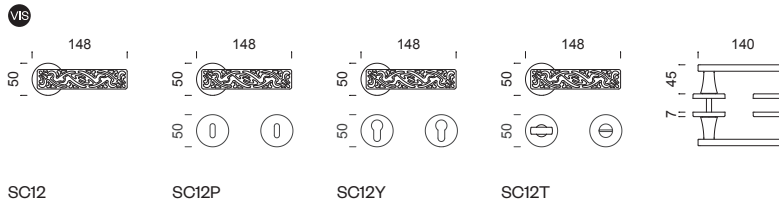

SC12

SC12P

SC12Y

SC12T

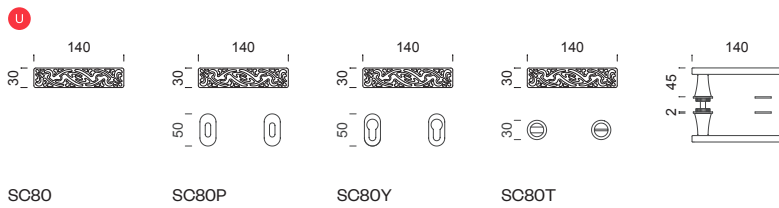

SC80

SC80P

SC80Y

SC80T

sochic O2

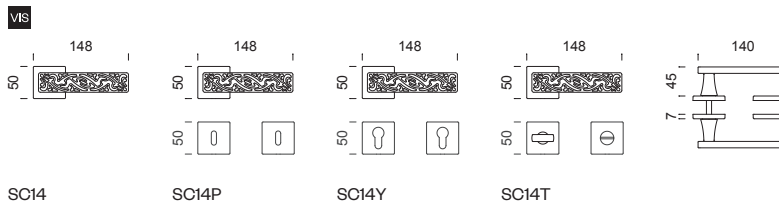

SC14

SC14P

SC14Y

SC14T

sochic L

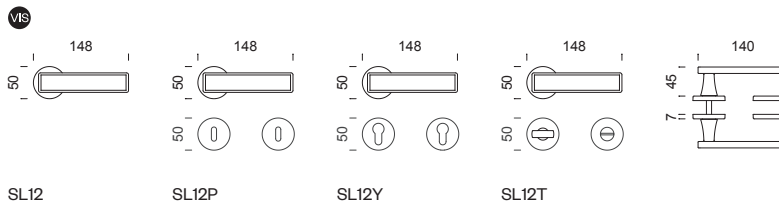

SL12

SL12P

SL12Y

SL12T

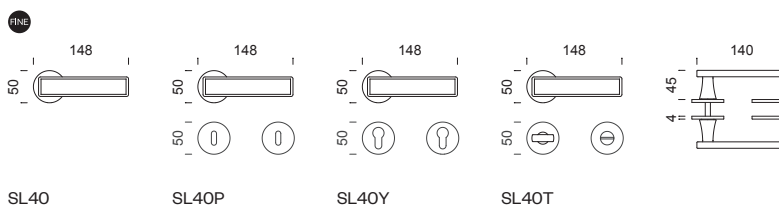

SL40

SL40P

SL40Y

SL40T

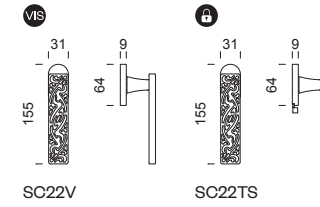

SC22V

SC22TS

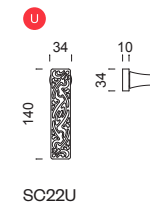

SC22U

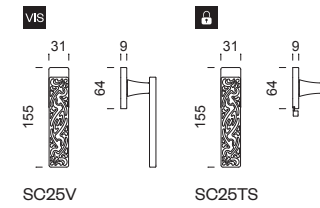

SC25V

SC25TS

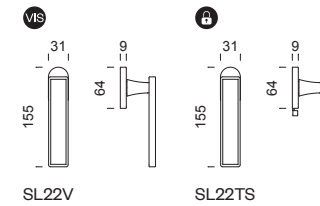

SL22V

SL22TS

sohic L 02

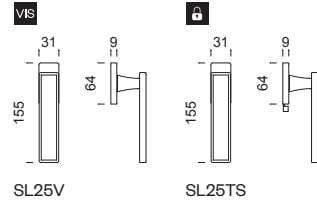
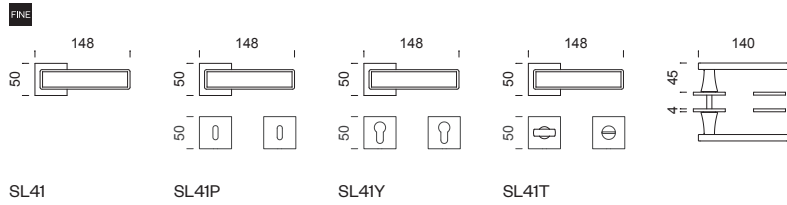
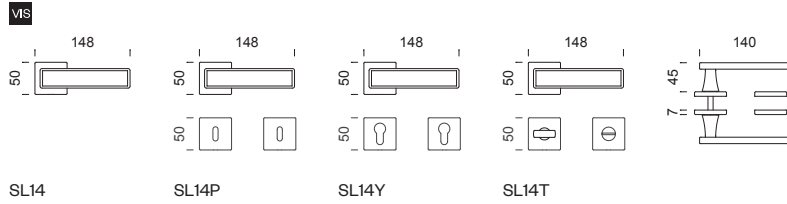

stick 02

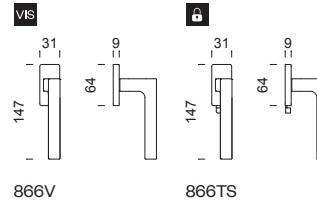
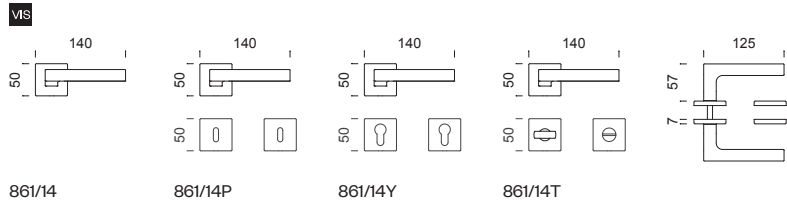

thelma

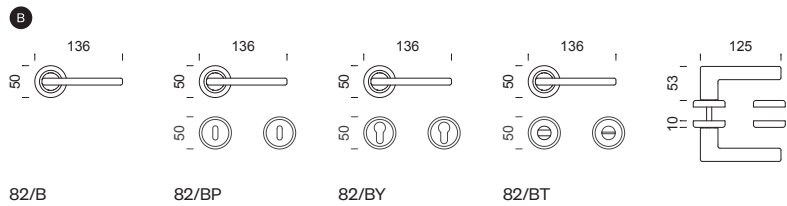
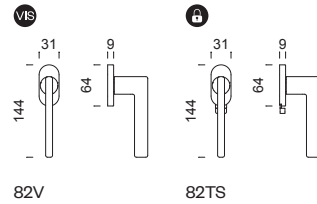
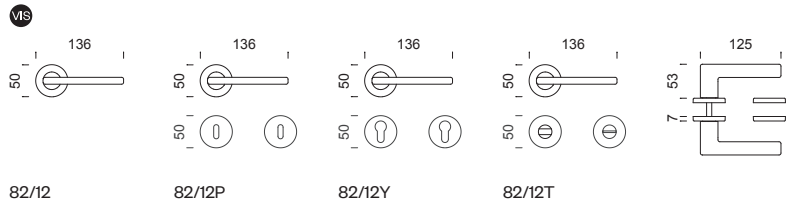

timeless

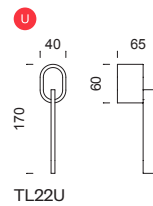
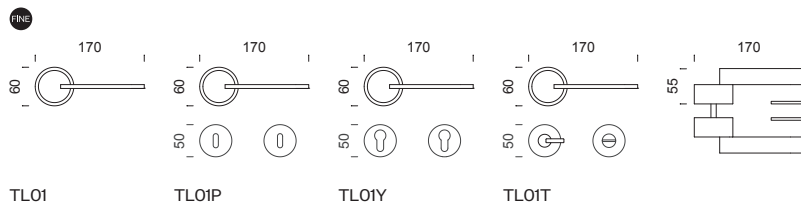

tipo-z

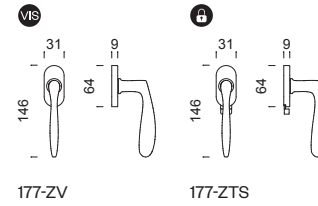
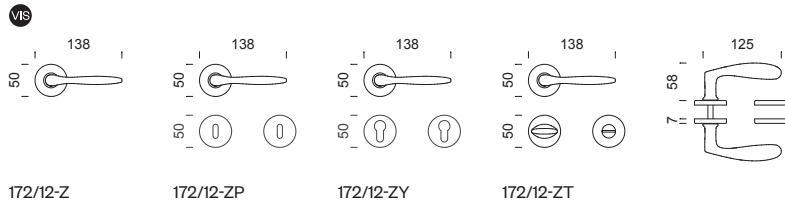

twist

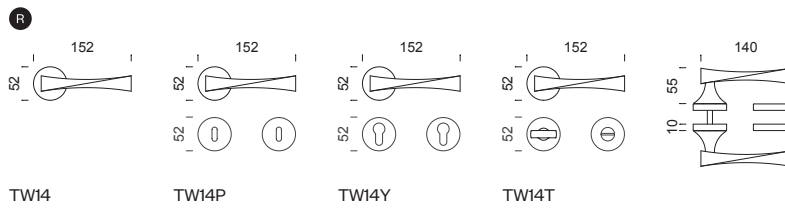
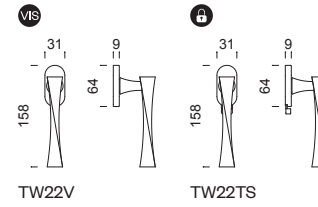
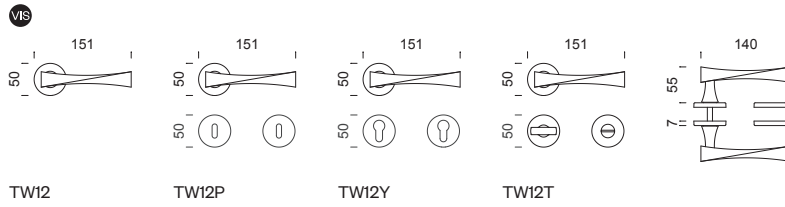

twist 02

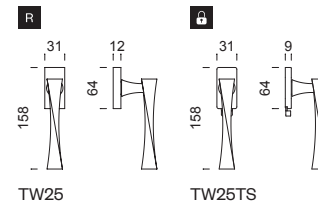
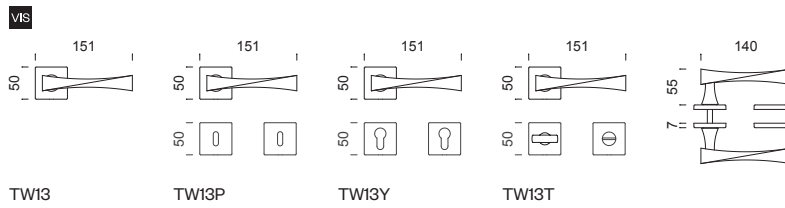

vita

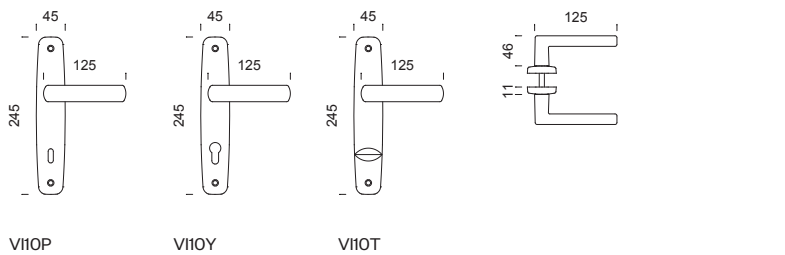
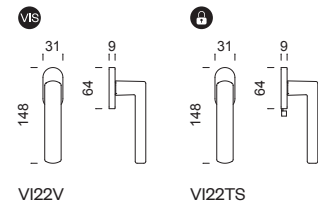
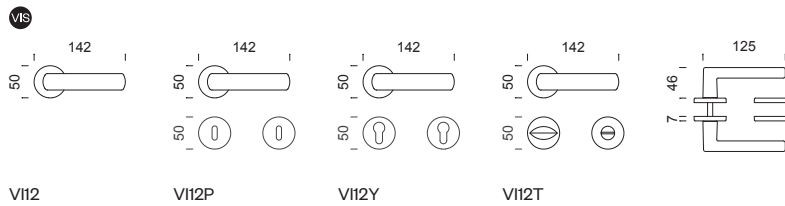

viva!

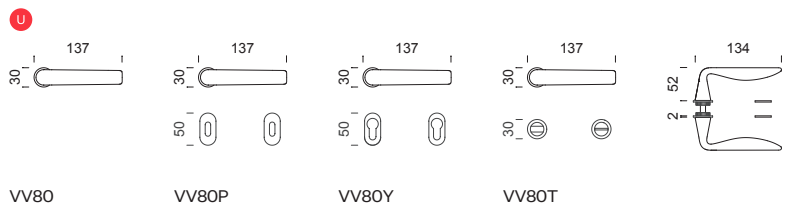
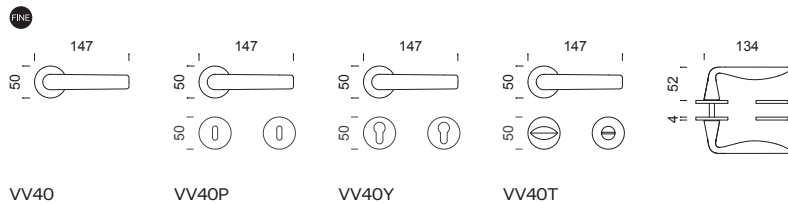
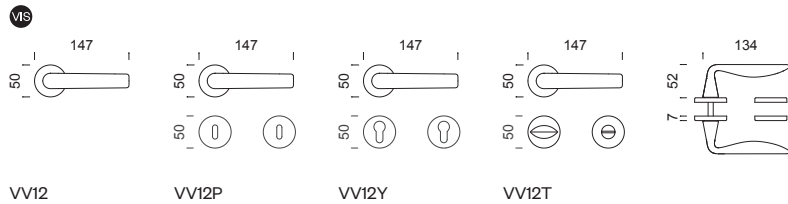

disegni tecnici technical drawings

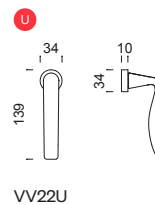
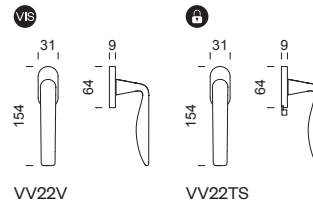

zeppelin

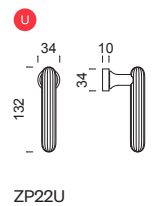
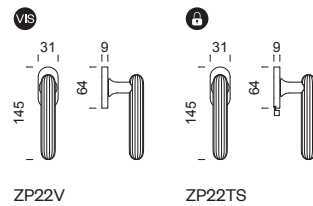
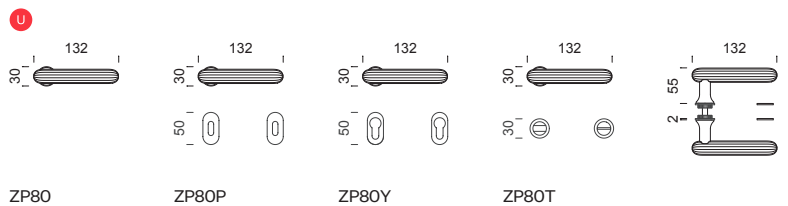
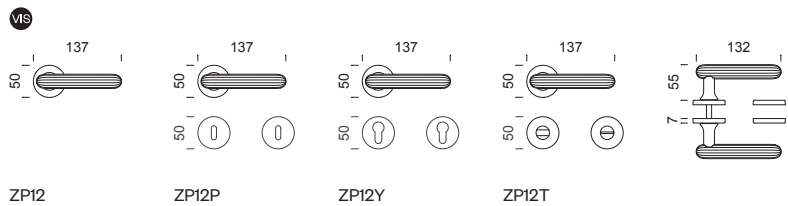

Tutte le quote riportate nel catalogo sono espresse in millimetri
All dimensions in the catalogue are in millimetres

note / notes

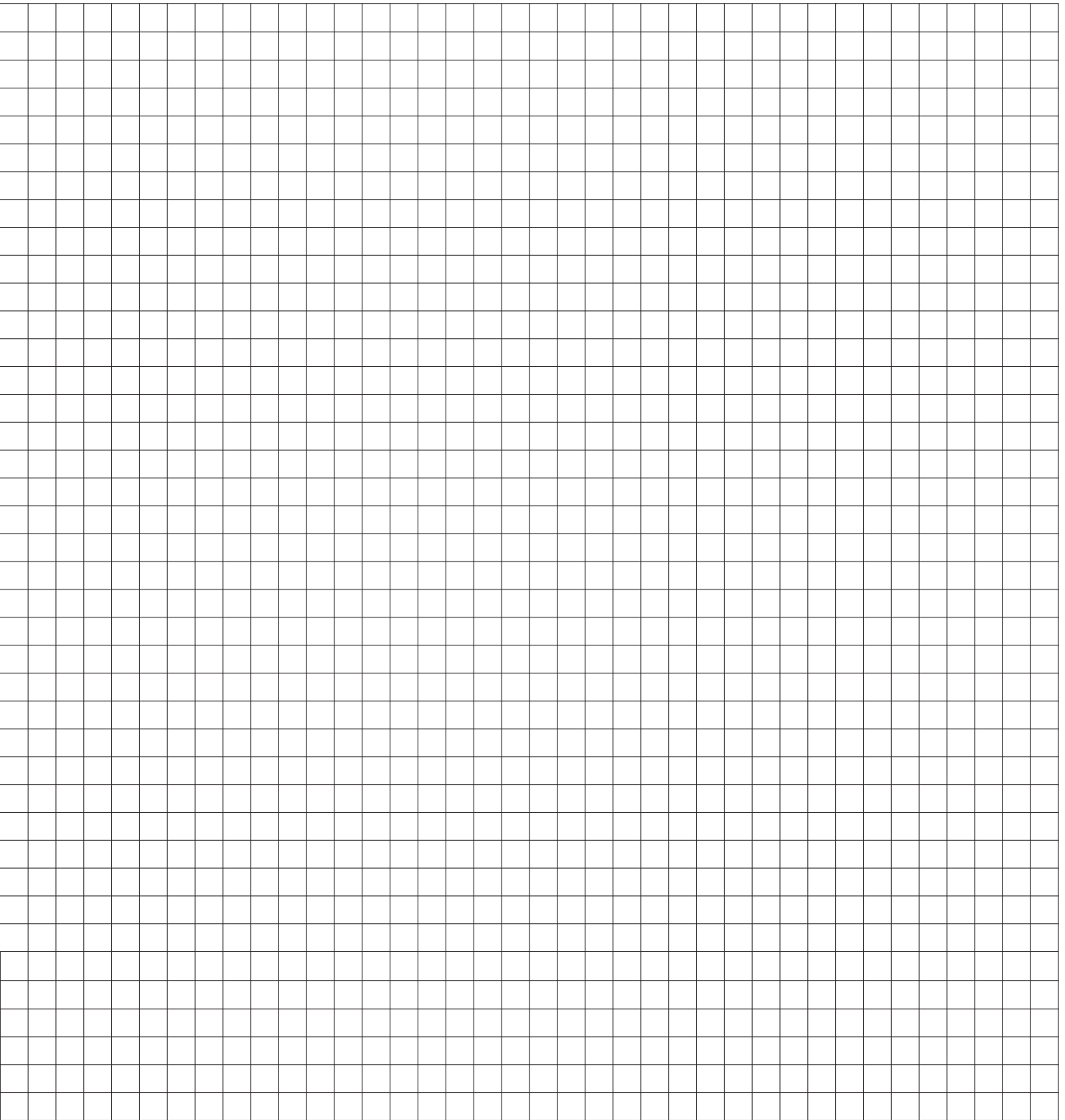

Progetto grafico /
Graphic design
Dnd Marketing Dept.

Lorenzo De Bon
Marco Tonet
- Webkolm -

dnd

Dnd Martinelli S.r.l.

Via Piani di Mura, 2
25070 Casto (BS) - Italia

T +39 0365 899113
info@dndhandles.it

www.dndhandles.it



© 2024 Dnd Martinelli S.r.l.

Tutti i diritti riservati
All rights reserved