

STAINLESS STEEL

ELECTROHYDRAULICS

MASTER CATALOG

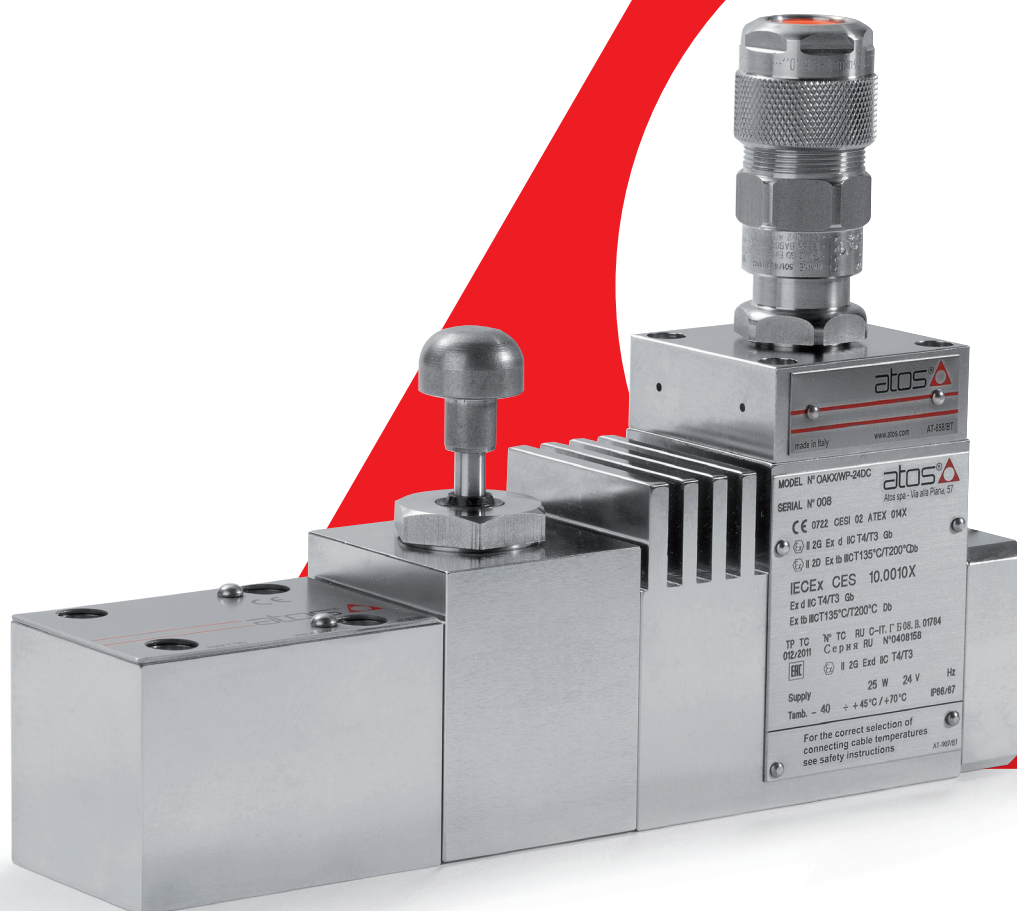



● **First class facilities**

high level of automation
with in-line process control

● **Know-how**

from the design to the production
of the finished product

● **Full product range**

standard, customized, ex-proof,
stainless steel, safety certified

● **Advanced technology**

thanks to long lasting
investments in R&D

● **Quality first**

according to ISO 9001, including
automotive's sector methods

● **Sales & service**

worldwide network of experienced
engineers, oriented to customer care

● **Professional team**

to quickly meet every
customer need



INDEX

STAINLESS STEEL

		Size	Qmax [l/min]	Table	Pag
TECHNICAL INFORMATION					
Basics for electrohydraulics in corrosive environments				W010	5
Summary of Atos stainless steel components				W020	11
Basics for electrohydraulics in hazardous environments				X010	19
ON-OFF VALVES					
Ex-d directional valves, solenoid operated					
DHAX, DHAXS	direct, spool type, subplate, AC or DC solenoids	06	70	EW010	29
DLAHX, DLAHXS	leak-free, direct, poppet type,	06	12	EW020	37
DLHAMX, DLAHMXS	subplate, AC or DC solenoids		30		
DLAHPX, DLAHPXS	leak-free, piloted, poppet type,	06	40	EW050	45
DLAPX, DLAPXS	subplate, AC or DC solenoids	16	220		
directional valves, hydraulic operated					
DLHPX, DLHPXS	leak-free, poppet type, subplate	06	40	EW100	51
DLPX, DLPXS		16	220		
pressure valves					
CART MX, CART MXS	relief, direct, screw-in cartridge	G1/2" ÷ M33	2,5 ÷ 40	CW010	55
CART AREX, CART AREXS		M35	120		
HMPX, HMPXS	relief, direct, modular	06	35	DW010	59
pressure safety valves, PED 2014/68/EU					
CART MX/PED, CART MXS/PED	relief, direct, screw-in cartridge	G1/2" ÷ M33	2,5 ÷ 60	CWY010	63
CART AREX/PED, CART AREXS/PED		M35	150		
ISO cartridges					
SC LIX, LIMMX, LIMMXS	pressure relief, 2 way, functional cover, piloted	25	370	HW010	67
accessories					
CABLE GLANDS	for ex-proof proportional and on-off valves, standard or armoured cables			KX800	71
CYLINDERS					
ISO 6020-1		∅ bores [mm]	Pmax [bar]		
CNX	round heads with counterflanges	50 ÷ 100	150	BW500	75
OPERATING INFORMATION					
Operating and maintenance information for stainless steel on-off valves				EW900	77
Operating and maintenance information for stainless steel PED pressure relief valves				CWY900	87
Operating and maintenance information for stainless steel cylinders & servocylinders				BW900	91

Supplementary components range available on www.atos.com

Basics for electrohydraulics in corrosive environments

aggressive & explosive atmospheres, water-based fluids

The term "corrosive environments" for fluid power systems refers to environmental conditions in which following situations can separately or contemporary exist. They represent a potential cause of heavy corrosion for all components installed in the system.

- The surrounding atmosphere is so aggressive as to chemically attack the metal surfaces
- The operating fluid contains a high percentage of water to cause oxidation of the metal components in contact with the fluid itself

Corrosion is a natural process that converts metals into a chemically-stable forms such as oxide, hydroxide, or sulfide. It is the irreversible and progressive destruction of materials by chemical and/or electrochemical reaction with their environment. It is the enemy of any metallic structure and component, being the very common cause of failure.

ATOS has developed a complete line of stainless steel components specifically designed to withstand aggressive atmospheres, ensuring performance and reliability of systems operating with water-based fluids like those of oil-based hydraulics.

X FULL STAINLESS STEEL with all parts made in stainless steel for complete protection to aggressive atmospheres and water-based fluids

XS EXTERNAL STAINLESS STEEL execution with only external parts made in stainless steel to provide the best surface protection to aggressive atmosphere in systems operated with standard mineral oils

XW INTERNAL STAINLESS STEEL execution with only internal parts made in stainless steel, specific for systems operated with water-based fluids

1 AGGRESSIVE ATMOSPHERES

Hydraulic systems are often located in outdoor areas, exposed to rain and atmospheric agents, or in coastal and marine environments. Such critical installations can lead to severe corrosion of the external surfaces, with the consequent risk of breakdowns or in extreme cases structural collapses, which entail higher maintenance costs.

Coastal and marine environments are the worst corrosive conditions for metals because of the quantity of sodium chloride (salt) present in the water and then in the air. The marine atmosphere also includes installations where splashing and heavy sea spray are encountered. The equipment exposed to these splash zones are indeed subjected to the worst conditions of intermittent immersion with wet and dry cycling of the corrosive agent.

However, the above environments are not the only ones prone to accelerated corrosion.

In highly industrial environments, contaminants in the air can contribute to corrosion. Emissions that come from factories, or power plants can potentially weaken the equipment. Gases like sulfur and nitrogen oxide that are emitted into the atmosphere in industrial locations, return in forms of condensation, such as acidic dew or acid rain.

Industrial dust particles can be contaminated with harmful metal oxides, chlorides, sulfates, sulfuric acid, carbon, and carbon compounds. These particles when combined with oxygen, water, or high humidity environments can be highly corrosive.

In applications with aggressive atmospheres, the use of Atos stainless steel valves **X** or **XS** is recommended

1.1 Aggressive & explosive atmospheres

In critical applications the aggressive and even potentially explosive atmospheres can coexist. For example in offshore drilling platforms and oil tankers, the saline environment is combined with the presence of highly flammable gases and vapors. For these reasons Atos solenoid operated stainless steel valves are equipped with ex-proof solenoids manufactured according to protection mode **ex-d** and certified to major international standards.

Following table summaries the main industrial sectors with relevant potential corrosive environments

	Sector	Potential cause of corrosion	Suggested Atos stainless steel execution
	Underground mines	Water-based fluids Explosive atmosphere may be present	X
	Oil refineries Power plants	Acid atmospheres Explosive atmosphere may be present	XS
	Steel industry, Die casting Light alloy casting	Water-based fluids, Pure water	X XW (1)
	Offshore & Marine	Salty atmospheres, Heavy sea water spray Explosive atmosphere may be present	XS
	Chemical industry	Acid atmospheres, Corrosive fluids Explosive atmosphere may be present	X
	Pharmaceutical industry Food processing	Pure water	X XW (1)

(1) XW can be used with water-based fluids or pure water, but only in absence of aggressive atmosphere.

1.2 Low temperature



Several hydraulic systems operate in northern areas or arctic regions with particularly cold environments. Even if the corrosion rate will be lower in a cold climate than in a temperate one, low temperatures are critical because they induce fragility in the materials and deterioration of the seals.
Atos stainless steel components **X** and **XS** are designed to operate in cold environments up to **-40°C**



For extreme conditions, option **BBT** for full stainless steel components type **X**, is available for ambient temperature up to **-60°C**

2 WATER-BASED FLUIDS

The use of water-based hydraulic fluids derives from two main requirements:

- To guarantee the safety against the risk of fire
- To reduce the degree of environment contamination in the event of accidental leaks



Safety against fire risk: hydraulic systems operate at high pressure levels, in case of accidental pipe breakages, the hydraulic fluid may ignite if coming in contact with hot surfaces.
In order to prevent risk of fire, industrial sectors like steel industry and light alloy casting, often use fire-resistant fluids instead of mineral oils.

Several types of fire-resistant fluids are existing in the market: synthetic types involve toxicological risk with consequent handling problems. For this reason, hydraulic water-based fluids are often preferred due to easy handling, the not toxic characteristics, and lower costs.

These fluids are available in different types depending on the water percentage which can reach up to 98% and they are largely used due to their fire-retardant properties.

Water-based hydraulic systems traditionally have been used in mining applications, in hot-metal areas of steel mill, die casting machines and light alloy foundries.



Eco-compatibility: the environmental impact has strongly influenced the solutions adopted in industrial plants and mobile machinery. Considering the costs associated with preventing and cleaning up environmental contamination, water-based hydraulic systems hold the potential for consistent cost savings.

Since water represents the main component in these fluids (90% or more), the hydraulic systems must be able to operate at low viscosity and must guarantee protection against oxidation by use of selected materials. In fact, despite corrosion protection additives are present in these fluids, materials made of steel, copper, zinc, aluminum, bronze, and brass alloys, as well as combinations of these materials have a higher corrosion tendency in presence of water.



Pure water: applications with severe eco-compatible requirements or production processes where the products must not be contaminated by any trace of oil or other substances, strongly require the use of pure water.

In applications with water-based fluids or pure water, the use of Atos stainless steel valves type **X** or **XW** is recommended

The following table summarizes the classification of water-based fluids and their characteristics

Water-based fluids			
Classification to ISO12922	Fluid characteristics and main applications	Corrosiveness	Environmental impact
HFA-E	Oil in water emulsion. Water content > 80% Underground mines, steel plants	High	Low
HFA-S	Synthetic aqueous solution. Water content = 90%-98% Underground mines, steel plants, foundries, metalforming processes	High	Low
HFB	Water in oil emulsion. Water content = 40%-60% Mobile machines As a result of a high mineral oil content up to 60%, for some applications they do not meet the limit values for fire resistant characteristics	Low	High
HFC	Water glycol solution. Water content = 35%-55% Applications: steel plants, die casting as well as other industries, representing approximately 50% of the total fire-resistant hydraulic fluids market.	Low	High
Pure water	100% de-mineralized water Food processing, pharmaceutical industry, any application with severe eco-compatibility requirements	Very high	None

3 ANTI-CORROSION MEASURES

There are several methods to protect the components from corrosion. Among these we can mention **protective** methods and **preventive** methods.

They represent two different approaches, normally selected depending on working conditions of the components and the level of aggressiveness of the environment in which they will operate.

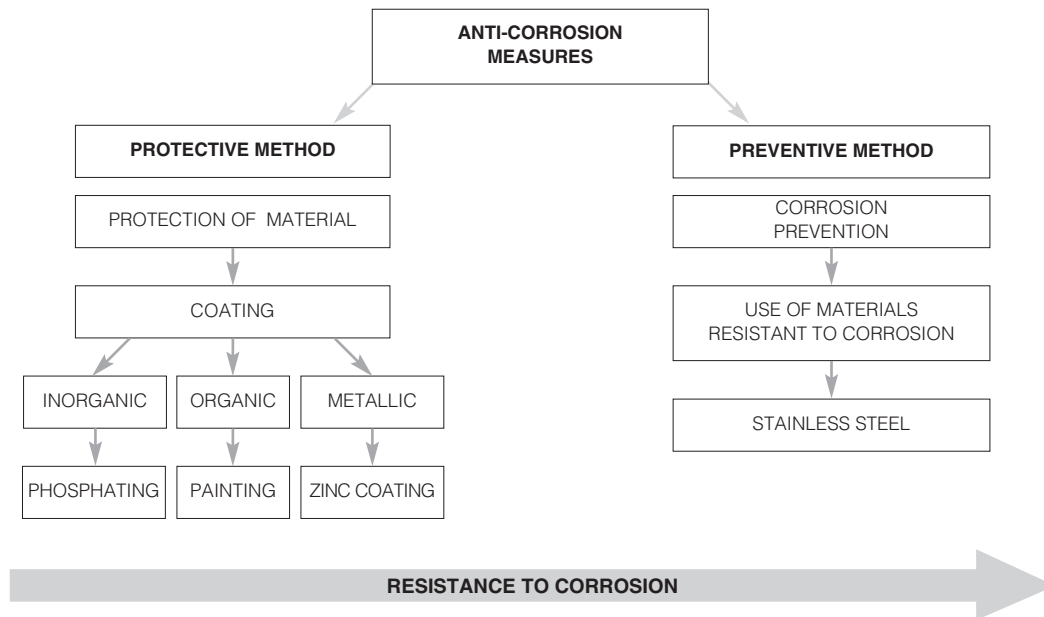

3.1 Protective methods

They are based on protective coatings applied on the surface of steel materials. They offer a good surface protection to aggressive atmospheres but no protection of internal parts in case of water-based fluids. The protection is affected by potential scratches on the surface.

In the following we evidence the most common protective methods:

- **PHOSPHATIZING** offers a medium resistance to corrosive environments; it is not indicated for strong aggressive environments like salty atmospheres. It is a good basic treatment for subsequent painting.
- **PAINTING** is a widely adopted method to protect the surfaces from corrosion. For strong aggressive environments like marine, inorganic zinc paint and specific painting processes as per ISO 12944 are used.
- **GALVANIC ZINC COATING** is one of the best protection methods for steel materials.

Atos has developed for its standard products range an exclusive treatment process named **ECP** that guarantees an excellent surface protection to aggressive environments, see section 5



ECP is a global surface protection combining different type of treatments for the several parts of hydraulic components:

- Parts made in carbon steel or cast iron: zinc coating with black passivation
- Caps and protections made in aluminum: black opaque anodizing
- On-board drivers housing: anodizing
- Aluminum name plates: natural gloss light grey anodizing
- DC coils, external metallic parts: zinc coating (gloss silver)
- Screws: GEOMET 500A treatment
- Other parts such as DIN plugs and nuts: galvanizing + passivation

3.2 Preventive methods

They consist in the use of materials with intrinsic resistance to corrosion. Among these, stainless steel meets the mechanical properties typical of carbon steels, with intrinsic characteristics of noble materials such as the resistance to corrosive phenomena.

Stainless steel materials offer a higher protection to corrosion with respect to protective coating methods.

The protection is ensured both for external and internal surfaces, then this is the ideal solution in case of water-based fluids. Moreover, the corrosion protection is not affected by accidental scratches of the component surface.

4 STAINLESS STEEL MATERIALS

There are several types of stainless steel materials having different mechanical, physical and corrosion resistance characteristics. The most common designation methods in the stainless steel sector is the AISI (American Iron and Steel Institute).

In the following table are reported the stainless steel classification and the specific types used in Atos stainless steel valves

Classification	AISI Series	Characteristics and main applications	Materials used in Atos stainless steel valves
Austenitic	200 300	Best corrosion resistance of all stainless steels because they contain at least 16% chromium. Added nickel and manganese hold the metal in an austenitic microstructure. AISI 316L offers the best resistance to salt and acids AISI 302 steel has excellent mechanical properties and good corrosion resistance.	AISI 316L - Valve Body ① Cylinders housing and heads ① AISI 316 A4 - Cylinders tie rods ② AISI 302 - Spring ②
Ferritic	400	Ferritic stainless steels contain only chromium in the range of 11% to 30% but they have a lower carbon content than the martensitic ones. AISI430F has moderate resistance to corrosion, which increases with the percentage of chromium. It is ideal for parts to be machined in high speed machine tools. AISI 431 steel is particularly suitable for induction hardening. Among the martensitic steels it reaches the highest corrosion resistance values	AISI 430F - Solenoid tube ③ AISI 431 - Cylinders rod and piston ③
Martensitic	400 500	They contain 12 to 14% chromium, 0.2 to 1% molybdenum, and no significant amount of nickel. It is considered strong and hardenable by heat treatment. AISI420B provides the maximum corrosion resistance in the hardened state and after polishing. AISI440C high hardness steel has good corrosion resistance and excellent wear resistance.	AISI 420B - Washer ④ AISI 440C - Valve spools ⑤
Precipitation Hardening	17-4PH	PH stainless steels contain around 17% chromium and 4% nickel. AISI 630 steel has excellent resistance to corrosion. Similarly to martensitic stainless steels. The 17-4 PH reaches the optimal resistance to corrosion after heat treatment.	AISI 630 - Solenoid housing ⑥

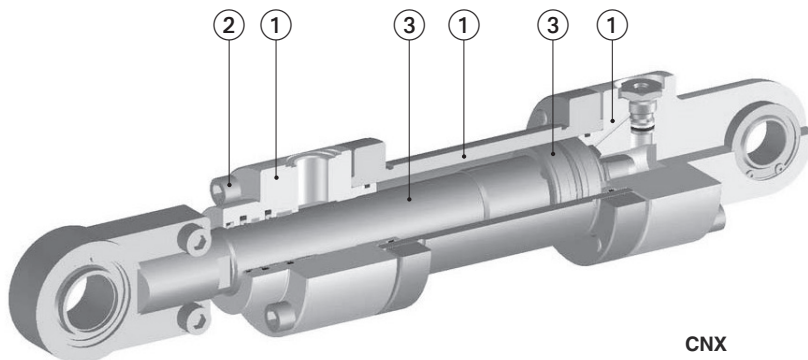
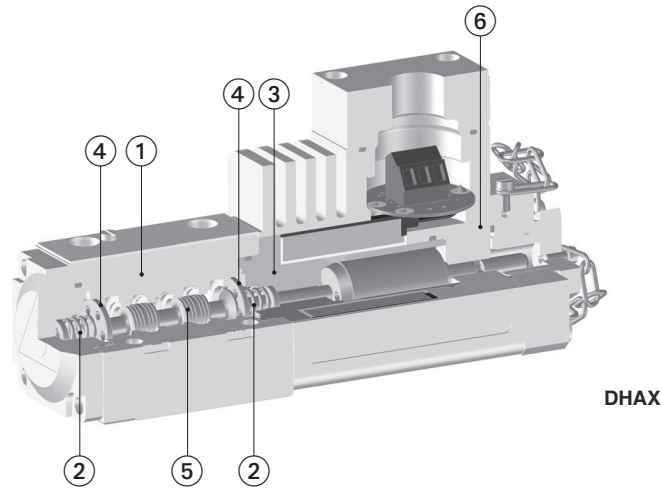

5 SPECIFICATIONS TO VERIFY THE CORROSION RESISTANCE

ISO 9227 - the method recognized at European regulatory level, is the accelerated corrosion tests in a salt spray chamber according to UNI EN ISO 9227:2006 Corrosion tests in artificial atmospheres - Salt spray tests

This standard defines the requirements of the equipment and the procedure that must be used to perform the tests in neutral salt spray (NSS), salt-acetic fog (AASS) and cupro acetic salt spray (CASS), to evaluate the resistance to corrosion of metallic materials, with or without permanent or temporary anticorrosive protection.

The salt spray test it is not directly representative of the corrosion protection in real atmospheres, due to the high concentration of chloride and the absence of dry periods. However, this is a practical test, mainly used for the qualification of protection processes. It is a comparative method useful to verify the corrosion resistance of a certain material in comparison with others.

All Atos components are approved with salt spray tests in order to guarantee the best resistance to environmental corrosion

600h
SALT SPRAY

+1000h
SALT SPRAY

5.1 Resistance in salt neutral spray test (NSS)

Carbon steel with zinc surface treatment

The resistance to corrosion is expressed in hours of performance in neutral salt spray (NSS according to UNI ISO 9227), before white and red oxidization appears on 5% of the total surface of the sample under test.

The white oxidization is the first step of corrosion. It evidences that the protective effect of the zinc passivation is ended, and the salt is going to attack the zinc layer. In this situation the steel material remains integer because it is still protected by the zinc layer.

Once the zinc layer is finished, the corrosion attacks the steel material and then there will be the appearance of red oxidization (red rust), which is the second type of corrosion that must be verified in the salt spray test.

The salt spray resistance of the main Atos components is shown in the following table.

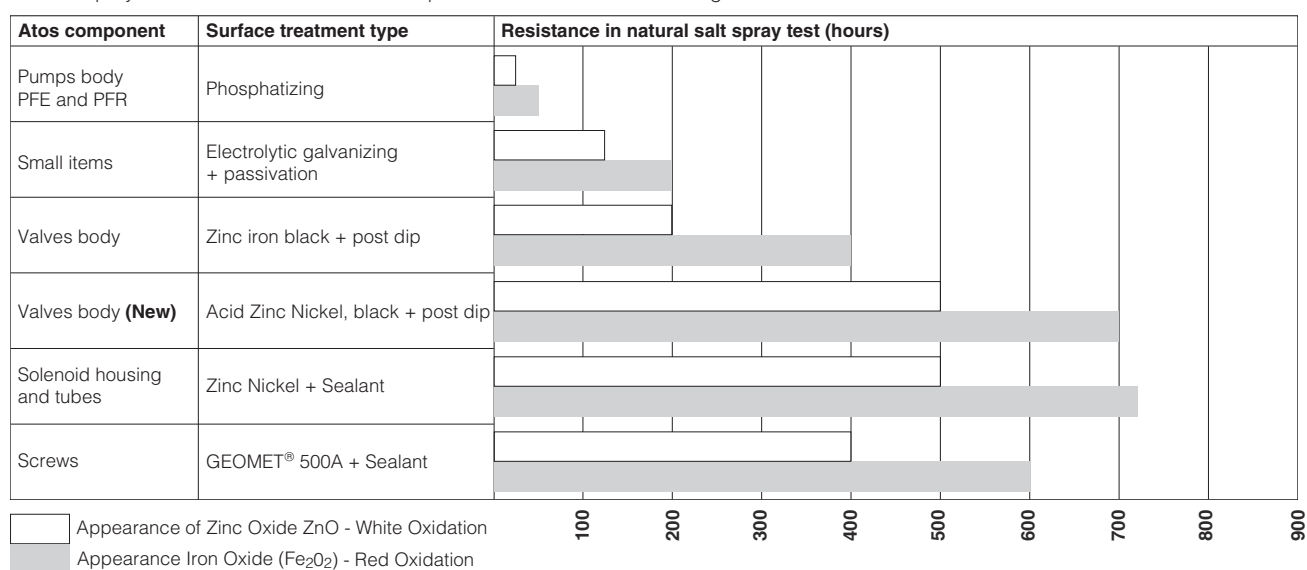

Stainless steel - resistance in salt neutral spray test (NSS)

Stainless steels materials offer a corrosion resistance characteristic typically higher than carbon steels with surface treatments.

The corrosion resistance of stainless steels depend to their type and class and to the aggressive environment to which they are exposed. Corrosion phenomena in many cases are limited to surface oxidation phenomena due to "free iron" and they manly concern to aesthetic factors rather than effective corrosion.

However, in some circumstances, they may present local corrosion attack such as the alveolar corrosion which is the predominant form of stainless steel corrosion.

The salt spray resistance of the main Atos stainless steel components is shown in the following table.

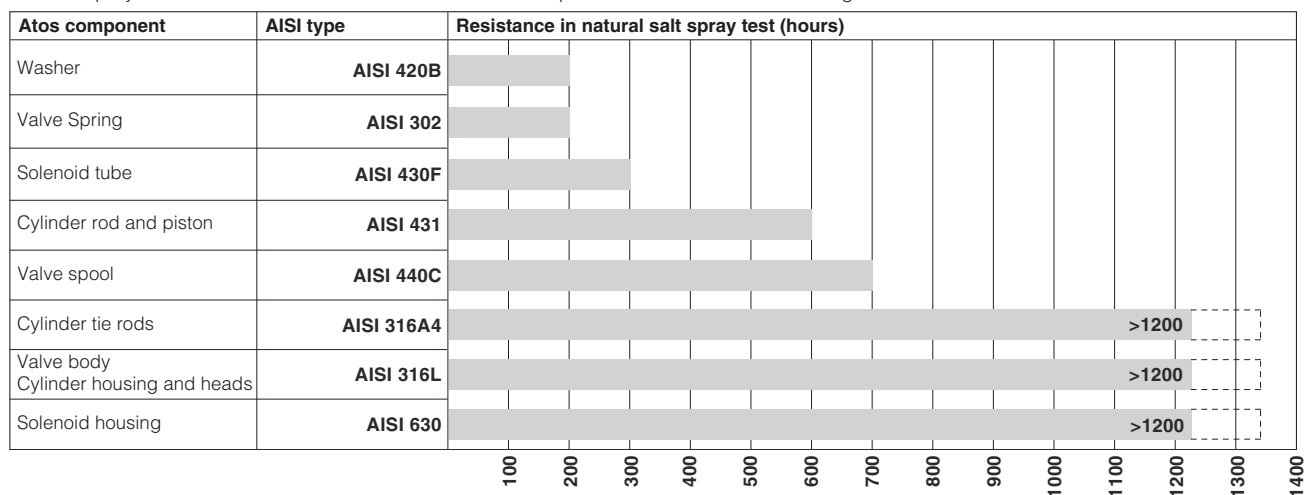

ISO 9223 - this standard establishes a classification system for the corrosiveness of atmospheric environments.

It defines the corrosivity classes of atmospheric environments, based on the corrosion rate detected on standardized metallic samples in one year of exposure.

The corrosion rates are classified in 6 different categories C1, C2, C3, C4, C5, CX calculated on the annual corrosion loss of metals like zinc, copper and carbon steel [$\mu\text{m}/\text{year}$] and it makes possible a rough identification of the corrosivity class based on the knowledge of the local environment.

The standard specifies the key factors in atmospheric corrosion of metals and alloys. These are made up of the combined effect of temperature and humidity and sulfur dioxide pollution and salinity carried by the air.

Classification based on measurement of corrosion rate for Zinc - data are provided for the first year of exposure to the specific environment

Corrosion Category ISO9223	Corrosiveness	Corrosion rate for Zinc layer ($\mu\text{m}/\text{year}$)	Duration of protection (1)	Salt spray test ISO9227	Typical outdoor environment
C1	Very low	<0,1	-	-	Dry or cold zone, atmospheric environment with low pollution
C2	Low	0,1÷0,7	-	-	Temperate zone, atmospheric environment with low pollution ($\text{SO}_2 < 12 \mu\text{g}/\text{m}^3$) Dry or cold zone, atmospheric environment with short time of wetness, e.g. deserts, sub-arctic areas.
C3	Medium	0,7÷2,1	Short Medium Long	120 h 240 h 480 h	Temperate zone, atmospheric environment with medium pollution ($\text{SO}_2: 12\div40 \mu\text{g}/\text{m}^3$) or certain effect of chlorides, coastal areas with low deposit of chlorides
C4	High	2,1÷4,2	Short Medium Long	240 h 480 h 720 h	Temperate zone, atmospheric environment with high pollution ($\text{SO}_2: 40\div80 \mu\text{g}/\text{m}^3$) or substantial effect of chlorides, e.g. polluted urban areas, industrial areas, coastal areas without spray of salt water. Tropical zone, atmosphere with medium pollution
C5	Very high	4,2÷8,4	Short Medium Long	480 h 720 h 1440 h	Temperate zone, atmospheric environment with very high pollution ($\text{SO}_2: 80\div250 \mu\text{g}/\text{m}^3$) and/or strong effect of chlorides, e.g. industrial areas, coastal and offshore areas with salt spray. Tropical zone, atmosphere with high pollution and/or strong effect of chlorides
CX	Extremely high	>8,4	-	-	Subtropical and tropical zone, very humid period, atmospheric environment with very intense pollution (SO_2 above $250 \mu\text{g}/\text{m}^3$) Strong effect of chlorides i.e. coastal and offshore areas, occasional contact with salt spray.

- (1) Short = 2-5 years
Medium = 5-15 years
Long = >15 years

Summary of Atos stainless steel components

Atos stainless steel components are electro-hydraulic equipment for industrial and mobile applications, designed to operate in corrosive and potentially explosive environments, such as oil & gas, marine, offshore, etc. and with special fluids HFA-E, HFA-S, HFB, HFC having a high percentage of water or 100% pure water.

1 PRODUCTS RANGE

Atos stainless steel range includes a consistent line of hydraulic valves and actuators among the largest ones used in applications that require high corrosion resistance: directional valves, pressure relief valves, cylinders and servocylinders.

Up to three stainless-steel executions are available to satisfy the most demanding applications:

X FULL STAINLESS STEEL execution with all parts made in stainless steel offers the complete protection for external and internal surfaces. It is the ideal choice for applications combining aggressive atmospheres and water-based fluids.

XS EXTERNAL STAINLESS STEEL execution with only external parts made in stainless steel. It is specifically designed to provide the best surface protection to aggressive atmosphere, while the operating fluid is standard mineral oil, HLP type or similar. All internal parts in contact with the fluid are made in carbon steel to reduce the costs respect to the full stainless steel execution.

XW INTERNAL STAINLESS STEEL execution with only internal parts made in stainless steel, specific for systems operated with water-based fluids but not subjected to aggressive atmosphere. These components are available on request. Technical tables are not present in KTW catalog, but in supplementary components range available on www.atos.com

Valves type **X**, **XS** and **XW** are standard equipped with NBR low temperature seals suitable for temperature range -40 to +70°C

Valves type **X** with option **BBT** are equipped with FMVQ fluorosilicon seals suitable for temperature range -60°C to +70°C

1.1 ON-OFF DIRECTIONAL VALVES

Stainless steel directional valves range includes 4-way spool type valves or 3-way popper type leak free.

Solenoid operated valves are equipped with ex-proof solenoids designed to operate in hazardous environments with presence of flammable liquids, gases, vapors or combustible dust, and certified to major international standards, see section [3]

XW execution is available with Ex-proof or standard solenoids

Component	Execution	Solenoid	SIL (1)	Ex-proof certification						Tech. table	
				Environment	Multicertification				North American		Marking
					ATEX	IECEX	EAC	PESO	cULus		
4-way, spool type, direct, solenoid operated	X, XS, XW	Ex-d	●	Gas	●	●	●	●	●	See section 5.1 and 5.2	EW010
				Dust	●	●	●	-	-		
	XW	standard	-	-	-	-	-	-	-	-	TE135
3-way, poppet type, direct, solenoid operated	X, XS, XW	Ex-d	●	Gas	●	●	●	●	●	See section 5.1 and 5.2	EW020
				Dust	●	●	●	-	-		
	XW	standard	-	-	-	-	-	-	-	-	TE135
3-way, poppet type, piloted, solenoid operated	X, XS, XW	Ex-d	-	Gas	●	●	●	●	●	See section 5.1 and 5.2	EW050
				Dust	●	●	●	-	-		
	XW	standard	-	-	-	-	-	-	-	-	TE135
3-way, poppet type, piloted, hydraulic operated	X, XS, XW	-	●	-	-	-	-	-	-	-	EW100

(1) Valves are SIL compliance with IEC 61508 (TÜV certified). They meet the requirements of SC3 (systematic capability) up to SIL 3

1.2 ON-OFF PRESSURE RELIEF VALVES

Stainless steel pressure relief valves range includes screw-in, ISO cartridge and modular executions.

Screw-in type are also available in Safety execution conforming to PED Directive 2014/68/EU.

Component	Execution	PED Directive	Marking	Tech. table
Screw-in cartridges	X, XS			CW010
	X, XS	●	See section [6]	CWY010
Modular	X, XS			DW010
ISO functional cover	X, XS			HW010
ISO cartridge	X			

1.3 HYDRAULIC CYLINDERS & SERVOCYLINDERS

Stainless steel, round heads cylinders and servocylinders with tie-rods.

Servocylinders are equipped with low friction seals and position transducer, magnetosonic or inductive type

Component	Execution	Description	Tech. table
Cylinders	X	round heads	BW500
Servocylinders	X	with built-in magnetosonic transducer	
		with built-in inductive transducer	
		with built-in potentiometric transducer	

2 STAINLESS STEEL MATERIALS SPECIFICATIONS

Atos stainless steel valves are made by selected stainless steel materials coupling the best corrosion resistance to excellent mechanical characteristics. In the following are listed the AISI classification of stainless steel materials used for the main parts of X, XS and XW valves.

2.1 On-off directional valves

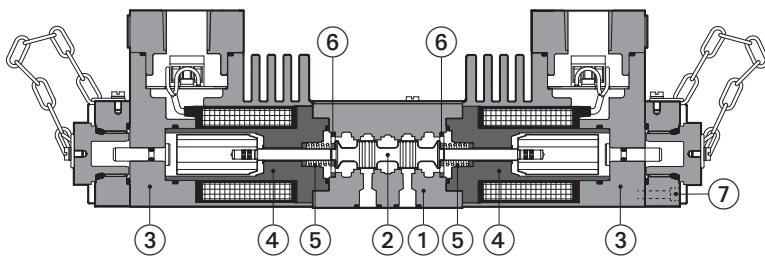

direct, Ex-proof solenoid, X, XS, XW executions
(see Table I)

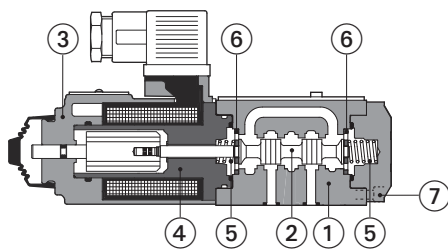

direct, standard solenoid, XW execution
(see Table I)

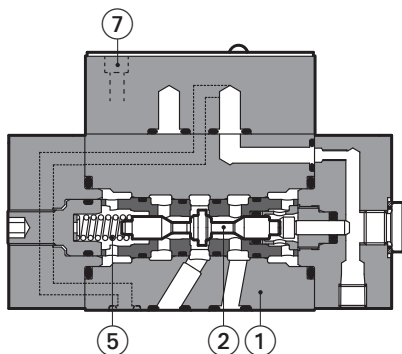

piloted, X, XS executions
(see Table I)

Table I

Item	Component part	Execution		
		X	XS	XW
1	Body and caps	AISI 316L	AISI 316L	AISI 316L
2	Spool, Poppet	AISI 440C	Carbon steel	AISI 440C
3	Solenoid housing	AISI 630	AISI 630	Carbon steel
4	Solenoid tube	AISI 430F	Carbon steel	AISI 430F
5	Springs	AISI 302	AISI 302	AISI 302
6	Washers	AISI 420B	Carbon steel	AISI 420B
7	Screw	AISI 316	AISI 316	Carbon steel

2.2 On-off pressure relief valves

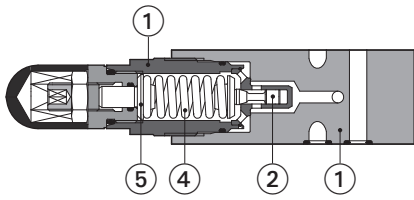

direct, modular, X, XS executions
(see Table II)

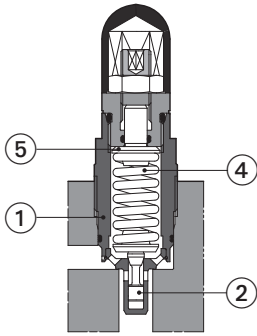

direct, screw-in cartridge,
X, XS executions
(see Table II)

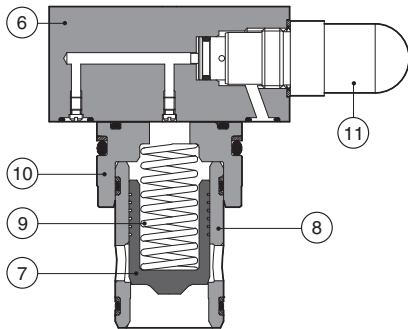

piloted, ISO cartridge X, XS executions
(see Table III)

Table II

Item	Component part	Execution	
		X	XS
1	Body	AISI 316L	AISI 316L
2	Poppet	AISI 440C	Carbon steel
3	Sleeve	AISI 420B	Carbon steel
4	Spring	AISI 302	AISI 302
5	Washer	AISI 420B	AISI 420B

Table III

Item	Component part	Execution	
		X	XS
6	Body	AISI 316L	AISI 316L
7	Poppet	AISI 440C	AISI 440C
8	Sleeve	AISI 420B	AISI 420B
9	Spring	AISI 302	AISI 302
10	Cap	AISI 630	AISI 630
11	Pilot	see above table II	

2.3 Hydraulic cylinders & servocylinders

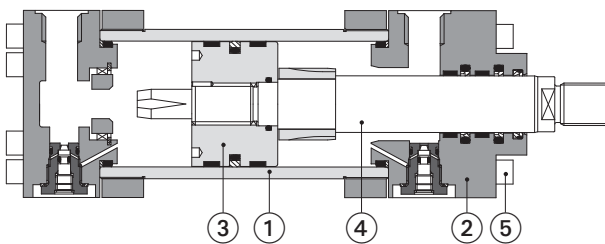

round heads cylinder X execution
(see Table IV)

Table IV

Item	Component part	Execution	
		X	
1	Housing	AISI 316L	AISI 630 17-4 PH (1)
		AISI 316L	AISI 630 17-4 PH (1)
2	Heads	AISI 316L	AISI 630 17-4 PH (1)
3	Piston	AISI 431	AISI 630 17-4 PH (1)
4	Rod	AISI 431	AISI 630 17-4 PH (1)
		AISI 316 A4	AISI 630 17-4 PH (1)
5	Tie rods	AISI 316 A4	AISI 630 17-4 PH (1)

(1) Available on request for heavy duty applications

3 CERTIFIED EXECUTIONS FOR EXPLOSIVE ATMOSPHERES

Atos stainless steel ex-proof valves are equipped with ex-proof solenoids engineered and manufactured according to protection method **Ex-d** (code **Ex-t** for dust environments) and certified by independent notified bodies in conformity to following standards:

3.1 Multicertification: ATEX, IECEx, EAC, PESO standards

It is a great plus offered by Atos ex-proof stainless steel valves, where the same component is provided with the following certifications:



ATEX Directive 2014/34/EU, applicable within the European Union



IECEx International Electrotechnical Commission Explosive, required to access international markets



EAC Eurasian Certification

It is applicable to the Customs Union Territory Including Russia, Kazakhstan, Belarus, Armenia and Kyrgyzstan



PESO Petroleum and Explosive Safety Organization (earlier known as CCoE)

It approves products distributed within Indian territory

3.2 cULus North America standards



This type of UL logo indicates compliance with both Canadian and U.S. requirements.

Atos ex-proof components are marked with cULus Listed logo stating that they have been investigated by UL Underwriters laboratory in accordance with following standards:

- UL 1203** Standard for Explosion-Proof and Dust-Ignition-Proof Electrical Equipment for use in Hazardous (classified) locations
- UL 429** Standard for Electrically Operated valves
- CSA C22.2 No. 139-13** Electrically Operated Valves

4 FLAMEPROOF ENCLOSURE Ex-d

Technical characteristics

It is characterized by a strong mechanical construction, capable of withstanding the overpressure caused by a potential internal explosion and preventing the spread of flames to the external environment. It permits to dissipate the heat generated by the solenoid, in order to limit the surface temperature within certified classes (T6, T5, etc), to avoid the self-ignition of the surrounding flammable atmosphere.

Internal parts are sealed inside a ruggedized flameproof enclosure, granting high protection to the risk of explosion.

The rugged design of the flameproof enclosure made in AISI 630 (17-4 PH), combined with IP66/67 ingress protection, makes the stainless steel ex-proof valves suited for application in highly corrosive and harsh environments.

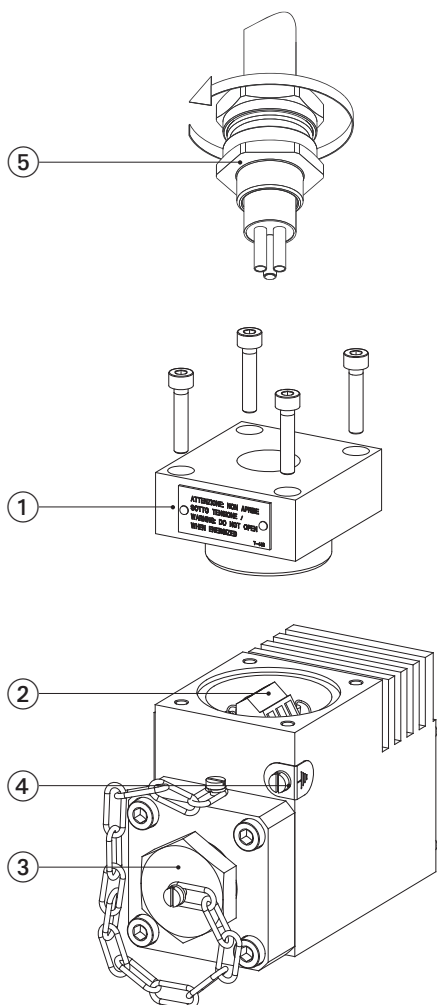

Electrical wiring of ex-proof Multicertified solenoids

The electrical wiring to the terminal board of ex-proof solenoids, must be performed using stainless steel ex-proof certified cable glands, see tech. table KX800.

Electric cables must be approved for the specific temperature class reported on the ex-proof component's nameplate, refer to specific tech. table of ex-proof valves for cable temperature.

Electrical wiring of ex-proof solenoids certified cULus

The electrical wiring to the terminal board of ex-proof solenoids must be performed using **UL** certified cable glands, or conduit pipe.

Electric cables must be **UL** approved for the specific temperature class reported on the ex-proof component's nameplate, refer to specific tech. table of ex-proof valves for cable temperature.

- ① cover with threaded connection for cable gland fitting
- ② terminal board for cables wiring
- ③ standard manual override protected by cap
- ④ screw terminal for additional equipotential grounding (only Multicertified solenoids)
- ⑤ cable glands (only Multicertified solenoids)

5 NAMEPLATE MARKING FOR EX-PROOF SOLENOIDS

Stainless steel ex-proof valves are provided with a specific nameplate reporting the certificate number, the notified body and the classification according to the relevant certification.

The classification identifies the protection method and the compatibility of the ex-proof component for a specific hazardous environment. The following sections provide a detailed description of the nameplate marking for component categories.

5.1 Ex-proof solenoid multicertified to ATEX, IECEX, EAC and PESO



Gas - group II 2G - Zone 1, 2
Dust - group II 2D - Zone 21, 22

- ① ATEX notified body and certificate number
- ② Marking according to ATEX Directive
- ③ IECEX notified body and certificate number
- ④ Marking according to IECEX Scheme
- ⑤ EAC notified body and certificate number
- ⑥ Marking according to EAC
- ⑦ PESO certificate number
- ⑧ Power supply characteristics
- ⑨ Ambient temperature
- ⑩ Ingress protection:
 -IP66 = no dust ingress, protection against heaving seas or powerful jets of water
 -IP67 = no dust ingress, protection to water immersion
- ⑪ Solenoid model code
- ⑫ Solenoid serial number

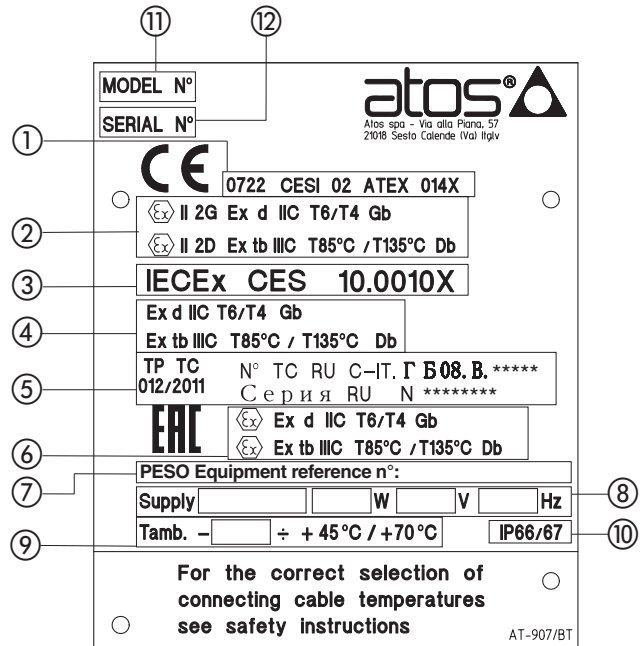

ATEX / IECEX / EAC / PESO classification - for Gas group II

II 2 G	Ex	d	IIC	T6 / T4	Gb
Equipment Group II industrial Equipment Category 2 High Protection Suitable for use G Gas	Mark of Explosion Proof	Protection Method d Flameproof enclosure	Gas Group IIC Hydrogen & Acetylene	Temperature Class T6 ≤ 85°C T4 ≤ 135°C	Equipment Protection Level Gb High protection (Gas, Zone1)

ATEX / IECEX / EAC classification - for Dust

II 2 D	Ex	tb	IIIC	T85 / T135	Db
Equipment Group II industrial Equipment Category 2 High Protection Suitable for use D Dust	Mark of Explosion Proof	Protection Method tb Protection by enclosure	Dust Group IIIC Conductive Dust	Temperature Class T85 ≤ 85°C T135 ≤ 135°C	Equipment Protection Level Db High protection (Dust, Zone21)

RELATED DOCUMENTATION

EW010	DHAX, DHAXS - on-off, direct, spool type
EW020	DLAHX, DLAHXS, DLAHMX, DLAHMXS - on-off, direct, spool or poppet type
EW050	DLAHPX, DLAHPXS, DLAPX, DLAPXS - on-off, piloted, poppet type leak free

Class I, Division I, Groups C & D
Class I, Zone 1, Groups IIA & IIB

- ① cULus marking and certificate number
- ② Marking according to NEC 500 and NEC 505 standards
- ③ Ambient temperature
- ④ Power supply characteristics
- ⑤ Solenoid model code
- ⑥ Solenoid serial number

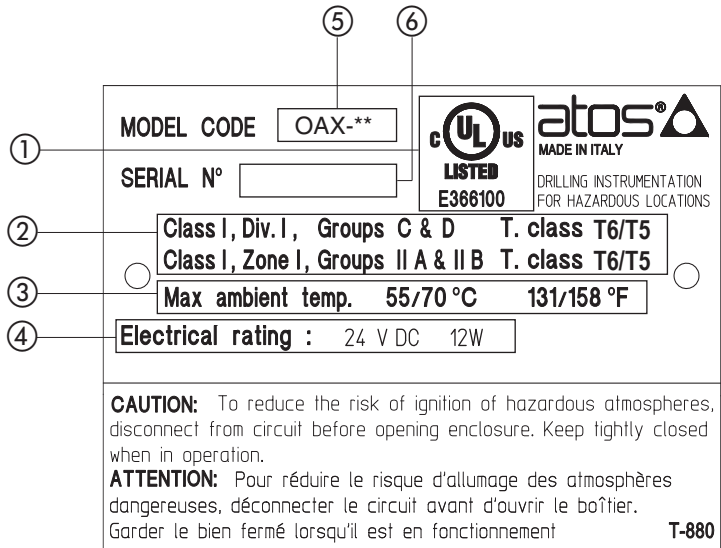

MODEL CODE OAX-**

SERIAL N° []

Class I, Div. I, Groups C & D T. class T6/T5
Class I, Zone 1, Groups IIA & IIB T. class T6/T5

Max ambient temp. 55/70 °C 131/158 °F

Electrical rating : 24 V DC 12W

CAUTION: To reduce the risk of ignition of hazardous atmospheres, disconnect from circuit before opening enclosure. Keep tightly closed when in operation.
ATTENTION: Pour réduire le risque d'allumage des atmosphères dangereuses, déconnecter le circuit avant d'ouvrir le boîtier.
 Garder le bien fermé lorsqu'il est en fonctionnement

T-880

NEC 500 classification

Class I	Division I	Groups C & D	T6/T5
Class I Equipment for flammable Gas and Vapors	Division I Explosive substances continuously or intermittently present in the atmosphere	Gas Group C Methane, Butane, Petrol, etc. D Ethylene, Formaldehyde, Chloropropane, etc.	Temperature Class T6 ≤ 85°C T5 ≤ 100°C

NEC 505 classification

Class I	Zone 1	Groups IIA & IIB	T6/T5
Class I Equipment for flammable Gas and Vapors	Zone 1 Location where explosive substance are continuously present	Gas Group IIA Methane, Butane, Petrol, etc. IIB Ethylene, Formaldehyde, Chloropropane, etc.	Temperature Class T6 ≤ 85°C T5 ≤ 100°C

RELATED DOCUMENTATION

- EW010** DHAX/UL, DHAXS/UL - on-off, direct, spool type
- EW020** DLAHX/UL, DLAHXS/UL, DLAHMX/UL, DLAHMXS/UL - on-off, direct, spool or poppet type
- EW050** DLAHPX/UL, DLAHPXS/UL, DLAPX/UL, DLAPXS/UL - on-off, piloted, poppet type leak free

6 NAMEPLATE MARKING FOR PED PRESSURE VALVES

The PED valves are factory set at the pressure level required by the customer.

The factory pressure setting Pset is marked on the valve nameplate, together with the burst pressure PS and the temperature range

- ① Valve code
- ② Factory pressure setting
- ③ Burst pressure
- ④ Min ÷ Max fluid or ambient temperature range
- ⑤ Valve serial number (1)
- ⑥ Notified body reference number
- ⑦ Hydraulic symbol

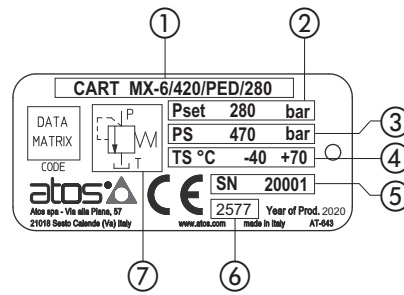

(1) Example for serial number:

20	-	001
Year: 20 = 2020		Progressive number

RELATED DOCUMENTATION

PED pressure relief cartridges

CWY010 CART MX*/PED, CART AREX*/PED - stainless steel safety pressure relief valves

Basics for electrohydraulics in hazardous environments

1 HAZARDOUS ENVIRONMENTS











“Hazardous Environments” are areas where flammable liquids, gases, vapors or combustible dust exist in sufficient quantities to produce explosions or fire.

Oil & gas, chemical, mining and power plants are highly-sensitive environments where the presence of a potentially explosive atmosphere can accidentally or permanently occur.

In these environments an accidental failure or a wrong operation could cause the ignition of the surrounding explosive atmosphere with fatal consequences for human and goods safety, therefore all electrohydraulic equipment operating in these areas must be suitable for hazardous environments and must be certified according to international standards.

The purpose of this document is to provide general information about worldwide certifications for hazardous environments and relevant classifications

Typical hazardous environments can be found in the following sectors:

Presence of Gas and Vapors		Presence of Combustible Dust	
	Oil & Gas Offshore drilling		Feed industry Grain handling and storage
	Oil refineries Power plants		Chemical & fertilizers Pharmaceutical
	Petroleum & LNG vessels		Wood & paper
	Aerospace industry		Metal processing
	Coal mines		Recycling operations

2 CERTIFICATIONS

Equipment with electrical parts designed for hazardous environments must be certified by third parties (notified bodies) in compliance with international standards for explosion protection.

There are several certifications concerning explosive environments and they are governed by local laws of the countries where they are applied.

In all certifications the basic principles for explosion protection are strictly regulated by severe international standards for explosion protection, as European norms EN60079 or North American NEC500 and 505.

These norms impose specific construction criteria and protection methods for the machinery and components to be used in potentially explosive areas.

WORLDWIDE CERTIFICATIONS

The following map shows the main certifications with the relative countries where they are most widely applied. International certification IECEx is recognized worldwide even in countries where local certifications exist.

ATOS CERTIFICATIONS
see section 3 for details

 ATEX Europe	 IECEx international
 EAC Russia	 UL LISTED North America
 PESO India	 MA China



 Canada	 Brazil	 Korea
---	---	--

3 CERTIFICATIONS FOR ATOS EX PROOF AND INTRINSICALLY SAFE COMPONENTS

Atos ex-proof and Intrinsically safe components are certified with major international certifications, as listed in the following.

Note: see technical table of each specific Atos component to verify the available certifications

MULTICERTIFICATION

Multicertifications is a great plus offered by Atos, where the same component is provided with the following certifications:



ATEX Directive 2014/34/EU, equipment and protective system intended for use in potentially explosive atmosphere

It defines the manufacturing criteria and the safety requirements of the equipment used in potentially explosive environments for presence of gas or flammable dusts, within the European Union.

The Directive provides the classification and marking of components to EN 60079 harmonized norms.



IECEX International Electrotechnical Commission Explosive

International program for the safety of the equipment installed in a potentially explosive atmosphere, required to access international markets. IECEX provides certification of conformity for electrical equipment and machinery to be used in potential explosive environments and it is based on IEC 60079 standards. The objective of the IECEX is to facilitate international trade of equipment for use in explosive atmospheres.



EAC Eurasian Certification

It is applicable to the Customs Union Territory Including Russia, Kazakhstan, Belarus, Armenia and Kyrgyzstan

It indicates the compliance with the Customs Union Technical Regulation TP TC 012/2011 "safety of equipment intended for use in explosive atmospheres" and it acknowledges the whole ATEX Directive 2014/34/EU.



PESO Petroleum and Explosive Safety Organization (earlier known as CCoE)

It approves products distributed within Indian territory for suitability in usage at petroleum or in any place with potentially explosive atmosphere. It is based on harmonized norms and international standards under ATEX and IECEX.

Atos multicertified ex-proof valves for gas group II are also certified Peso.



cULus North American Certification

It is a widely recognized certification across North America (US and Canada).

It provides certification of conformity for equipment and machinery installed in locations where explosion or fire hazards exist due to the presence of flammable gases, combustible dust, or ignitable fibers. It is based on NEC standards



MA safety certificate of approval for mining products

Chinese authority for certification of components operating in chinese coal mines.

It acknowledges the harmonized norms and international standards under ATEX and IECEX.

The following sections describe the various classifications related to hazardous environments according to certifications available for Atos components.

The classification is marked on the nameplate of each certified component to state its conformity to the specific hazardous environment and explosive atmosphere.



See section 4 for classifications to **ATEX, IECEX, EAC, PESO**



See section 5 for classifications to **cULus**

4 CLASSIFICATIONS TO ATEX, IECEx, EAC, PESO

The classifications reported in the following sections are those established by the EN and IEC standards related to ATEX and IECEx. EAC and PESO certifications acknowledge the same classification system of ATEX and IECEx. An example of classification present on the component nameplate is shown in the following:

environment			atmosphere			environment
II	2 G	Ex	d	IIC	T6/T5/T4	Gb
Group see sect. 4.1	Category see sect. 4.3	Mark of Explosion Proof	Protection Method see sect. 4.7	Gas Group see sect. 4.4	Temperature Class see sect. 4.6	Equipment Protection Level (EPL) see sect. 4.3

Once the user has classified the area in which the component is intended to be placed, he will be able to define the level of protection of the component.

The evaluation of the risk and consequentially the level of protection required by the equipment passes through two main classifications:

A- Environment: the classification is referred to the location in which the product is intended to be placed. Environment is further classified in **Group** and **Zone**.

B- Atmosphere: the classification is referred to the type of explosive substance present in the atmosphere. Atmosphere is further classified in **Gas Group**, **Dust Group** and **Temperature**.

A- ENVIRONMENT

4.1 Group classification

Explosive environments are classified into: **Group I** for underground mines or for surface equipments connected to mines. **Group II** for surface areas.

4.2 Zone classification - The Zone classification is not reported on the component nameplate

Explosive environments are classified into **Zone**, identified **0, 1, 2** for **Gas**, and **20, 21, 22** for **Dust**, depending on the time and frequency the explosive substance is present: Zone 2 and 22 are less dangerous than 0, 1 or 20, 21.

Components certified for Zone 0 (or 20) may also be used in Zone 1, 2 (or 21, 22).

4.3 Safety level required: Category and EPL

The Zone is directly linked with the safety level required; a zone with higher risk requires a higher safety level. There are two different classifications: **Category** and **EPL**.

Category: ATEX classifies the safety required level into **Category 1, 2, 3** accompanied with letter **G** for gas and letter **D** for Dust: Category 1G (or 1D) are safer than 2G, 3G (or 2D, 3D).

Components certified for Category 1 may also be used where Category 2 or 3 is needed.

For Group I the classification is **Category M1** or **M2** with M1 safer than M2.

EPL: IECEx classifies the safety level required into **Equipment Protection Level (EPL) a, b, c** anticipated by letter **G** for gas and **D** for dust depending on the safety level required: Category Ga (or Da) are safer than Gb, Gc (or Db, Dc).

Components certified for EPL Ga (or Da) may also be used where EPL Gb, Gc (or Db, Dc) is needed.

Environment classification

Explosive Atmosphere	Group see 4.1	Zone see 4.2	Safety level required see 4.3		Atos component
			Category	EPL	
Gas / Dust (mining)	I	-	M1	-	① ③
	I	-	M2		
Gas (surface)	II	0	1G	Ga	④
		1	2G	Gb	② ⑤ ⑥
		2	3G	Gc	② ⑤ ⑥
Dust (surface)	II	20	1D	Da	② ⑤ ⑥
		21	2D	Db	
	II	22	3D	Dc	② ⑤ ⑥

① Atos ex-proof (mining) ② Atos ex-proof (gas & dust) ③ Atos intrinsically safe (mining) ④ Atos intrinsically safe (gas)

⑤ Pumps and cylinders ⑥ Atos stainless steel ex-proof

4.4 Gas Group classification

The classification is based on the minimum ignition energy of the explosive atmosphere in which a component may be installed. The **Gas Groups** are identified **IIA, IIB, IIC** depending on the dangerousness of the substances: group IIA is less dangerous than group IIB and IIC. Components certified for Gas Group IIC may also be used in less dangerous Groups IIB and IIA

4.5 Dust group classification

The classification is based on nominal dimensions and electrical resistivity of particles. The **Dust Groups** are identified **IIIA, IIIB** and **IIIC**, depending on the dangerousness of the substances: group IIIC contains smaller and less electrically resistive substances than group IIIB and IIIA. Components certified for Dust Group IIIC may also be used in less dangerous Groups IIIB and IIIA.

4.6 Temperature class

Based on their maximum surface temperature, the components are classified into **Temperature Classes T1 to T6** for Gas, whereas for Dust the max surface temperature is directly reported in °C. The maximum surface temperature of the component must be lower than the ignition temperature of the surrounding explosive atmosphere. Components certified with Temperature Class T6 may also be used in lower Classes T5 to T1

Atmosphere and Temperature class

Gas Group	Gas type					
IIC	Hydrogen	Acetylene				Carbon disulphide
IIB	City gas Acrylic Nitrile	Ethylene	Ethyl glycol Carbon hydrogen	Ethyl ether		
IIA	Ammonia Methane Ethane Propane	Ethanol n-Butane	Petrol Diesel fuel Fuel oil n-Hexane	Acetal-dehyde		
Temperature class	T1 < 450°C	T2 < 300°C	T3 < 200°C	T4 < 135°C	T5 < 100°C	T6 < 85°C



Note: the Temperature class may change depending on the max ambient temperature where the component is installed. In this case two or three different T are reported on the components nameplate (i.e. T6/T5/T4). See technical table of each specific Atos component for Temperature class.

Dust Group	Dust type
IIIC	Conductive dust
IIIB	Non conductive dust
IIIA	Flammable fibers



For dust explosion proof, the max surface temperature is directly shown (e.g. T85°C)

4.7 Protection method

The ignition of the surrounding explosive atmosphere can be prevented adopting for the component a proper protection method. The protection method is directly linked to the design and manufacturing characteristics of the component. The table below reports the **Code** related to the protection method adopted along with the relative **Zone** of application.

Protection principle	Protection method	Code	Zone						Atos component	
			Gas			Dust				
			0	1	2	20	21	22		
Prevents transmission of the explosion outside	Flameproof enclosure	Ex	da	X	X	X	X	X	X	① ② ⑥
			db		X	X				
			dc			X				
Dust explosion proof	Protection by enclosure	Ex	ta				X	X	X	② ⑥
			tb					X	X	
			tc						X	
Low current / voltage supply	Intrinsically safe	Ex	ia	X	X	X				③ ④
			ib		X	X				
			tc			X				
Non-electrical	Construction safety Control of ignition sources Protection by liquid immersion	Ex	c b k		X	X		X	X	⑤

- ① Atos ex-proof (mining) ② Atos ex-proof (gas & dust) ③ Atos intrinsically safe (mining) ④ Atos intrinsically safe (gas)
 ⑤ Pumps and cylinders ⑥ Atos stainless steel ex-proof

4.8 Painting

According to EN60079-0 the valves can be coated with a non-metallic material (i.e. painting), observing the maximum thickness:

Group IIC < 0,2 mm max

Group IIB < 0,3 mm max

Group IIA < 0,3 mm max

5 CLASSIFICATIONS TO cULus



The classification of explosive environments in cULus certification is regulated by NEC Standards (National Electric Code) and it is based on NEC 500 and NEC 505 articles.

NEC 500 covers the requirements for the classification system in Classes I, II, III and Divisions 1 and 2.

NEC 505 covers the requirements for the classification system in Zones (Zone 0, 1, and 2) as alternative to the NEC 500.

An example of classification present on the component nameplate is shown in the following:

NEC 500

Class I	Division I	Groups C & D	T6/T5
see sect. 5.1	see sect. 5.3	Gas Groups see sect. 5.2	Temperature Class see sect. 5.5

NEC 505

Class I	Zone I	Groups IIA & IIB	T6/T5
see sect. 5.1	see sect. 5.4	Gas Groups see sect. 5.2	Temperature Class see sect. 5.5

5.1 Class classification - NEC 500 and NEC 505

Location where explosive substances are present in the atmosphere are classified as:

Class I where flammable vapors and gases may be present

Class II and **Class III** where combustible dust and easily ignitable fibers may be present

5.2 Group classification

NEC 500: based on the ignition temperatures and explosion pressure, NEC 500 classifies gases and dust into Groups, identifying **Group A, B, C, D** for **Gases** and **Group E, F, G** for **Dusts**. Group D (or G) is less dangerous than Groups A, B, C (or E, F). Components certified with Group A (or E) may also be used in lower Group B to D (or F to G).

NEC 505: the Gas Groups have the same classifications as per IECEx, as reported in the following table for comparison with NEC 500.

Explosive atmosphere	Typical hazard material	Class	Group		Atos component
			NEC 500	NEC 505	
Gases, vapors and liquids	Acetylene	Class I	A	IIC	①
	Hydrogen, Butadiene, Ethylene Oxide, Propylene Oxide	Class I	B	IIC or IIB+H2	
	Ethylene, Formaldehyde, Cyclopropane, Ethyl Ether, etc	Class I	C	IIB	
	Methane, Butane, Petrol, Natural gas, Propane, Gasoline	Class I	D	IIA	
Dusts	Metallic dusts (conductive and explosive)	Class II	E	IIIC	↑ HIGHER PROTECTION
	Coal dusts (some are conductive and all are explosive)	Class II	F	IIIC	
	Grain dust	Class II	G	IIIB	
Solid combustible, fibres and particles	Textile products, wood, paper, cotton processing (easily flammable, but does not risk to be explosive)	Class III	-	IIIA	↑ HIGHER PROTECTION

① Atos ex-proof /UL and Atos stainless steel ex-proof /UL

5.3 Division classification – only for NEC 500 Standard

Each of the three Classes described in section 5.1 is further subdivided into two Divisions:

Division 1 includes explosive substances that are continuously, intermittently or periodically present in the atmosphere.

The ignitable concentrations of above substances exist under normal conditions or it is caused by frequent maintenance or by equipment failure.

Division 2 includes explosive substances present under “unusual” circumstances.

Above substances are normally contained into sealed containers or into closed systems from which they can only escape through accidental rupture or breakdowns of such containers.

The installation and requirements for **Division 1** are more restrictive than for **Division 2**.

Components certified with Division 1 may also be used when Division 2 is required.

5.4 Zone classification – only for NEC 505 Standard

NEC 505 Standard introduces the Zone classification:

Zone 0 defines locations in which an explosive gas is present continuously or for long periods during normal operation.

Zone 1 defines locations in which ignitable concentrations of gas exist under normal operation or it is caused by frequent maintenance or equipment failure.

Zone 2 defines the area in which an explosive gas is not likely to occur or it will exist only for a short time

Component certified with Zone 0 may be used when Zone 1 is required.

The following table reports a comparison between Division classification to NEC 500 and Zone classification to NEC 505 Standards.

	Continuous Hazard	Intermittent hazard	Hazard under abnormal conditions
NEC 500	Division 1 ①		Division 2
NEC 505	Zone 0 (Zone 20 dust)	Zone 1 (Zone 21 dust) ①	Zone 2 (Zone 22 dust)

① Atos ex-proof /UL and Atos stainless steel ex-proof /UL

5.5 Temperature classes

The temperature classes designate the maximum operating temperatures of the equipment surface which must not exceed the ignition temperature of the surrounding atmosphere.

The temperature class is marked on the component nameplate.

Products certified with temperature class T6 may also be used in lower classes T5 to T1

Code	Max surface Temperature		Atos component
	[°C]	[°F]	
T6	85	185	①
T5	100	212	②
T4A	120	248	
T4	135	275	③
T3C	160	320	
T3B	165	329	
T3A	180	356	
T3	200	392	④ ⑤
T2D	215	419	
T2C	230	446	
T2B	260	500	
T2A	280	536	
T2	300	572	
T1	450	842	



Note:

the Temperature class may change depending on the max ambient temperature where the component is installed. In this case two different T are reported on the components nameplate (i.e. T6/T5). See technical table of each specific Atos component for Temperature Class.

① Atos ex-proof ON-OFF - Tamb up to +55°C
Atos stainless steel with ex-proof solenoid type OAX, OAXS

② Atos ex-proof ON-OFF - Tamb from +55°C to +70°C
Atos stainless steel with ex-proof solenoid type OAX, OAXS

⑤ Atos stainless steel with ex-proof solenoid type OAKX, OAKXS

③ Atos ex-proof proportionals - Tamb up to +55°C

④ Atos ex-proof proportionals - Tamb from +55°C to +70°C

6 ATEX vs. cULus (NEC)

The following tables report a comparison between ATEX and cULus (NEC) classification systems.

Note: due to the different nature ATEX and cULus systems, the direct comparison is not fully applicable. The comparison is just to be used as a general reference for transition from one system to the other.

6.1 Comparison concerning the classification of hazardous environments due to the presence of Gas or Dust

Gas

ATEX	Zone 0	Zone 1	Zone 2
cULus (NEC 505)	Zone 0	Zone 1	Zone 2
cULus (NEC 500)	Class I, Division I		Class I, Division 2

Dust

ATEX	Zone 20	Zone 21	Zone 22
cULus (NEC 505)	Zone 20	Zone 21	Zone 22
cULus (NEC 500)	Class II, Division I		Class II, Division 2

6.2 Comparison concerning the classification of Gas Groups

	Gas type			
	Propane	Ethylene	Hydrogen	Acetylene
ATEX	IIA	IIB	IIC	IIC
cULus (NEC 505)	IIA	IIB	IIC	IIC
cULus (NEC 500)	D	C	B	A

Note: the direct comparison concerning Dust Group is not possible since the classification criteria between ATEX and cULus are consistently different

6.3 Comparison concerning the Temperature Classes for Gas Group II

ATEX	cULus (NEC 505)	cULus (NEC 500)	Max surface temperature [°C]	Max surface temperature [°F]
T6	T6	T6	85	185
T5	T5	T5	100	212
		T4A	120	248
T4	T4	T4	135	275
		T3C	160	320
		T3B	165	329
		T3A	180	356
T3	T3	T3	200	392
		T2D	215	419
		T2C	230	446
		T2B	260	500
		T2A	280	536
T2	T2	T2	300	572
T1	T1	T1	450	842

7 ATOS COMPONENTS EXEMPTED FROM CERTIFICATION AND MARKING

Atos hydraulic components made only by mechanical parts and not equipped with electrical functions are exempted from certification because their functioning does not generate dangerous conditions for the explosive environment.

The safe application of these components in hazardous environments is justified by following analysis:

- All the internal parts of the components are separated and insulated from the external environment by means of pressure-proof seals. The internal volumes are filled by the hydraulic fluid, thus there are no volumes which can be saturated by the external explosive atmosphere.
- The operation of mechanical parts does not produce potential sources of ignition of the explosive gas mixture.
- The functioning of the mechanical parts does not create conditions as overheating which may cause the explosion of the surrounding atmosphere.

The following components are included in this range:

- On-off pressure control valves (without solenoid pilot) type CART-*, ARE, ARAM, AGAM, AGIR, AGIS, AGIU, REM
- Flow control valves type QV, AQFR
- Check valves type DB, DR, ADR, ADRL, AGR, AGRLE
- Modular valves type HMP, HM, KM, HS, KS, HG, KG, JPG, HC, KC, JPC, HQ, KQ, JPQ, HR, KR, JPR (modular fast/slow valves type DHQ and pressure switch type MAP, cannot be used in potentially explosive atmosphere)
- On off Mechanical, Hydraulic, Pneumatic operated valves
- On-off ISO cartridges, type SC LI and ISO functional covers without solenoid pilot valve.

8 INGRESS PROTECTION (IP)

The "Ingress Protection" identifies the environmental protection of a device defined in IEC Standard 60529.

The IP classification system designates, by means of two digits, the degree of protection provided by a device against ingress of dust and water.

FIRST	DEGREE OF PROTECTION AGAINST SOLID OBJECTS	SECOND	DEGREE OF PROTECTION AGAINST WATER	Atos component
0	Non-protected	0	Non-protected	
1	Protected against a solid object with diameter greater than 50 mm	1	Protected against water dripping vertically, such as condensation	
2	Protected against a solid object with diameter greater than 12 mm	2	Protected against dripping water when tilted up to 15°	
3	Protected against a solid object with diameter greater than 2.5 mm	3	Protected against water spraying at an angle of up to 60°	
4	Protected against a solid object with diameter greater than 1.0 mm	4	Protected against water splashing from any direction	
5	Dust-protected. Prevents ingress of dust sufficient to cause harm	5	Protected against jets of water from any direction	
6	Dust tight. No dust ingress	6	Protection against heavy seas or powerful jets of water	① ② ③
		7	Protected against harmful ingress of water when immersed between a depth of 150 mm to 1 meter	① ③
		8	Protected against submersion. Suitable for continuous immersion in water	

① Atos ex-proof multicertification (mining / surface) = IP66/67

② Atos intrinsically safe = IP66

③ Atos stainless steel ex-proof = IP66/67

The ingress protection of cULus certified components is "Raintight enclosure, UL approved"

8.1 Comparison between IEC and NEMA standards

An equivalent classification of the enclosures degrees of protection, for the USA market, is defined according to NEMA Standard.

Note: the direct comparison is not possible since the classification criteria are consistently different between IEC and NEMA.

The comparison is just to be used as a general reference for transition from one system to another.

NEMA	1	2	3	3X	3R	3RX	3S	3SX	4	4X	5	6	6P	12	12K	13
IEC (IP)	20	22	55		24		55		66		53	67	68	54		

Stainless steel ex-proof solenoid directional valves

on-off, direct, spool type - **ATEX, IECEx, EAC, PESO** or **cULus**

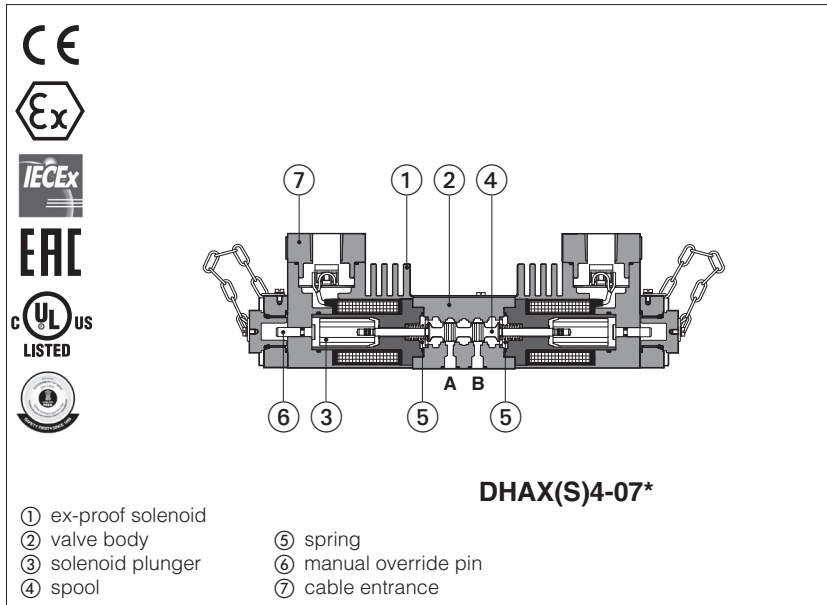

DHAX, DHAXS

Ex-proof, spool type, directional solenoid valves made in two different stainless steel executions for corrosive environments and fluids.

- X** full stainless steel for external and internal parts, to withstand extreme and corrosive environmental conditions, and to ensure full compatibility also with water base and special fluids.

- XS** stainless steel only for external parts to withstand extreme and corrosive environmental conditions.

Ex-proof stainless steel solenoids are provided, with **ATEX, IECEx, EAC, PESO Multicertification** or **cULus** North American certification, see section 8.

DHAX and DHAXS are **SIL** compliance with IEC 61508 (TÜV certified)

Size: **06** - ISO 4401

4/3 and 4/2 way

Max flow: up to **70 l/min**

Max pressure: **350 bar**

1 MODEL CODE

DHA	X	4	/	*	-	0	63	/	1/2	/	M	/	V	24DC	/	*	/	*
<p>Ex-proof solenoid directional valve, direct, spool type</p> <p>Stainless steel executions (1) X = full stainless steel XS = stainless steel only external parts</p> <p>Solenoid power and Temperature class, see also certification data in section 8 (2):</p> <p>Multicertification 4 = 25W, class T4/T3 6 = 8W, class T6/T4 (only XS execution)</p> <p>cULus 4 = 33W, class T3 6 = 12W, class T6/T5</p> <p>Certification type: - = omit for Multicertification (Group II)</p> <p>North American Certification: UL = cULus</p> <p>Valve size (ISO 4401): 0 = 06</p> <p>Configuration, see section 2: 61, 63, 71, 75</p>																		<p>Test fluid, only for X execution (3): H = mineral oil W = pure water</p> <p>Seals material, see section 6: - = NBR low temp. -40°C PE = FKM BBT = FVMQ fluorosilicon -60°C (4)</p> <p>Series number</p> <p>Voltage code, see section 5</p> <p>Options, see section 13 for possible combined option: A = solenoid at side of port B O = horizontal cable entrance V = with handwheel manual override</p> <p>Solenoid threaded connection for cable gland fitting: M = M20x1,5 for Multicertification NPT = 1/2" NPT for UL</p>

(1) See section 6 for materials specification.

(2) 6 and 4 versions differ only for the coil power, see power consumption at section 5 and operating limits at section 15.

(3) DHAX valves in full stainless steel execution are factory tested with mineral oil or pure water in order to avoid the contamination of the end user system.

At the end of each valve model code must be specified the type of fluid to be used in the valve's testing: "H" for hydraulic oil or "W" for pure water.

(4) Only for Multicertified valves in full stainless steel "X" execution (not available for valves with UL certification)

1.1 Summary of available models

Valve execution		Multicertification		cULus		Max flow (l/min)	Max pressure (bar)
X	XS	Tclass	Power	Tclass	Power		
DHAX4	DHAXS4	T4, T3	25W	T3	33W	70	350
-	DHAXS6	T6, T4	8W	T6, T5	12W	60	

2 CONFIGURATIONS AND SPOOLS (representation according to ISO 1219-1)

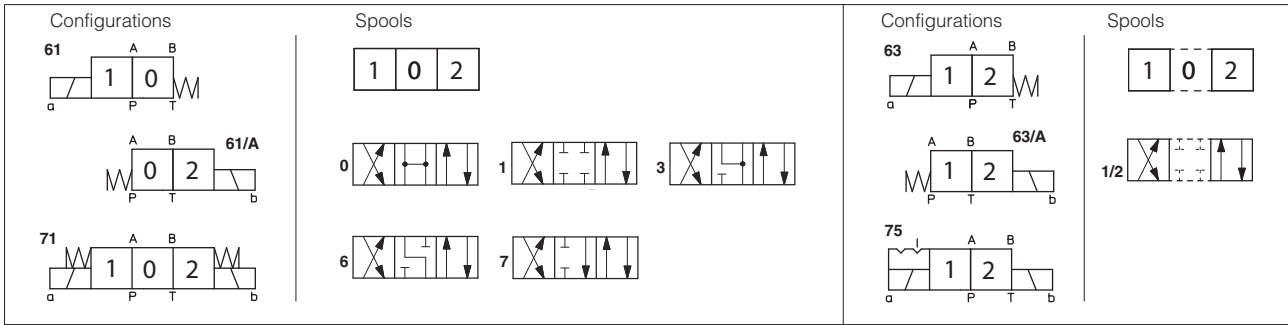

3 GENERAL CHARACTERISTICS

Assembly position / location	Any position
Subplate surface finishing	Roughness index Ra 0,4 - flatness ratio 0,01/100 (ISO 1101)
MTTFd values according to EN ISO 13849	150 years, for further details see technical table P007
Ambient temperature	Standard = -40°C ÷ +70°C /PE option = -20°C ÷ +70°C /BBT option = -60°C ÷ +70°C
Storage temperature range	Standard = -40°C ÷ +80°C /PE option = -20°C ÷ +80°C /BBT option = -60°C ÷ +80°C
Compliance	Explosion proof protection, see section 8 -Flame proof enclosure "Ex d" -Dust ignition protection by enclosure "Ex t" SIL to IEC 61508: 2010, see section 9 RoHs Directive 2011/65/EU as last update by 2015/65/EU REACH Regulation (EC) n°1907/2006

4 HYDRAULIC CHARACTERISTICS

Max operating pressure	Ports P,A,B: 350 bar; Port T 210 bar
Rated flow	See diagrams Q/Δp at section 14
Max flow	DHAX4 = 70 l/min DHAXS4 = 70 l/min DHAXS6 = 60 l/min See operating limits at section 15

The pressure at T port makes difficult the manual override operation that can be possible only if its value is lower than 50 bar

5 ELECTRICAL CHARACTERISTICS

Valve type	DHAX4 DHAXS4	DHAXS6	DHAX4/UL DHAXS4/UL	DHAXS6/UL
Voltage code (1) $V_{DC} \pm 10\%$	12DC, 24DC, 48DC, 110DC, 125DC, 220DC		12DC, 24DC, 110DC, 125DC, 220DC	
$V_{AC} 50/60 \text{ Hz} \pm 10\%$	12AC, 24AC, 110AC, 230AC		12AC, 24AC, 110AC, 230AC	
Power consumption at 20°C	25W	8W	33W	12W
Coil insulation	class H			
Protection degree with relevant cable gland	IP66/67 to DIN EN60529		raintight enclosure, UL approved	
Duty factor	100%			

(1) For alternating current supply a rectifier bridge is provided built-in the solenoid.
For power supply frequency 60 Hz, the nominal supply voltage of solenoids 110AC and 230AC must be 115/60 and 240/60 respectively

6 MATERIALS SPECIFICATION

Valve code	Solenoid housing	Valve body	Internal parts	Spring	Seals		
					std	/PE	/BBT
DHAX	AISI 630	AISI 316L	AISI 316L, 420B, 440C, 430F	AISI 302	NBR 70 Sh low temp	FKM (viton)	FMVQ (fluorosilicon)
DHAXS	AISI 630	AISI 316L	Carbon steel	AISI 302	NBR 70 Sh low temp	FKM (viton)	-

7 SEALS AND HYDRAULIC FLUIDS - for other fluids not included in below table, consult our technical office

Seals, recommended fluid temperature (1)	NBR low temp. seals (standard) = -40°C ÷ +60°C FKM seals (/PE option) = -20°C ÷ +80°C FVMQ seals (/BBT option) = -60°C ÷ +60°C		
Recommended viscosity	15 ÷ 100 mm ² /s - max allowed range 2.8 ÷ 500 mm ² /s min = 0,9 mm ² /s for X full stainless steel execution with pure water		
Max fluid contamination level	ISO4406 class 20/18/15 NAS1638 class 9, see also filter section at www.atos.com or KTF catalog		
Hydraulic fluid	Suitable seals type	Classification	Ref. Standard
Mineral oils	NBR low temp., FKM, FVMQ	HL, HLP, HLPD, HVLP, HVLDP	DIN 51524
Flame resistant without water	FKM, FVMQ	HFDU, HFDR	ISO 12922
Flame resistant with water (2)	NBR low temp.	HFA-E, HFA-S, HFB, HFC	

(1) The operating temperature of the fluid must be compatible with the maximum viscosity range allowed for the valve

(2) Performance limitations in case of flame resistant fluids with water:

-max operating pressure = 210 bar -max fluid temperature = 50°C

 The ignition temperature of the hydraulic fluid must be 50°C higher than the max solenoid surface temperature

8 CERTIFICATION DATA

8.1 Certification data for ambient temperature range -40 ÷ +70°C

Valve type	DHAX4 DHAXS4		DHAXS6		DHAX4/ UL DHAXS4/ UL		DHAXS6/ UL	
Certifications	Multicertification Group II ATEX IECEx EAC PESO				North American cULus			
Solenoid certified code	OAKX/WP OAKXS/WP		OAXS/WP		OAKX/EC/WP OAKXS/EC/WP		OAXS/EC/WP	
Temperature class	T4	T3	T6	T4	T3	T6	T5	
Surface temperature	≤ 85 °C	≤ 135 °C	≤ 85 °C	≤ 135 °C	≤ 200 °C	≤ 85 °C	≤ 100 °C	
Ambient temperature	-40 ÷ +45 °C	-40 ÷ +70 °C	-40 ÷ +45 °C	-40 ÷ +70 °C	-40 ÷ +70 °C	-40 ÷ +55 °C	-40 ÷ +70 °C	

8.2 Certification data for ambient temperature range -60 ÷ +70°C (valves with option /BBT)

Valve type	DHAX4 / BBT	
Certifications	Multicertification Group II ATEX IECEx EAC PESO	
Solenoid certified code	OABKX/WP	
Temperature class	T4	T3
Surface temperature	≤ 85 °C	≤ 135 °C
Ambient temperature	-60 ÷ +45 °C	-60 ÷ +70 °C

8.3 Certificates and applicable standards

Certifications	Multicertification Group II ATEX IECEx EAC PESO		North American cULus	
Type examination certificate (1)	ATEX: CESI 02 ATEX 014 IECEX: IECEX CES 10.0010x EAC: TC RU C-IT. 08.B.01784 PESO: P391133/1		20170324 - E366100	
Method of protection	<ul style="list-style-type: none"> • ATEX, EAC Ex II 2G Ex d IIC T6/T4/T3 Gb Ex II 2D Ex tb IIIC T85°C/T200°C Db • IECEx Ex db IIC T6/T4/T3 Gb Ex tb IIIC T85°C/T200°C Db • PESO Ex II 2G Exd IIC T6/T4/T3 Gb 		<ul style="list-style-type: none"> • UL 1203 Class I, Div.I, Groups C & D Class I, Zone I, Groups IIA & IIB 	
Applicable standards	EN 60079-0 EN 60079-1 EN 60079-31		IEC 60079-0 IEC 60079-1 IEC 60079-31	
Cable entrance:	M20x1,5		1/2" NPT ANSI/ASME B46.1	

(1) The type examiner certificates can be downloaded from www.atos.com

 **WARNING: service work performed on the valve by the end users or not qualified personnel invalidates the certification**

9 SIL compliance with IEC 61508: 2010

DHAX and DHAXS meets the requirements of:

- **SC3** (systematic capability)
- max **SIL 2** (HFT = 0 if the hydraulic system does not provide the redundancy for the specific safety function where the component is applied)
- max **SIL 3** (HFT = 1 if the hydraulic system provides the redundancy for the specific safety function where the component is applied)

10 EX PROOF SOLENOIDS WIRING

Multicertification

Standard version **Option /O**

- ① cover with threaded connection for vertical cable gland fitting
- ② cover with threaded connection for horizontal cable gland fitting
- ③ terminal board for cables wiring
- ④ standard manual override protected by cap
- ⑤ screw terminal for additional equipotential grounding

○	○	○
○	○	○
○	○	○

1 = Coil PCB 3 poles terminal board suitable for wires cross sections up to 2,5 mm² (max AWG14)
 2 = GND
 3 = Coil

cULus certification

Standard version **Option /O**

- ① cover with threaded connection for vertical cable gland fitting
- ② cover with threaded connection for horizontal cable gland fitting
- ③ terminal board for cables wiring
- ④ standard manual override protected by cap

! Pay attention to respect the polarity

○	○	○
○	○	○
○	○	○

1 = Coil + PCB 3 poles terminal board suggested cable section up to 1,5 mm²
 2 = GND
 3 = Coil - (max AWG16), see section 11 note 1

alternative GND screw terminal connected to solenoid housing

11 CABLE SPECIFICATION AND TEMPERATURE

<p>Multicertification</p> <p>Power supply: section of coil connection wires = 2,5 mm²</p>	<p>Grounding: section of internal ground wire = 2,5 mm² section of external ground wire = 4 mm²</p>
<p>cULus certification:</p> <ul style="list-style-type: none"> • Suitable for use in Class I Division 1, Gas Groups C • Armored Marine Shipboard Cable which meets UL 1309 • Tinned Stranded Copper Conductors • Bronze braided armor • Overall impervious sheath over the armor 	<p>Any Listed (UBVZ/ UBVZ7) Marine Shipboard Cable rated 300 V min, 15A min. 3C 2,5 mm² (14 AWG) having a suitable service temperature range of at least -40°C to +110°C</p> <p>Note 1: For Class I wiring the 3C 1,5 mm² AWG 16 cable size is admitted only if a fuse lower than 10 A is connected to the load side of the solenoid wiring.</p>

11.1 Cable temperature

The cable must be suitable for the working temperature as specified in the "safety instructions" delivered with the first supply of the products.

Multicertification

Solenoid code	Max ambient temperature [°C]	Temperature class	Max surface temperature [°C]	Min cable temperature
OA(B)X OA(B)XS	45 °C	T6	85 °C	not prescribed
	70 °C	T4	135 °C	90 °C
OA(B)KX OA(B)KXS	45 °C	T4	85 °C	100 °C
	50 °C	T3	200 °C	100 °C
	60 °C	T3	200 °C	120 °C
	70 °C	T3	200 °C	130 °C

cULus certification

Solenoid code	Max ambient temperature [°C]	Temperature class	Max surface temperature [°C]	Min cable temperature
OAX/EC OAXS/EC	55 °C	T6	85 °C	100 °C
	70 °C	T5	100 °C	100 °C
OAKX/EC OAKXS/EC	55 °C	T3	200 °C	115 °C
	70 °C	T3	200 °C	140 °C

12 CABLE GLANDS - only **Multicertification**

Cable glands with threaded connections M20x1,5 for standard or armoured cables have to be ordered separately, see tech. table **KX800**

Note: a Loctite sealant type 545, should be used on the cable gland entry threads

13 OPTIONS

- A** = solenoid at side of port B (for single solenoid valves)
- O** = horizontal cable entrance , to be selected in case of limited vertical space
- V** = with handweel manual override

13.1 Possible combined options

AO, AV, OV, AOV

14 Q/Δp DIAGRAMS (based on mineral oil ISO VG 46 at 50°C)

Spool type	Flow direction				
	P→A	P→B	A→T	B→T	P→T
0	A	A	B	B	C
1	C	B	B	B	
3	C	C	A	A	
1/2	C	C	C	C	
6, 7	C	C	C	C	

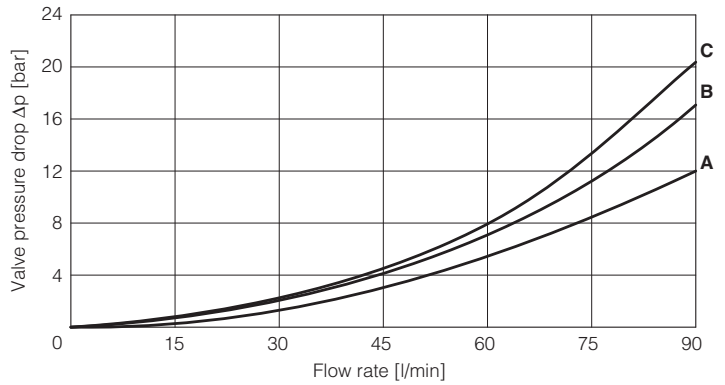

15 OPERATING LIMITS (based on mineral oil ISO VG 46 at 50°C)

The diagram have been obtained with warm solenoids and power supply at lowest value ($V_{nom} - 10\%$). The curves refer to application with symmetrical flow through the valve (i.e. P → A and B → T). In case of asymmetric flow the operating limits must be reduced.

Valve type	Curve	Spool type
DHAX4	A	0, 1
	B	3
	C	1/2
	D	6, 7

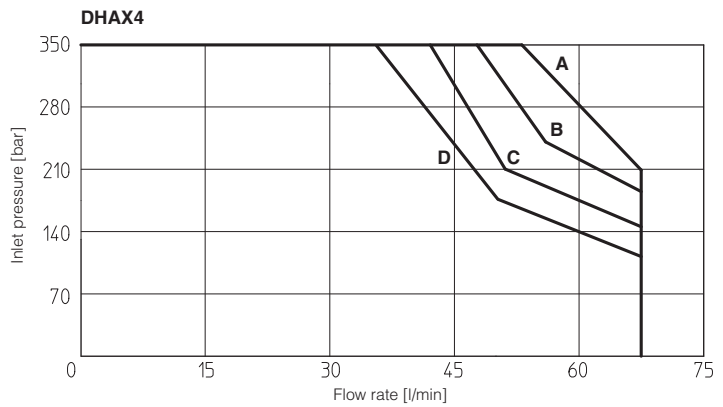

Valve type	Curve	Spool type
DHAXS4	A	0, 1, 3
	B	1/2
	C	6, 7

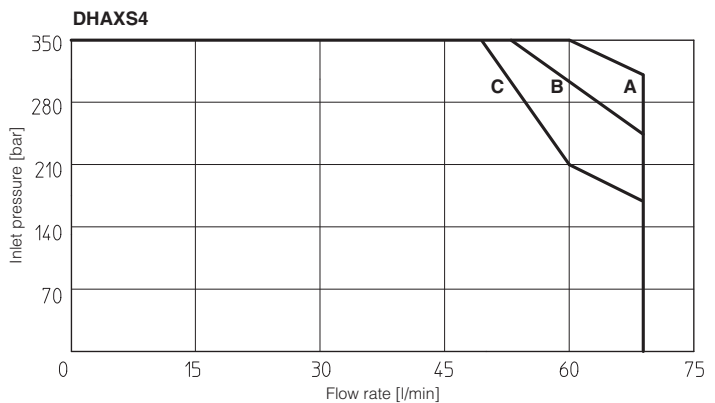

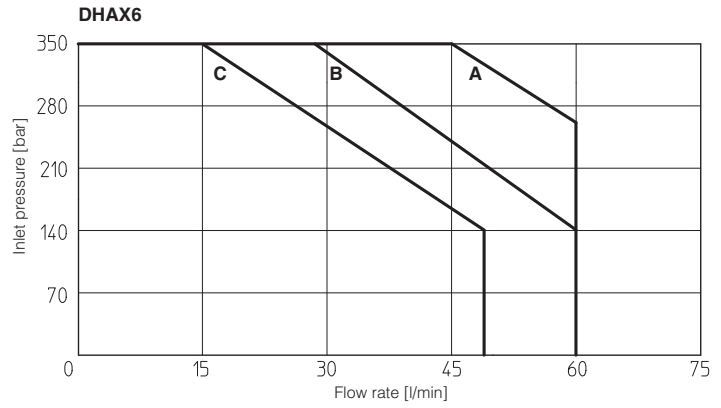

Valve type	Curve	Spool type
DHAX6	A	0
	B	1, 1/2
	C	3, 6, 7

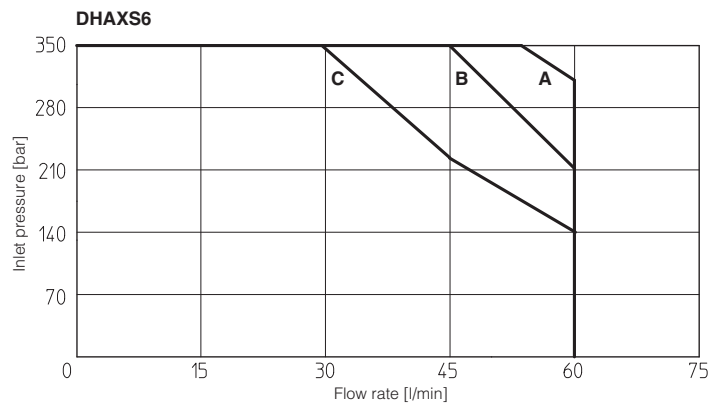

Valve type	Curve	Spool type
DHAXS6	A	0
	B	1, 1/2
	C	3, 6, 7

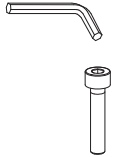

16 FASTENING BOLTS AND SEALS

	<p>DHAX, DHAXS</p> <p>Fastening bolts: 4 socket head screws M5x50-A4-70 Tightening torque = 5,5 Nm</p>
	<p>Seals: 4 OR 108; Diameter of ports P, A, B, T: Ø 7,5 mm (max)</p>

17 INSTALLATION DIMENSIONS [mm]

ISO 4401: 2005

Mounting surface: 4401-03-02-0-05

Mass [kg]	
DHAX(S)**-06*	2,9
DHAX(S)**-06*/V	3
DHAX(S)**-07*	4,6
DHAX(S)**-07*/V	4,8
Option /O	+0,35

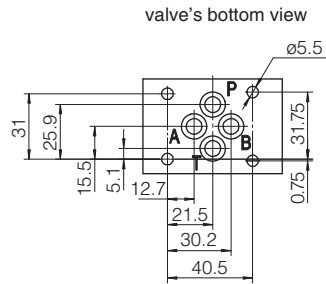

P = PRESSURE PORT
A, B = USE PORT
T = TANK PORT

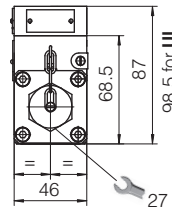
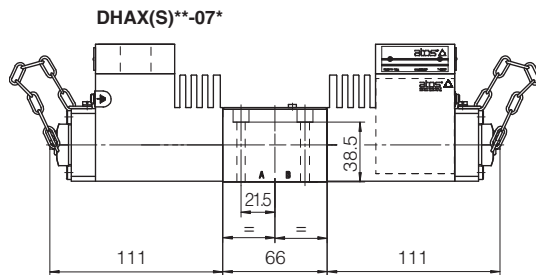
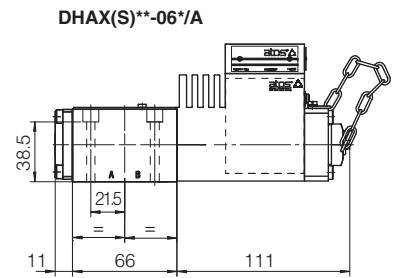
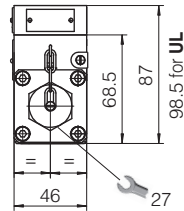
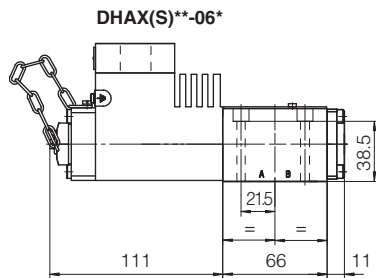

handwheel manual override option /V

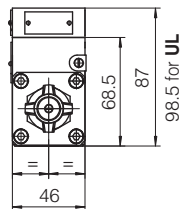
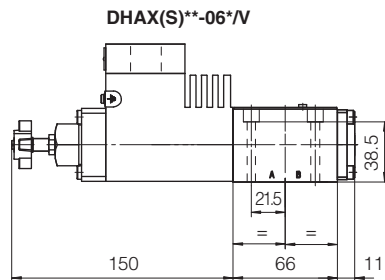

horizontal cable entrance option /O

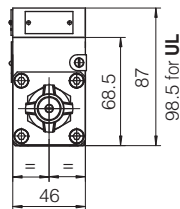
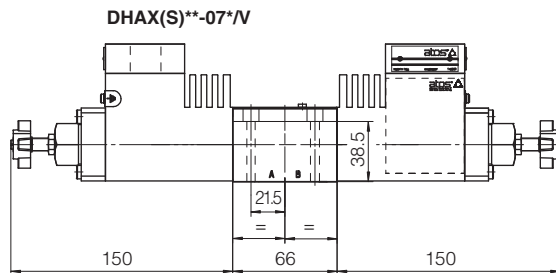
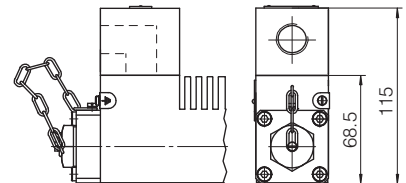

18 RELATED DOCUMENTATION

W010 Basics for electrohydraulics in corrosive environments

W020 Summary of Atos stainless steel components

EW900 Operating and maintenance information for stainless steel on-off valves

X010 Basics for electrohydraulics in hazardous environments

KX800 Cable glands for ex-proof valves

Stainless steel ex-proof solenoid directional valves

on-off, direct, poppet type leak free - **ATEX, IECEx, EAC, PESO** or **cULus**

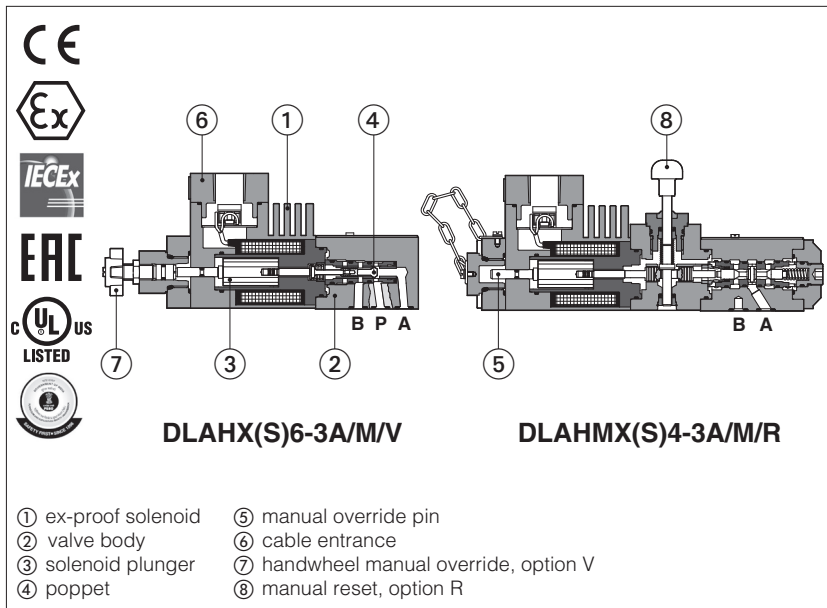

DLAHX, DLAHXS, DLAHM(S), DLAHMS(S)

Ex-proof, poppet type, directional solenoid valves made in two different stainless steel executions for corrosive environments and fluids.

- X** full stainless steel for external and internal parts, to withstand extreme and corrosive environmental conditions, and to ensure full compatibility also with water base and special fluids.
- XS** stainless steel only for external parts to withstand extreme and corrosive environmental conditions.

Ex-proof stainless steel solenoids are provided with **ATEX, IECEx, EAC, PESO Multicertification** or **cULus** North American certification, see section 8.

DLAHX and DLAHXS are **SIL** compliance with IEC 61508 (TUV certified)

DLAHX(S):	DLAHMS(S):
Size: 06 - ISO 4401	Size: 06 - ISO 4401
3/2 way	3/2 way
Max flow: 12 l/min	Max flow: 30 l/min
Max pressure: 350 bar	Max pressure: 315 bar

1 MODEL CODE

DLAH	X	6	*	-	3	A	M	V	24DC	*	*	*
Ex-proof solenoid directional valve, leak free DLAH = max flow 12 l/min DLAHS = max flow 30 l/min												Test fluid , only for X execution (3): H = mineral oil W = pure water
Stainless steel executions (1): X = full stainless steel XS = stainless steel only external parts												Seals material , see section 6: - = NBR low temp. -40°C PE = FKM BBT = FVMQ fluorosilicon -60°C (4)
Solenoid power and Temperature class , see also certification data in section 8 (2): Multicertification 4 = 25W, class T4/T3 6 = 8W, class T6/T4 cULus 4 = 33W, class T3 6 = 12W, class T6/T5												Voltage code - see section 5
Certification type : - = omit for Multicertification (Group II) /UL = cULus certification												Options - see section 13 for possible combined options: O = horizontal cable entrance R = solenoid manual reset (not combinable with V) V = handwheel manual override (not combinable with R)
3 = three way												Solenoid threaded connection for cable gland fitting: M = M20x1,5 for Multicertification NPT = 1/2" NPT for /UL
(1) See section 6 for materials specification.												Valve configuration - see section 2: A = A to T in rest position C = P to A in rest position - P to B for DLAHS(S)

- (1) See section 6 for materials specification.
 (2) 6 and 4 versions differ only for the coil power, see power consumption at section 5 and operating limits at section 15.
 (3) The "X" valves in full stainless steel execution are factory tested by Atos with mineral oil or pure water in order to avoid the contamination of the end user system. At the end of each valve model code must be specified the type of fluid to be used in the valve's testing: "H" for hydraulic oil or "W" for pure water.
 (4) Only for Multicertified valves in full stainless steel "X" execution (not available for valves with UL certification)

1.1 Summary of available models

Valve execution		Multicertification		cULus		Max flow (l/min)	Max pressure (bar)
X	XS	Tclass	Power	Tclass	Power		
DLAHX4	DLAHS4	T4, T3	25W	T3	33W	12	350
DLAHX6	DLAHS6	T6, T4	8W	T6, T5	12W	10	315, 350
DLAHS4	DLAHS4	T4, T3	25W	T3	33W	25, 30	315
-	DLAHS6	T6, T4	8W	T6, T5	12W	25	250

2 CONFIGURATIONS AND HYDRAULIC SYMBOLS (representation according to ISO 1219-1)



3 GENERAL CHARACTERISTICS

Assembly position / location	Any position
Subplate surface finishing	Roughness index Ra 0,4 - flatness ratio 0,01/100 (ISO 1101)
MTTFd values according to EN ISO 13849	150 years, for further details see technical table P007
Ambient temperature	Standard = -40°C ÷ +70°C /PE option = -20°C ÷ +70°C /BBT option = -60°C ÷ +70°C
Storage temperature range	Standard = -40°C ÷ +80°C /PE option = -20°C ÷ +80°C /BBT option = -60°C ÷ +80°C
Compliance	Explosion proof protection, see section 8 -Flame proof enclosure "Ex d" -Dust ignition protection by enclosure "Ex t" SIL to IEC 61508: 2010, see section 9 (only for DLAHX and DLAHXS) RoHS Directive 2011/65/EU as last update by 2015/65/EU REACH Regulation (EC) n°1907/2006

4 HYDRAULIC CHARACTERISTICS

Valve type	DLAHX4 DLAHXS4	DLAHX6	DLAHXS6	DLAHMX4	DLAHMXS4	DLAHMXS6
Valve size	06	06	06	06	06	06
Max operating pressure: ports P, A, B [bar]	350	315	350	315	315	250
port T [bar]	110					
Rated flow	see diagrams Q/Δp at section 14					
Max flow (1) [l/min]	12	10	25	30	30	25
Internal leakage [cm³/min]	less than 5 drops/min (0,36 cm³/min) at max pressure					

(1) see diagram at section 15

⚠ The pressure at T port makes difficult the manual override operation that can be possible only if its value is lower than 50 bar

5 ELECTRICAL CHARACTERISTICS

Valve type	DLAHX4 DLAHXS4 DLAHMX4 DLAHMXS4	DLAHX6 DLAHXS6 DLAHMXS6	DLAHX4/UL DLAHXS4/UL DLAHMX4/UL DLAHMXS4/UL	DLAHX6/UL DLAHXS6/UL DLAHMXS6/UL
Voltage code (1) VDC ±10%	12DC, 24DC, 48DC, 110DC, 125DC, 220DC		12DC, 24DC, 110DC, 125DC, 220DC	
VAC 50/60 Hz ±10%	12AC, 24AC, 110AC, 230AC		12AC, 24AC, 110AC, 230AC	
Power consumption at 20°C	25W	8W	33W	12W
Coil insulation	class H			
Protection degree with relevant cable gland	IP66/67 to DIN EN60529		raintight enclosure, UL approved	
Duty factor	100%			

(1) For alternating current supply a rectifier bridge is provided built-in the solenoid.

For power supply frequency 60 Hz, the nominal supply voltage of solenoids 110AC and 230AC must be 115/60 and 240/60 respectively

6 MATERIALS SPECIFICATION

Valve code	Solenoid housing	Valve body	Internal parts	Spring	Seals		
					std	/PE	/BBT
DLAHX	AISI 630	AISI 316L	AISI 316L, 420B, 440C, 430F	AISI 302	NBR 70 Sh low temp	FKM (viton)	FMVQ (fluorosilicon)
DLAHXS	AISI 630	AISI 630	Carbon steel	AISI 302	NBR 70 Sh low temp	FKM (viton)	-
DLAHMX	AISI 630	AISI 630	AISI 316L, 420B, 440C, 430F	AISI 302	NBR 70 Sh low temp	FKM (viton)	FMVQ (fluorosilicon)
DLAHMXS	AISI 630	AISI 630	Carbon steel	AISI 302	NBR 70 Sh low temp	FKM (viton)	-

7 SEALS AND HYDRAULIC FLUIDS - for other fluids not included in below table, consult our technical office

Seals, recommended fluid temperature (1)	NBR seals (standard) = -40°C ÷ +60°C FKM seals (/PE option) = -20°C ÷ +80°C FVMQ seals (/BBT option) = -60°C ÷ +60°C		
Recommended viscosity	15 ÷ 100 mm ² /s - max allowed range 2.8 ÷ 500 mm ² /s		
Max fluid contamination level	15 ÷ 100 mm ² /s - max allowed range 2.8 ÷ 500 mm ² /s min = 0,9 mm ² /s for X full stainless steel execution with pure water		
Hydraulic fluid	Suitable seals type	Classification	Ref. Standard
Mineral oils	NBR low temp., FKM, FVMQ	HL, HLP, HLPD, HVLP, HVLPD	DIN 51524
Flame resistant without water	FKM, FVMQ	HFDU, HFDR	ISO 12922
Flame resistant with water (2)	NBR low temp.	HFA-E, HFA-S, HFB, HFC	

(1) The operating temperature of the fluid must be compatible with the maximum viscosity range allowed for the valve

(2) Performance limitations in case of flame resistant fluids with water:

-max operating pressure = 210 bar -max fluid temperature = 50°C

 The ignition temperature of the hydraulic fluid must be 50°C higher than the max solenoid surface temperature

8 CERTIFICATION DATA

8.1 Certification data for ambient temperature range -40 ÷ +70°C

Valve type	DLAHX4, DLAHXS4 DLAHMX4, DLAHMXS4	DLAHX6, DLAHXS6 - , DLAHMXS6	DLAHX4/UL, DLAHXS4/UL DLAHMX4/UL, DLAHMXS4/UL	DLAHX6/UL, DLAHXS6/UL - , DLAHMXS6/UL
Certifications	Multicertification ATEX IECEx EAC PESO			North American cULus
Solenoid certified code	OAKX/WP OAKXS/WP	OAX/WP OAXS/WP	OAKX/EC/WP OAKXS/EC/WP	OAX/EC/WP OAXS/EC/WP
Temperature class	T4	T3	T6	T4
Surface temperature	≤ 135 °C	≤ 200 °C	≤ 85 °C	≤ 135 °C
Ambient temperature	-40 ÷ +45 °C	-40 ÷ +70 °C	-40 ÷ +45 °C	-40 ÷ +70 °C
			-40 ÷ +70 °C	-40 ÷ +55 °C -40 ÷ +70 °C

8.2 Certification data for ambient temperature range -60 ÷ +70°C (valves with option /BBT)

Valve type	DLAHX4 /BBT DLAHMX4 /BBT	DLAHX6 /BBT
Certifications	Multicertification ATEX IECEx EAC PESO	
Solenoid certified code	OABKX/WP	OABX/WP
Temperature class	T4	T3
Surface temperature	≤ 135 °C	≤ 200 °C
Ambient temperature	-60 ÷ +45 °C	-60 ÷ +70 °C
		-60 ÷ +45 °C -60 ÷ +70 °C

8.3 Certificates and applicable standards

Certifications	Multicertification Group II ATEX IECEx EAC PESO	North American cULus
Type examination certificate (1)	ATEX: CESI 02 ATEX 014 IECEX: IECEX CES 10.0010x EAC: TC RU C-IT. 08.B.01784 PESO: P391133/1	20170324 - E366100
Method of protection	<ul style="list-style-type: none"> • ATEX, EAC Ex II 2G Ex d IIC T6/T4/T3 Gb Ex II 2D Ex tb IIIC T85°C/T200°C Db • IECEX Ex db IIC T6/T4/T3 Gb Ex tb IIIC T85°C/T200°C Db • PESO Ex II 2G Exd IIC T6/T4/T3 Gb 	<ul style="list-style-type: none"> • UL 1203 Class I, Div.I, Groups C & D Class I, Zone I, Groups IIA & IIB
Applicable standards	EN 60079-0 EN 60079-1 EN 60079-31	IEC 60079-0 IEC 60079-1 IEC 60079-31
Cable entrance:	M20x1,5	1/2" NPT ANSI/ASME B46.1

(1) The type examiner certificates can be downloaded from www.atos.com

 **WARNING: service work performed on the valve by the end users or not qualified personnel invalidates the certification**

9 SIL compliance with IEC 61508: 2010 - only DLAHX and DLAHXS

DLAHX and DLAHXS meet the requirements of:

- **SC3** (systematic capability)
- max **SIL 2** (HFT = 0 if the hydraulic system does not provide the redundancy for the specific safety function where the component is applied)
- max **SIL 3** (HFT = 1 if the hydraulic system provides the redundancy for the specific safety function where the component is applied)

10 EX PROOF SOLENOIDS WIRING

Multicertification

Standard version **Option /O**

① cover with threaded connection for vertical cable gland fitting
 ② cover with threaded connection for horizontal cable gland fitting
 ③ terminal board for cables wiring
 ④ standard manual override protected by cap
 ⑤ screw terminal for additional equipotential grounding

1 = Coil PCB 3 poles terminal board suitable for wires cross sections up to 2,5 mm² (max AWG14)
2 = GND
3 = Coil

cULus certification

Standard version **Option /O**

① cover with threaded connection for vertical cable gland fitting
 ② cover with threaded connection for horizontal cable gland fitting
 ③ terminal board for cables wiring
 ④ standard manual override protected by cap

⚠ **Pay attention to respect the polarity**

1 = Coil + PCB 3 poles terminal board suggestion
2 = GND - shielded cable section up to 1,5 mm²
3 = Coil - (max AWG16), see section 11 note 1
 alternative GND screw terminal connected to solenoid housing

11 CABLE SPECIFICATION AND TEMPERATURE - Power supply and grounding cables have to comply with following characteristics:

<p>Multicertification Power supply: section of coil connection wires = 2,5 mm²</p>	<p>Grounding: section of internal ground wire = 2,5 mm² section of external ground wire = 4 mm²</p>
<p>cULus certification:</p> <ul style="list-style-type: none"> • Suitable for use in Class I Division 1, Gas Groups C • Armored Marine Shipboard Cable which meets UL 1309 • Tinned Stranded Copper Conductors • Bronze braided armor • Overall impervious sheath over the armor <p>Any Listed (UBVZ/UBVZ7) Marine Shipboard Cable rated 300 V min, 15A min. 3C 2,5 mm² (14 AWG) having a suitable service temperature range of at least -40°C to +110°C</p> <p>Note 1: For Class I wiring the 3C 1,5 mm² AWG 16 cable size is admitted only if a fuse lower than 10 A is connected to the load side of the solenoid wiring.</p>	

11.1 Cable temperature

The cable must be suitable for the working temperature as specified in the "safety instructions" delivered with the first supply of the products.

Multicertification

Solenoid code	Max ambient temperature [°C]	Temperature class	Max surface temperature [°C]	Min cable temperature
OA(B)X OA(B)XS	45 °C	T6	85 °C	not prescribed
	70 °C	T4	135 °C	90 °C
OA(B)KX OA(B)KXS	45 °C	T4	85 °C	100 °C
	50 °C	T3	200 °C	100 °C
	60 °C	T3	200 °C	120 °C
	70 °C	T3	200 °C	130 °C

cULus certification

Solenoid code	Max ambient temperature [°C]	Temperature class	Max surface temperature [°C]	Min cable temperature
OAX/EC OAXS/EC	55 °C	T6	85 °C	100 °C
	70 °C	T5	100 °C	100 °C
OAKX/EC OAKXS/EC	55 °C	T3	200 °C	115 °C
	70 °C	T3	200 °C	140 °C

12 CABLE GLANDS - only Multicertification

Cable glands with threaded connections M20x1,5 for standard or armoured cables have to be ordered separately, see tech. table **KX800**

Note: a Loctite sealant type 545, should be used on the cable gland entry threads

13 OPTIONS

O = horizontal cable entrance, to be selected in case of limited vertical space

R = the R device operates as a security (not combinable with /V).

When the valve is electrically energized, the manual reset knob must be manually lifted at the same time in order to permit the poppet to move from the rest position to the switched position. The return of the valve to the rest position does not require lifting the manual reset knob.

V = with handwheel manual override (not combinable with /R)

Option /R

Lift to permit the valve switching

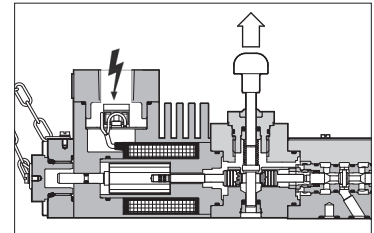

13.1 Possible combined options

OR, OV

14 Q/Δp DIAGRAMS (based on mineral oil ISO VG 46 at 50°C)

Valve type	Curve	Flow direction
DLAHX(S)-3A	C	P-A, P-B
	B	A-T, B-T
DLAHX(S)-3C	B	P-A, P-B
	A	A-T, B-T

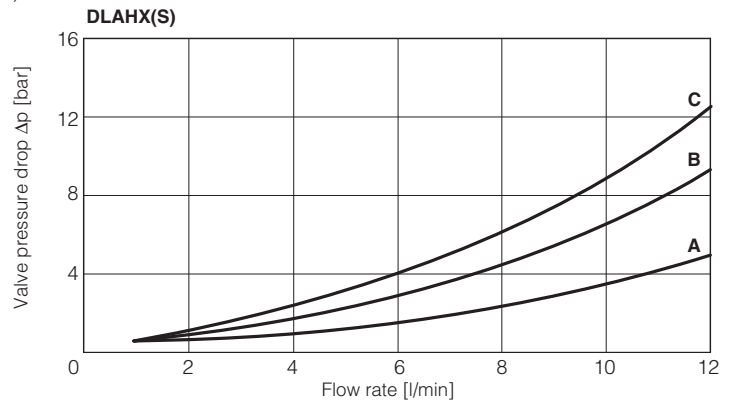

Valve type	Curve	Flow direction
DLAHMX(S)-3A	E	P-A, P-B
	D	A-T, B-T
DLAHMX(S)-3C	E	P-A, P-B
	D	A-T, B-T

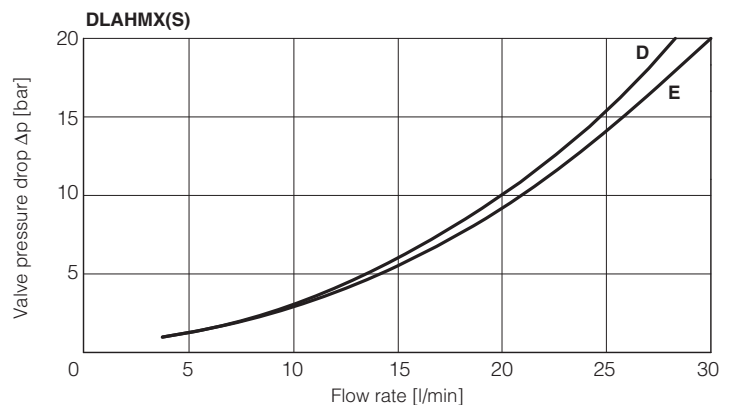

15 OPERATING LIMITS (based on mineral oil ISO VG 46 at 50°C)

The diagram have been obtained with warm solenoids and power supply at lowest value ($V_{nom} - 10\%$).

Valve type	Curve	Configuration
DLAHX4	A	3C
	B	3A

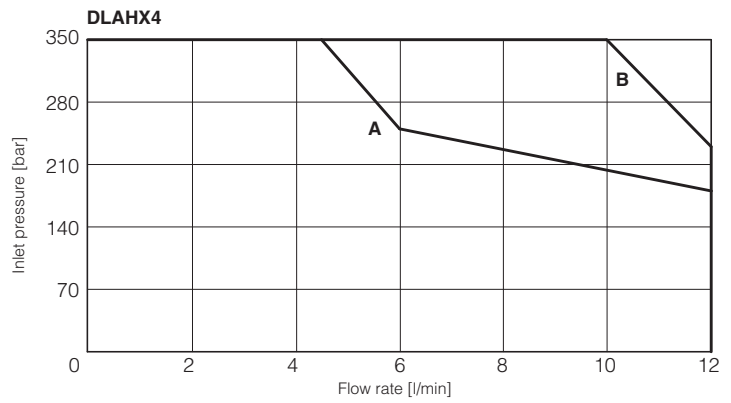

Valve type	Curve	Configuration
DLAHXS4	C	3A , 3C

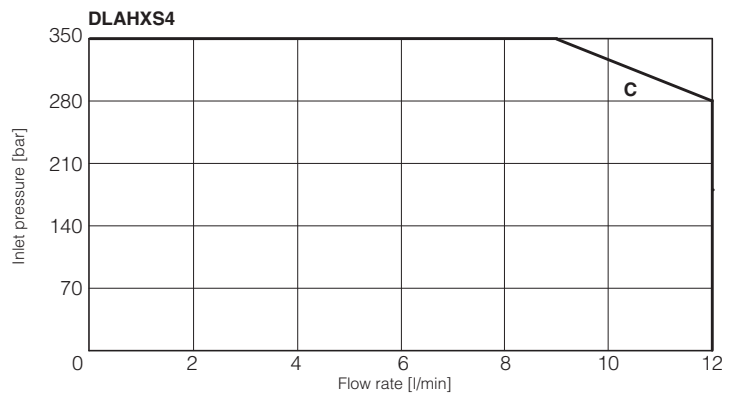

Valve type	Curve	Configuration
DLAHX6	D	3A
	E	3C

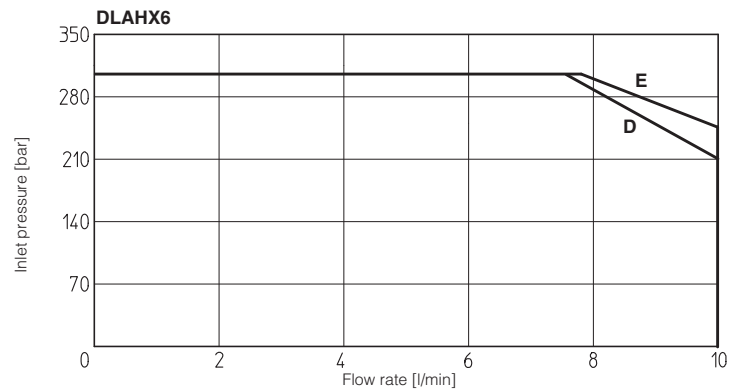

Valve type	Curve	Configuration
DLAHXS6	F	3A
	G	3C

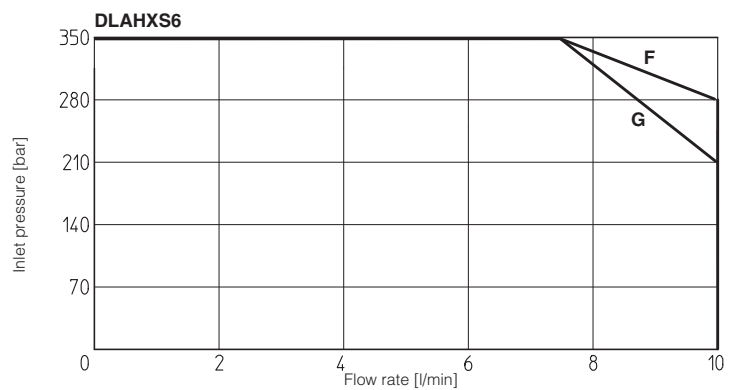

Valve type	Curve	Configuration
DLAHMX4	H	3C
	I	3A

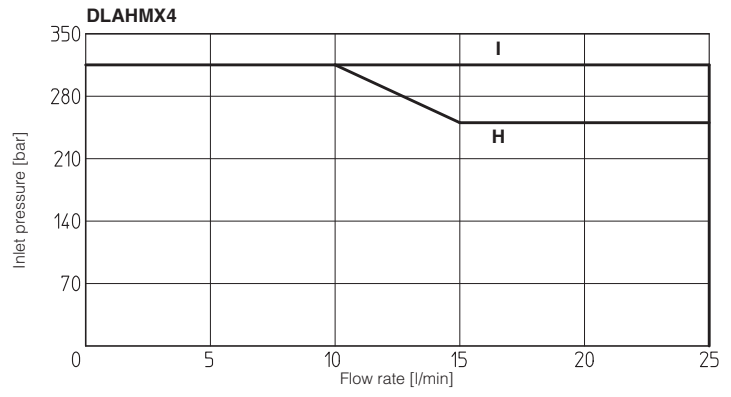

Valve type	Curve	Configuration
DLAHMXS4	L	3A
	M	3C

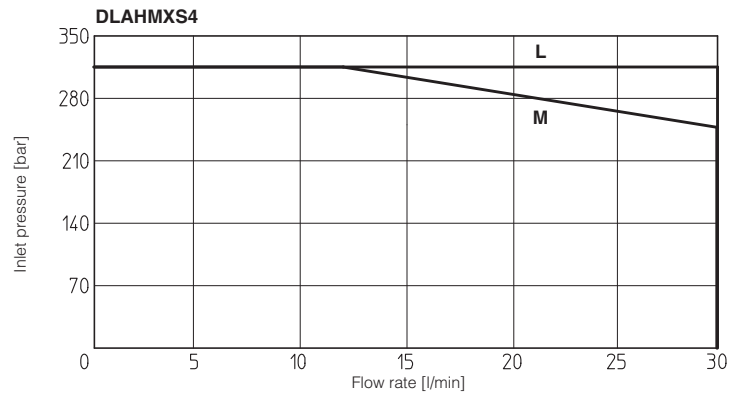

Valve type	Curve	Configuration
DLAHMXS6	N	3A , 3C

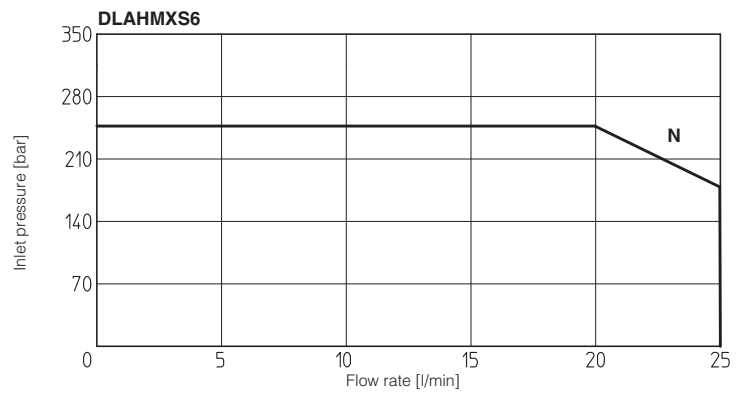

16 FASTENING BOLTS AND SEALS

	<p>Fastening bolts: 4 socket head screws M5x50-A4-70 Tightening torque = 5,5 Nm</p>		<p>Seals: 4 OR 108; Diameter of ports P, A, B, T: $\varnothing 7,5$ mm (max)</p>
--	--	--	--

17 INSTALLATION DIMENSIONS [mm]

ISO 4401: 2005
Mounting surface: 4401-03-02-0-05

Mass [kg]	
DLAHX(S)*-3A/M/V	3
DLAHX(S)*-3C/M	2,9
DLAHMX(S)*-3A/M/R	3,8
DLAHMX(S)*-3C/M	2,9
Option /O	+0,35

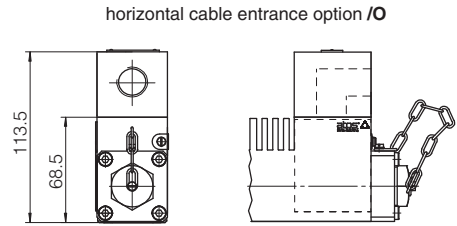
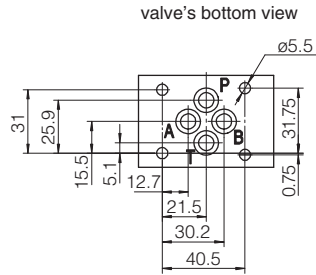

- P = PRESSURE PORT
- A = USE PORT (not used for -3C version)
- B = USE PORT (not used for -3A version)
- T = TANK PORT

DLAHX(S)*-3A/M/V

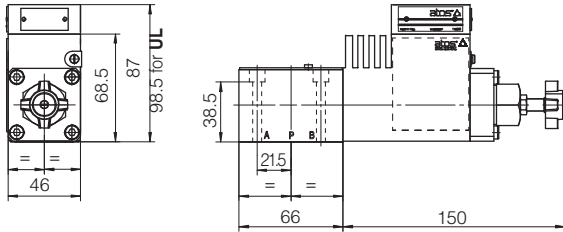

DLAHX(S)*-3C/M

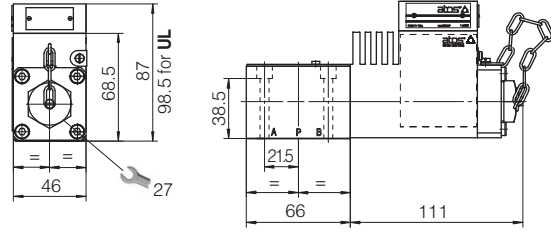

DLAHMX(S)*-3A/M/R

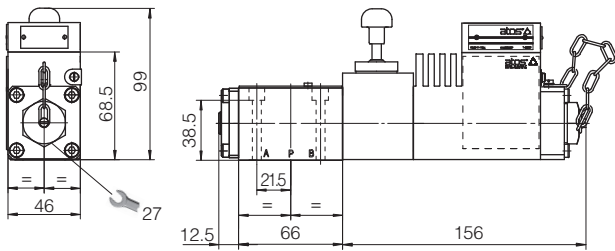

DLAHMX(S)*-3C/M

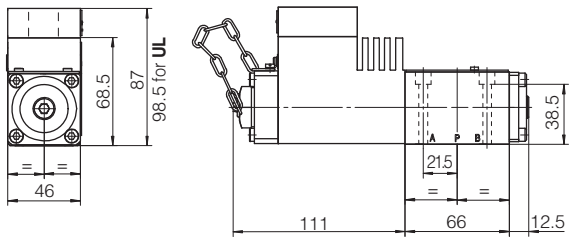

18 RELATED DOCUMENTATION

W010	Basics for electrohydraulics in corrosive environments	X010	Basics for electrohydraulics in hazardous environments
W020	Summary of Atos stainless steel components	KX800	Cable glands for ex-proof valves
EW900	Operating and maintenance information for stainless steel on-off valves		

Stainless steel ex-proof solenoid directional valves

on-off, piloted, poppet type leak free - ATEX, IECEx, EAC, PESO or cULus

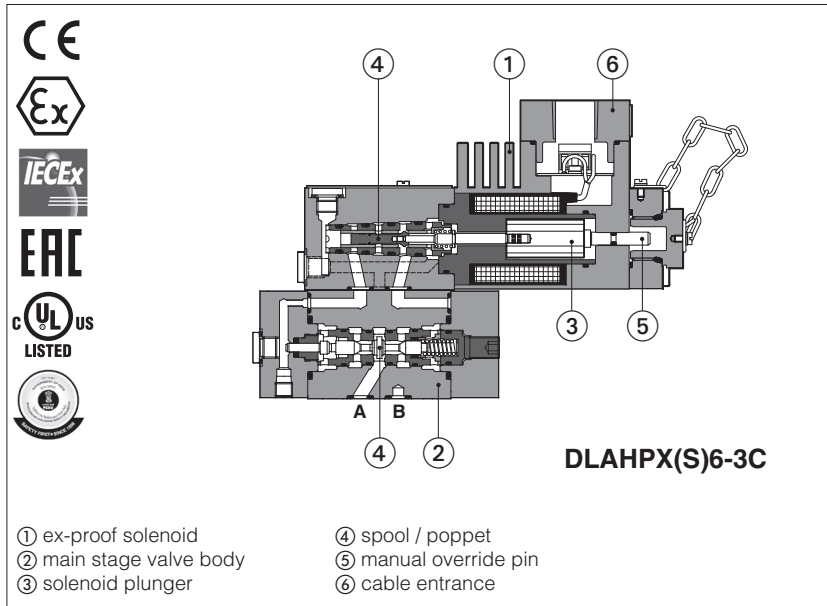

DLAHPX, DLAHPXS DLAPX, DLAPXS

Ex-proof, poppet type, piloted solenoid valves made in two different stainless steel executions for corrosive environments and fluids.

- X** full stainless steel for external and internal parts, to withstand extreme and corrosive environmental conditions, and to ensure full compatibility also with water base and special fluids.
- XS** stainless steel only for external parts to withstand extreme and corrosive environmental conditions.

Ex-proof stainless steel solenoids are provided with **ATEX, IECEx, EAC, PESO Multicertification** or **cULus** North American certification, see section 8.

DLAHPX(S):	DLAPX(S):
Size: 06 - ISO 4401 3/2 way Max flow: 40 l/min Max pressure: 315 bar	Size: 16 - not ISO 3/2 way Max flow: 220 l/min Max pressure: 315 bar

1 MODEL CODE

DLAHP	X	6	/	*	-	3	/	A	/	M	/	V	24DC	*	/	*	/	*
Ex-proof solenoid directional valve, leak free DLAHP = ISO size 06 max flow 40 l/min DLAP = size 16 not ISO max flow 220 l/min Stainless steel executions (1) X = full stainless steel XS = stainless steel only external parts Solenoid power and Temperature class , see also certification data in section 8: Multicertification 6 = 8W, class T6/T4 cULus 6 = 12W, class T6/T5 Certification type: - = omit for Multicertification (Group II) /UL = cULus certification 3 = three way Valve configuration - see section 2: A = A to T in rest position C = P to A in rest position																		Test fluid , only for X execution (2): H = mineral oil W = pure water Seals material , see section 6: - = NBR low temp. -40°C PE = FKM BBT = FVMQ fluorosilicon -60°C (3) Series number
Options - see section 12 for possible combined options: D = internal drain - only for DLAPX(S) E = external pilot pressure - only for DLAPX(S) O = horizontal cable entrance R = solenoid manual reset (not combinable with V) V = handwheel manual override (not combinable with R)													Solenoid threaded connection for cable gland fitting: M = M20x1,5 UNI-4535 (6H/6g) for Multicertification NPT = 1/2" NPT ANSI/ASME B46.1 (tapered) for /UL					

(1) See section 6 for materials specification.

(2) The "X" valves in full stainless steel execution are factory tested by Atos with mineral oil or pure water in order to avoid the contamination of the end user system. At the end of each valve model code must be specified the type of fluid to be used in the valve's testing: "H" for hydraulic oil or "W" for pure water.

(3) Only for Multicertified valves in full stainless steel "X" execution (not available for valves with UL certification)

1.1 Summary of available models

Valve execution		Multicertification		cULus		Max flow (l/min)	Max pressure (bar)
X	XS	Tclass	Power	Tclass	Power		
DLAHPX6	DLAHPXS6	T6, T4	8W	T6, T5	12W	40	315
DLAPX6	DLAPXS6	T6, T4	8W	T6, T5	12W	220	

2 CONFIGURATIONS AND HYDRAULIC SYMBOLS (representation according to ISO 1219-1)

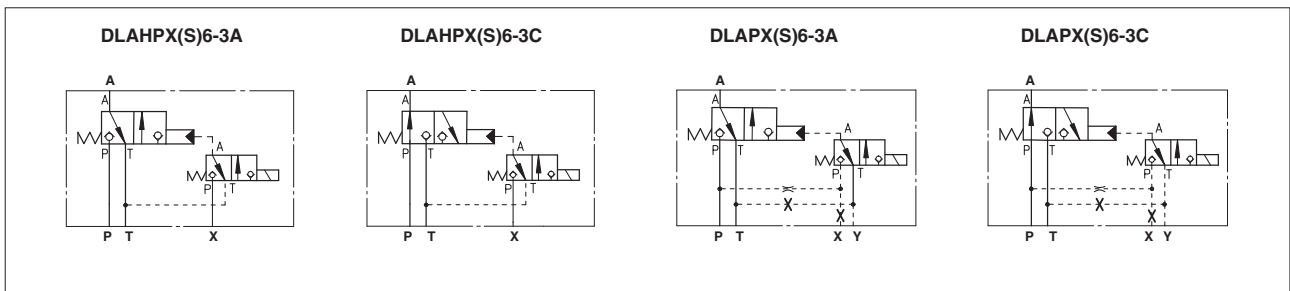

3 GENERAL CHARACTERISTICS

Assembly position / location	Any position
Subplate surface finishing	Roughness index Ra 0,4 - flatness ratio 0,01/100 (ISO 1101)
MTTFd values according to EN ISO 13849	75 years; for further details see technical table P007
Ambient temperature	Standard = -40°C ÷ +70°C /PE option = -20°C ÷ +70°C /BBT option = -60°C ÷ +70°C
Storage temperature range	Standard = -40°C ÷ +80°C /PE option = -20°C ÷ +80°C /BBT option = -60°C ÷ +80°C
Compliance	Explosion proof protection, see section 8 -Flame proof enclosure "Ex d" -Dust ignition protection by enclosure "Ex t" RoHs Directive 2011/65/EU as last update by 2015/65/EU REACH Regulation (EC) n°1907/2006

4 HYDRAULIC CHARACTERISTICS

Valve type	DLAHPX6 DLAHPXS6	DLAPX6 DLAPXS6
Valve size	06	not ISO standard
Max operating pressure:	ports P, A, B [bar]: 315 port T [bar]: 110	315
Pilot pressure:	Max [bar]: 315 Min [bar]: 90	315 see diagram at section 14
Max flow [l/min]	40	220
Internal leakage [cm³/min]	less than 5 drops/min (0,36 cm³/min) at max pressure	

⚠ For DLAHPX(S) and for DLAPX(S) with internal drain (option /D) the pressure at T port makes difficult the manual override operation that can be possible only if its value is lower than 50 bar

5 ELECTRICAL CHARACTERISTICS

Valve type	DLAHPX6 DLAHPXS6	DLAPX6 DLAPXS6	DLAHPX6/UL DLAHPXS6/UL	DLAPX6/UL DLAPXS6/UL
Voltage code (1) VDC ±10%	12DC, 24DC, 48DC, 110DC, 125DC, 220DC		12DC, 24DC, 110DC, 125DC, 220DC	
VAC 50/60 Hz ±10%	12AC, 24AC, 110AC, 230AC		12AC, 24AC, 110AC, 230AC	
Power consumption at 20°C	8W		12W	
Coil insulation	class H			
Protection degree with relevant cable gland	IP66/67 to DIN EN60529		raintight enclosure, UL approved	
Duty factor	100%			

(1) For alternating current supply a rectifier bridge is provided built-in the solenoid.
For power supply frequency 60 Hz, the nominal supply voltage of solenoids 110AC and 230AC must be 115/60 and 240/60 respectively

6 MATERIALS SPECIFICATION

Valve type	Solenoid housing	Valve body	Internal parts	Spring	Seals		
					std	/PE	/BBT
DLAHPX	AISI 630	AISI 630	AISI 316L, 420B, 440C, 430F	AISI 302	NBR 70 Sh low temp	FKM (viton)	FVMQ (fluorosilicon)
DLAHPXS	AISI 630	AISI 630	Carbon steel	AISI 302	NBR 70 Sh low temp	FKM (viton)	-
DLAPX	AISI 630	AISI 630	AISI 316L, 420B, 440C, 430F	AISI 302	NBR 70 Sh low temp	FKM (viton)	FVMQ (fluorosilicon)
DLAPXS	AISI 630	AISI 630	Carbon steel	AISI 302	NBR 70 Sh low temp	FKM (viton)	-

7 SEALS AND HYDRAULIC FLUIDS - for other fluids not included in below table, consult our technical office

Seals, recommended fluid temperature (1)	NBR seals (standard) = -40°C ÷ +60°C FKM seals (/PE option) = -20°C ÷ +80°C FVMQ seals (/BBT option) = -60°C ÷ +60°C		
Recommended viscosity	15÷100 mm ² /s - max allowed range 2.8 ÷ 500 mm ² /s min = 0,9 mm ² /s for X full stainless steel execution with pure water		
Max fluid contamination level	ISO4406 class 20/18/15 NAS1638 class 9, see also filter section at www.atos.com or KTF catalog		
Hydraulic fluid	Suitable seals type	Classification	Ref. Standard
Mineral oils	NBR low temp., FKM, FVMQ	HL, HLP, HLPD, HVLP, HVLPD	DIN 51524
Flame resistant without water	FKM, FVMQ	HFDU, HFDR	ISO 12922
Flame resistant with water (2)	NBR low temp.	HFA-E, HFA-S, HFB, HFC	

(1) The operating temperature of the fluid must be compatible with the maximum viscosity range allowed for the valve

(2) Performance limitations in case of flame resistant fluids with water:
-max operating pressure = 210 bar -max fluid temperature = 50°C

 The ignition temperature of the hydraulic fluid must be 50°C higher than the max solenoid surface temperature

8 CERTIFICATION DATA

8.1 Certification data for ambient temperature range -40 ÷ +70°C

Valve type	DLAHPX6, DLAHPXS6 DLAPX6, DLAPXS6		DLAHPX6/ UL , DLAHPXS6/ UL DLAPX6/ UL , DLAPXS6/ UL	
Certifications	Multicertification ATEX IECEx EAC		North American cULus	
Solenoid certified code	OAX/WP OAXS/WP		OAX/EC/WP OAXS/EC/WP	
Temperature class	T6	T4	T6	T5
Surface temperature	≤ 85 °C	≤ 135 °C	≤ 85 °C	≤ 100 °C
Ambient temperature (2)	-40 ÷ +45 °C	-40 ÷ +70 °C	-40 ÷ +55 °C	-40 ÷ +70 °C

8.2 Certification data for ambient temperature range -60 ÷ +70°C (valves with option /BBT)

Valve type	DLAHPX6, DLAPX6	
Certifications	Multicertification ATEX IECEx EAC PESO	
Solenoid certified code	OABX/WP	
Temperature class	T6	T4
Surface temperature	≤ 85 °C	≤ 135 °C
Ambient temperature (2)	-60 ÷ +45 °C	-60 ÷ +70 °C

8.3 Certificates and applicable standards

Certifications	Multicertification Group II ATEX IECEx EAC PESO		North American cULus
Type examination certificate (1)	ATEX: CESI 02 ATEX 014 IECEX: IECEx CES 10.0010x EAC: TC RU C-IT. 08.B.01784 PESO: P391133/1		20170324 - E366100
Method of protection	<ul style="list-style-type: none"> • ATEX, EAC Ex II 2G Ex d IIC T6/T4/T3 Gb Ex II 2D Ex tb IIIC T85°C/T200°C Db • IECEx Ex db IIC T6/T4/T3 Gb Ex tb IIIC T85°C/T200°C Db • PESO Ex II 2G Exd IIC T6/T4/T3 Gb 		<ul style="list-style-type: none"> • UL 1203 Class I, Div.I, Groups C & D Class I, Zone I, Groups IIA & IIB
Applicable standards	EN 60079-0 EN 60079-1 EN 60079-31	IEC 60079-0 IEC 60079-1 IEC 60079-31	UL 1203 and UL429, CSA 22.2 n°30-1986 CSA 22.2 n°139-13
Cable entrance:	M20x1,5		1/2" NPT ANSI/ASME B46.1

(1) The type examiner certificates can be downloaded from www.atos.com

 **WARNING: service work performed on the valve by the end users or not qualified personnel invalidates the certification**

9 EX PROOF SOLENOIDS WIRING

Multicertification

Standard version Option /O

① cover with threaded connection for vertical cable gland fitting
 ② cover with threaded connection for horizontal cable gland fitting
 ③ terminal board for cables wiring
 ④ standard manual override protected by cap
 ⑤ screw terminal for additional equipotential grounding

<p>1 = Coil 2 = GND 3 = Coil</p>	<p>PCB 3 poles terminal board suitable for wires cross sections up to 2,5 mm² (max AWG14)</p>
--	--

cULus certification

Standard version Option /O

① cover with threaded connection for vertical cable gland fitting
 ② cover with threaded connection for horizontal cable gland fitting
 ③ terminal board for cables wiring
 ④ standard manual override protected by cap

⚠ Pay attention to respect the polarity

1 = Coil + PCB 3 poles terminal board suggested cable section up to 1,5 mm²
 2 = GND
 3 = Coil - (max AWG16), see section 10 note 1

alternative GND screw terminal connected to solenoid housing

10 CABLE SPECIFICATION AND TEMPERATURE - Power supply and grounding cables have to comply with following characteristics:

<p>Multicertification</p> <p>Power supply: section of coil connection wires = 2,5 mm²</p>	<p>Grounding: section of internal ground wire = 2,5 mm² section of external ground wire = 4 mm²</p>
<p>cULus certification:</p> <ul style="list-style-type: none"> • Suitable for use in Class I Division 1, Gas Groups C • Armored Marine Shipboard Cable which meets UL 1309 • Tinned Stranded Copper Conductors • Bronze braided armor • Overall impervious sheath over the armor <p>Any Listed (UBVZ/UBVZ7) Marine Shipboard Cable rated 300 V min, 15A min. 3C 2,5 mm² (14 AWG) having a suitable service temperature range of at least -40°C to +110°C</p> <p>Note 1: For Class I wiring the 3C 1,5 mm² AWG 16 cable size is admitted only if a fuse lower than 10 A is connected to the load side of the solenoid wiring.</p>	

10.1 Cable temperature

The cable must be suitable for the working temperature as specified in the "safety instructions" delivered with the first supply of the products.

Multicertification

Solenoid code	Max ambient temperature [°C]	Temperature class	Max surface temperature [°C]	Min cable temperature
OA(B)X	45 °C	T6	85 °C	not prescribed
OA(B)XS	70 °C	T4	135 °C	90 °C

cULus certification

Solenoid code	Max ambient temperature [°C]	Temperature class	Max surface temperature [°C]	Min cable temperature
OAX/EC	55 °C	T6	85 °C	100 °C
OAXS/EC	70 °C	T5	100 °C	100 °C

11 CABLE GLANDS - only **Multicertification**

Cable glands with threaded connections M20x1,5 for standard or armoured cables have to be ordered separately, see tech. table **KX800**

Note: a Loctite sealant type 545, should be used on the cable gland entry threads

12 OPTIONS

- O** = horizontal cable entrance , to be selected in case of limited vertical space
R = solenoid manual reset (not combinable with /V)
V = with handwheel manual override (not combinable with /R)

Only for DLAPX(S)

D = internal drain

E = external pilot pressure

12.1 Possible combined options

DLAHPX(S): OR, OV

DLAPX(S): DE, DO, DR, DV, EO, ER, EV, OR, OV, DEO, DER, DEV, DOR, DOV, EOR, EOVS

13 Q/Δp DIAGRAMS (based on mineral oil ISO VG 46 at 50°C)

Valve type	Curve	Flow direction
DLAHPX	A	P-A, P-B
DLAHPXS	B	A-T, B-T

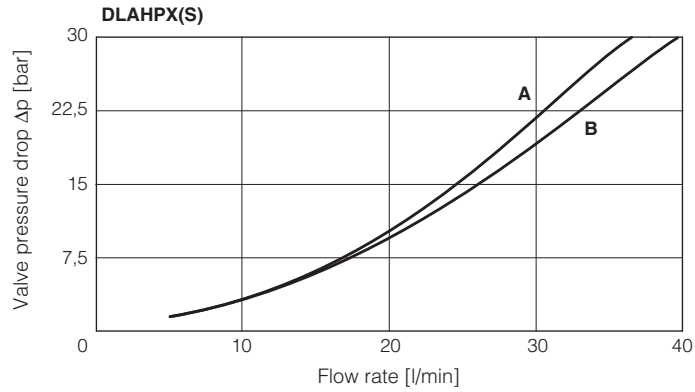

Valve type	Curve	Flow direction
DLAPX	A	A-T
DLAPXS	B	P-A

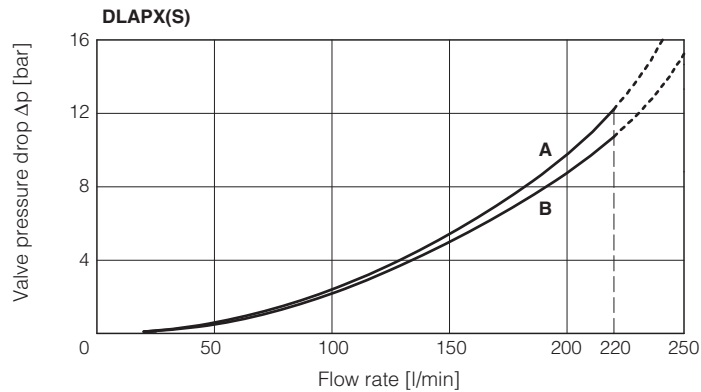

14 MINIMUM PILOT PRESSURE FOR DLAPX(S)

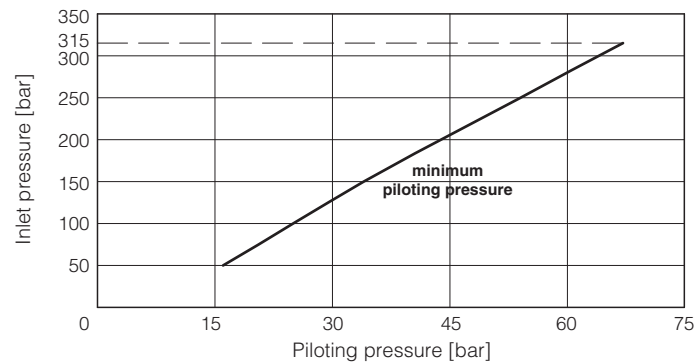

15 FASTENING BOLTS AND SEALS

Type	Size	Fastening bolts	Seals
DLAHPX(S)	06	4 socket head screws M5x75-A4-70 Tightening torque = 5,5 Nm	4 OR 108 Diameter of ports P, A, B, T: Ø 7,5 mm (max)
DLAPX(S)	no ISO standards	4 socket head screws M10x70-A4-70 Tightening torque = 40 Nm	3 OR 3081 Diameter of ports P, A, T: Ø 16 mm (max) 2 OR 108 Diameter of ports X, Y: Ø 7 mm (max)

16 INSTALLATION DIMENSIONS OF DLAHPX(S) [mm]

ISO 4401: 2005
Mounting surface: 4401-03-02-0-05

Mass [kg]	
DLAHPX(S)-3A	7,8
DLAHPX(S)-3C	7,5
Option /O	+0,35
Option /V	+0,35

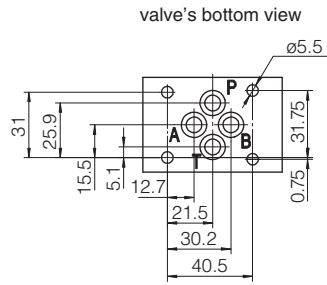

- P** = PRESSURE PORT
- A** = USE PORT
- B** = not used
- T** = TANK PORT
- X** = PILOT PORT

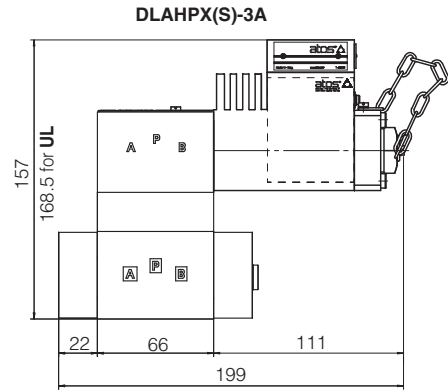
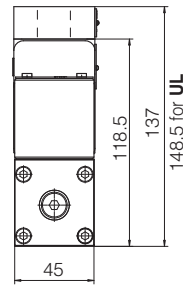
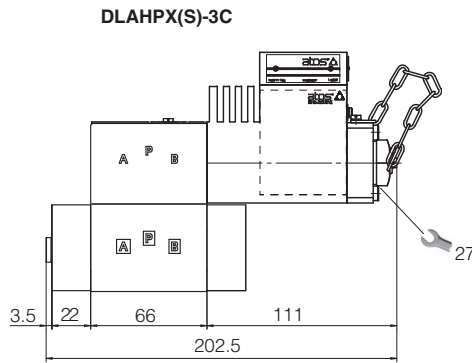

17 INSTALLATION DIMENSIONS OF DLAPX(S) [mm]

Mounting surface not ISO standard

Mass [kg]	
DLAPX(S)6-3A	8,5
DLAPX(S)6-3C	8,5
Option /O	+0,35
Option /V	+0,35

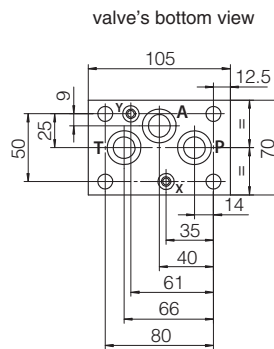

- P** = PRESSURE PORT
- A** = USE PORT
- T** = TANK PORT
- X** = PILOT PORT
- Y** = DRAIN PORT

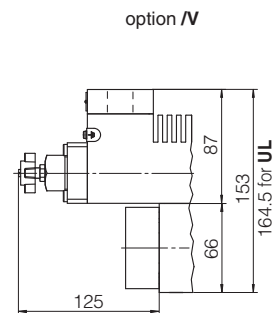
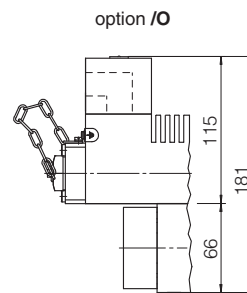
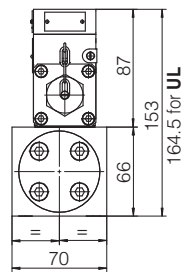
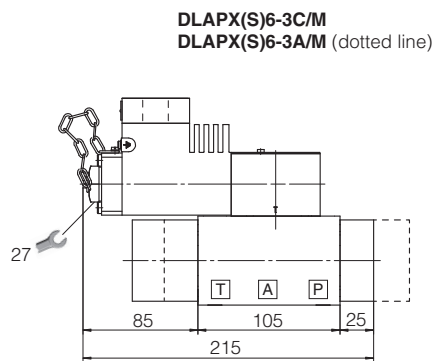

18 RELATED DOCUMENTATION

- W010** Basics for electrohydraulics in corrosive environments
- W020** Summary of Atos stainless steel components
- EW900** Operating and maintenance information for stainless steel on-off valves

- X010** Basics for electrohydraulics in hazardous environments
- KX800** Cable glands for ex-proof valves

Stainless steel hydraulic operated directional valves

on-off, poppet type leak free

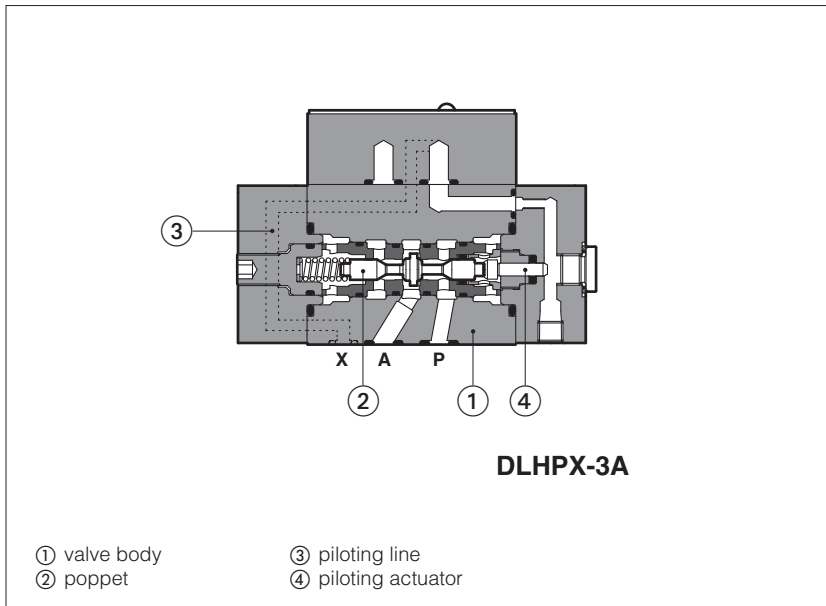

DLHPX, DLHPXS DLPX, DLPXS

Poppet type, hydraulic operated directional valves made in two different stainless steel executions for corrosive environments:

- **X** stainless steel for external and internal parts, to withstand extreme and corrosive environmental conditions, and to ensure full compatibility also with water base and special fluids.
- **XS** stainless steel for external parts to withstand extreme and corrosive environmental conditions.

DLPX and DLPXS are **SIL** compliance with IEC 61508 (TÜV certified)

DLHPX(S):

Size: **06** - ISO 4401
3/2 way
Max flow: **40 l/min**
Max pressure: **315 bar**

DLPX(S):

Size: **16** - not ISO
3/2 way
Max flow: **220 l/min**
Max pressure: **315 bar**

1 MODEL CODE

DLHP	X	-	3	A	*	/	*	/	*
<p>Hydraulic operated directional valves</p> <p>DLHP = ISO size 06, max flow 40 l/min</p> <p>DLP = Size 16 not ISO, max flow 220 l/min</p> <p>Stainless steel executions (1):</p> <p>X = full stainless steel</p> <p>XS = stainless steel only external parts</p> <p>3 = three way</p> <p>Valve configuration - see section 2:</p> <p>A = A to T in rest position</p> <p>C = P to A in rest position</p>									<p>Test fluid, only for X execution (2):</p> <p>H = mineral oil</p> <p>W = pure water</p> <p>Seals material, see section 5:</p> <p>- = NBR low temp. -40°C</p> <p>PE = FKM</p> <p>BBT = FVMQ fluorosilicon -60°C (3)</p>
									Series number

(1) See section 5 for materials specifications:

(2) The "X" valves in full stainless steel execution are factory tested by Atos with mineral oil or pure water in order to avoid the contamination of the end user system. At the end of each valve model code must be specified the type of fluid to be used in the valve's testing: "H" for hydraulic oil or "W" for pure water.

(3) Only for full stainless steel "X" execution

2 CONFIGURATIONS AND HYDRAULIC SYMBOLS (representation according to ISO 1219-1)

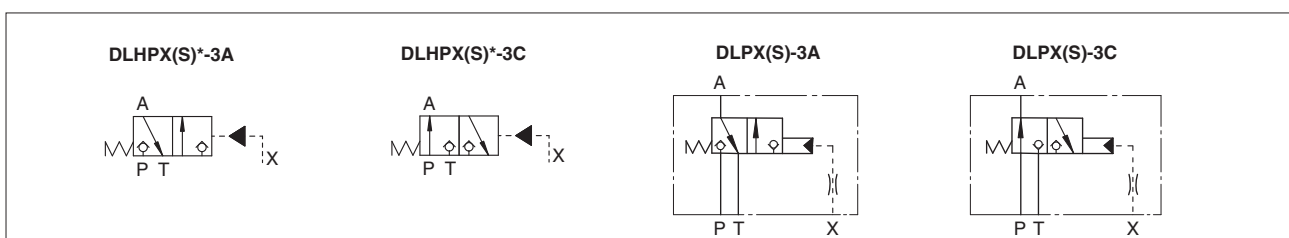

3 GENERAL CHARACTERISTICS

Assembly position / location	Any position
Subplate surface finishing	Roughness index Ra 0,4 - flatness ratio 0,01/100 (ISO 1101)
MTTFd values according to EN ISO 13849	150 years for direct operated; for further details see technical table P007
Ambient temperature	Standard = -40°C ÷ +70°C /PE option = -20°C ÷ +70°C /BBT option = -60°C ÷ +70°C
Storage temperature range	Standard = -40°C ÷ +80°C /PE option = -20°C ÷ +80°C /BBT option = -60°C ÷ +80°C
Compliance	SIL to IEC 61508: 2010, see section [7] (only for DLPX and DLPXS) RoHs Directive 2011/65/EU as last update by 2015/65/EU REACH Regulation (EC) n°1907/2006

4 HYDRAULIC CHARACTERISTICS

Valve type	DLHPX DLHPXS	DLPX DLPXS
Valve size	06	not ISO standard
Max operating pressure:	315	
ports P, A, X [bar]	110	
port T [bar]		
Pilot pressure	315	
max [bar]	315	315
min [bar]	90	see diagram at section [9]
Max flow [l/min]	40	220
Internal leakage [cm³/min]	Less than 5 drops/min (0,36 cm³/min) at max pressure	

5 MATERIALS SPECIFICATION

Valve code	Solenoid housing	Valve body	Internal parts	Spring	Seals		
					std	/PE	/BBT
DLHPX	AISI 630	AISI 630	AISI 316L, 420B, 440C, 430F	AISI 302	NBR 70 Sh low temp	FKM (viton)	FMVQ (fluorosilicon)
DLHPXS	AISI 630	AISI 630	Carbon steel	AISI 302	NBR 70 Sh low temp	FKM (viton)	-
DLPX	AISI 630	AISI 630	AISI 316L, 420B, 440C, 430F	AISI 302	NBR 70 Sh low temp	FKM (viton)	FMVQ (fluorosilicon)
DLPXS	AISI 630	AISI 630	Carbon steel	AISI 302	NBR 70 Sh low temp	FKM (viton)	-

6 SEALS AND HYDRAULIC FLUIDS - for other fluids not included in below table, consult our technical office

Seals, recommended fluid temperature (1)	NBR seals (standard) = -40°C ÷ +60°C FKM seals (/PE option) = -20°C ÷ +80°C FVMQ seals (/BBT option) = -60°C ÷ +60°C		
Recommended viscosity	15 ÷ 100 mm²/s - max allowed range 2.8 ÷ 500 mm²/s min = 0,9 mm²/s for X full stainless steel execution with pure water		
Max fluid contamination level	ISO4406 class 20/18/15 NAS1638 class 9, see also filter section at www.atos.com or KTF catalog		
Hydraulic fluid	Suitable seals type	Classification	Ref. Standard
Mineral oils	NBR low temp., FKM, FVMQ	HL, HLP, HLPD, HVLP, HVLPD	DIN 51524
Flame resistant without water	FKM, FVMQ	HFDU, HFDR	ISO 12922
Flame resistant with water (2)	NBR low temp.	HFA-E, HFA-S, HFB, HFC	

(1) The operating temperature of the fluid must be compatible with the maximum viscosity range allowed for the valve

(2) **Performance limitations in case of flame resistant fluids with water:**

-max operating pressure = 210 bar -max fluid temperature = 50°C

⚠ The ignition temperature of the hydraulic fluid must be 50°C higher than the max solenoid surface temperature

7 SIL compliance with IEC 61508: 2010 - only DLPX and DLPXS

DLPX and DLPXS meet the requirements of:

- **SC3** (systematic capability)
- max **SIL 3** (HFT = 1 if the hydraulic system provides the redundancy for the specific safety function where the component is applied)

8 Q/Δp DIAGRAMS (based on mineral oil ISO VG 46 at 50°C)

Valve type	Curve	Flow direction
DLHPX	A	P-A, P-B
DLHPXS	B	A-T, B-T

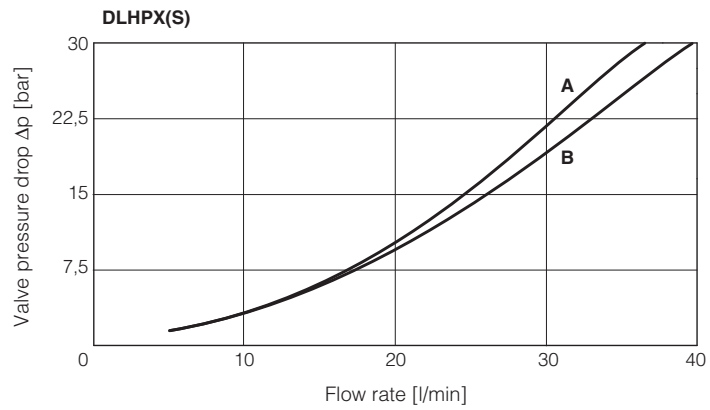

Valve type	Curve	Flow direction
DLPX	A	A-T
DLPXS	B	P-A

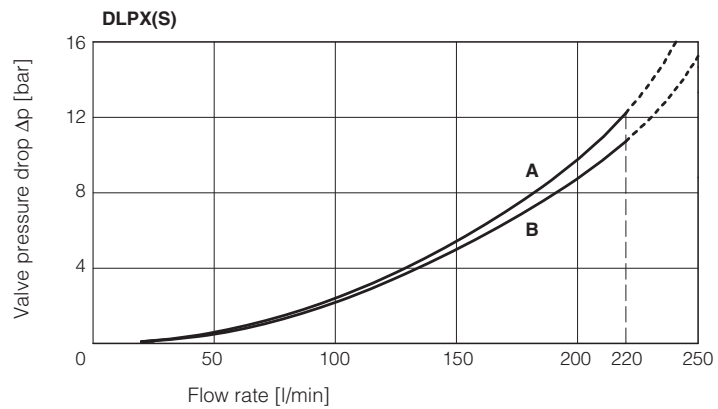

9 MINIMUM PILOT PRESSURE FOR DLPX(S)

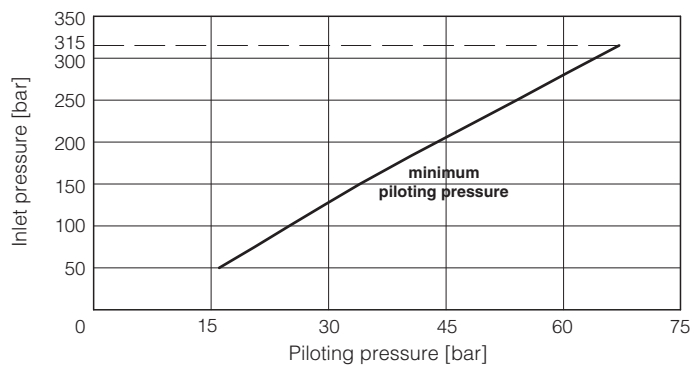

10 FASTENING BOLTS AND SEALS

Type	Size	Fastening bolts	Seals
DLHPX(S)	06	4 socket head screws M5x75-A4-70 Tightening torque = 5,5 Nm	4 OR 108; Diameter of ports P, A, B, T: Ø 7,5 mm (max)
DLPX(S)	no ISO standards	4 socket head screws M10x70-A4-70 Tightening torque = 40 Nm	3 OR 3081; Diameter of ports P, A, T: Ø 16 mm (max) 2 OR 108; Diameter of ports X, Y: Ø 7 mm (max)

11 INSTALLATION DIMENSIONS OF DLHPX(S) [mm]

ISO 4401: 2005
Mounting surface: 4401-03-02-0-05

Mass [kg]	
DLHPX(S)	5

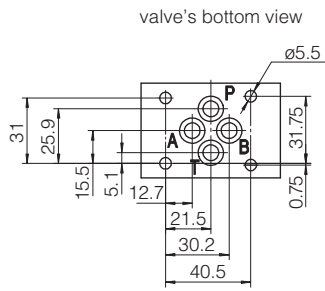

- P** = PRESSURE PORT
- A** = USE PORT
- B** = not present
- T** = TANK PORT
- X** = PILOT PORT

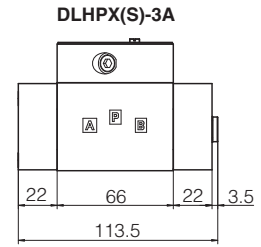
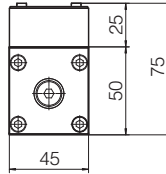
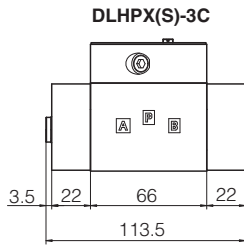

12 INSTALLATION DIMENSIONS OF DLPX(S) [mm]

Mounting surface not ISO standard

Mass [kg]	
DLPX(S)	6

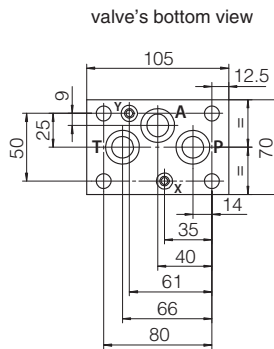

- P** = PRESSURE PORT
- A** = USE POR
- T** = TANK PORT
- X** = PILOT PORT
- Y** = DRAIN PORT

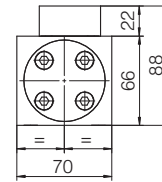
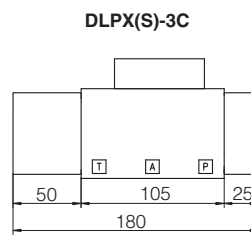
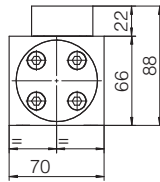
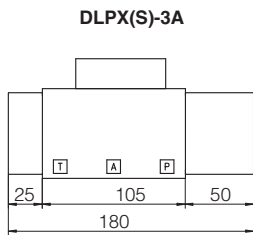

13 RELATED DOCUMENTATION

- W010** Basics for electrohydraulics in corrosive environments
- W020** Summary of Atos stainless steel components
- EW900** Operating and maintenance information for stainless steel on-off valves

Stainless steel pressure relief valves

direct, screw-in cartridges

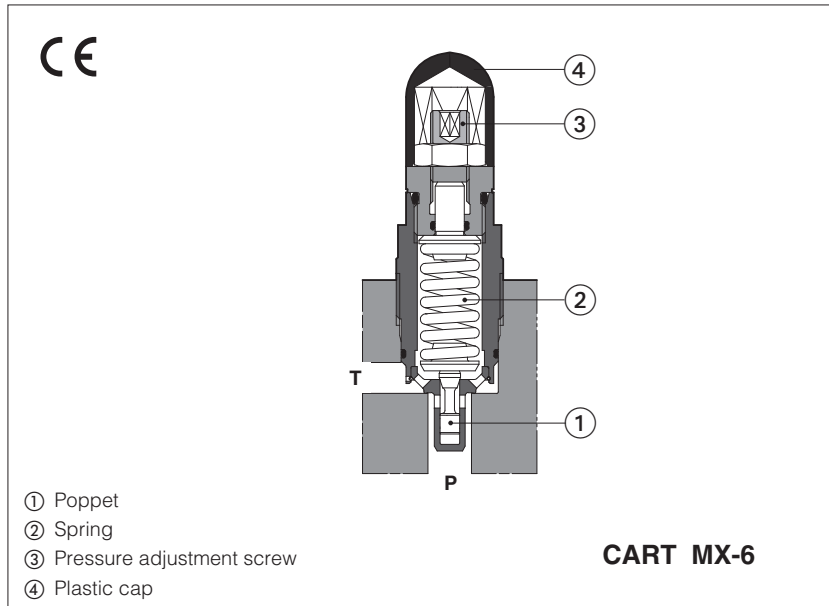

CART-MX(S), CART-AREX(S)

Screw-in, direct operated pressure relief valves used to limit the max pressure in the hydraulic systems or to protect part of the circuit from overpressure.

The cartridge design reduces the dimension of blocks and manifolds, without penalizing the functional characteristics.

They are available in three sizes and in two different stainless steel executions for corrosive environments and fluids.

- **X** full stainless steel for external and internal parts, to withstand extreme and corrosive environmental conditions, and to ensure full compatibility also with water base and special fluids.
- **XS** stainless steel only for external parts to withstand extreme and corrosive environmental conditions.

Size: **G1/2" ÷ M35**

Max flow: **2,5 ÷ 120 l/min**

Max pressure: up to **420 bar**

1 MODEL CODE OF SCREW-IN VALVES

CART	AREX-20	/	350	/	R	/	*	/	*	/	*
Screw-in pressure relief cartridge							Series number				Test fluid , only for X execution: (3) H = mineral oil W = pure water Seals material , see section [5] : - = NBR low temp. -40°C PE = FKM BBT = FVMQ fluorosilicon -60°C (4)
Size and stainless steel execution (1) : MX-3, MXS-3 = G1/2" MX-6, MXS-6 = M33x1,5 AREX-20, AREXS-20 = M35x1,5											
Max pressure settings: see hydraulic characteristics in section [4]						R = reduced leakage for special applications only for CART AREX-20 and CART AREXS-20 (2)					

For **PED** safety version see technical table CWY010

- (1) X** = Full stainless steel
XS = Stainless steel only for external parts

See section **[5]** for material specification

(2) Code **R** must be always reported in the model code of CART AREX-20 and CART AREXS-20

(3) CART MX and CART AREX in full stainless steel execution are factory tested with mineral oil or pure water in order to avoid the contamination of the end user system. At the end of each valve model code must be specified the type of fluid to be used in the valve's testing: "**H**" for hydraulic oil or "**W**" for pure water.

(4) Only for full stainless steel "**X**" execution

2 HYDRAULIC SYMBOLS

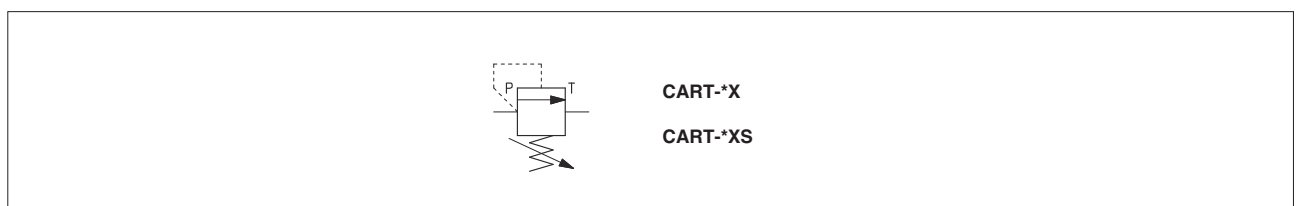

3 GENERAL CHARACTERISTICS

Assembly position / location	Any position
Cavity	See section 8
MTTFd values according to EN ISO 13849	150 years, for further details see technical table P007
Ambient temperature	Standard = -40°C ÷ +70°C /PE option = -20°C ÷ +70°C /BBT option = -60°C ÷ +70°C
Storage temperature range	Standard = -20°C ÷ +80°C /PE option = -20°C ÷ +80°C /BBT option = -60°C ÷ +80°C
Compliance	RoHS Directive 2011/65/EU as last update by 2015/65/EU REACH Regulation (EC) n°1907/2006

4 HYDRAULICS CHARACTERISTICS

Valve model		CART MX-3 CART MXS-3	CART MX-6 CART MXS-6	CART AREX-20 CART AREXS-20
Max pressure setting [bar]		50, 100, 210, 350, 420	50, 100, 210, 350, 420	50, 100, 210, 315, 400
Pressure range (1) [bar]		4÷50, 6÷100, 7÷210, 8÷350, 15÷420	2÷50, 3÷100, 8÷210, 15÷350, 15÷420	3÷50, 5÷100, 6÷210, 8÷315, 10÷400
Max flow [l/min]		2,5	40	120

(1) The values correspond to the min and max regulation of the valve's craking pressure

5 MATERIALS SPECIFICATION

Valve code	Valve type	Valve body	Internal parts	Spring	Seals		
					std	/PE	/BBT
CART-*X	Screw-in	AISI 316L	AISI 316L, 420B, 440C	AISI 302	NBR 70 Sh low temp	FKM (viton)	FMVQ (fluorosilicon)
CART-*XS	Screw-in	AISI 316L	Carbon steel	AISI 302	NBR 70 Sh low temp	FKM (viton)	-

6 SEALS AND HYDRAULIC FLUIDS - for other fluids not included in below table, consult our technical office

Seals, recommended fluid temperature (1)	NBR seals (standard) = -40°C ÷ +60°C FKM seals (/PE option) = -20°C ÷ +80°C FVMQ seals (/BBT option) = -60°C ÷ +60°C		
Recommended viscosity	15÷100 mm ² /s - max allowed range 2.8 ÷ 500 mm ² /s min = 0,9 mm ² /s for X full stainless steel execution with pure water		
Max fluid contamination level	ISO4406 class 20/18/15 NAS1638 class 9, see also filter section at www.atos.com or KTF catalog		
Hydraulic fluid	Suitable seals type	Classification	Ref. Standard
Mineral oils	NBR low temp., FKM, FVMQ	HL, HLP, HLPD, HVLP, HVLDP	DIN 51524
Flame resistant without water	FKM, FVMQ	HFDU, HFDR	ISO 12922
Flame resistant with water	NBR low temp.	HFA-E, HFA-S, HFB, HFC	

(1) The operating temperature of the fluid must be compatible with the maximum viscosity range allowed for the valve

7 REGULATED PRESSURE VS FLOW DIAGRAMS (based on mineral oil ISO VG 46 at 50°C)

CART MX(S)-3

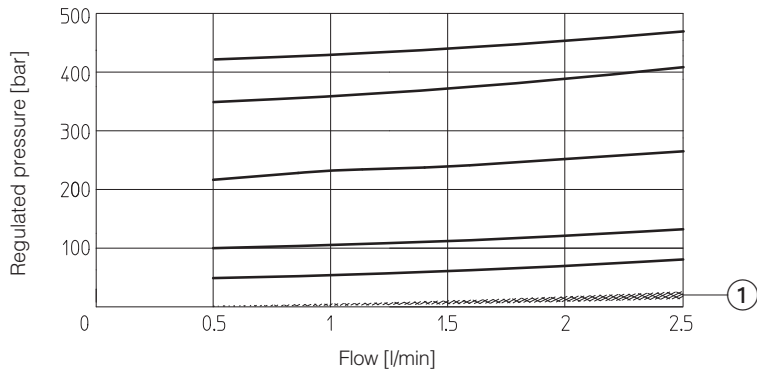

CART MX(S)-6

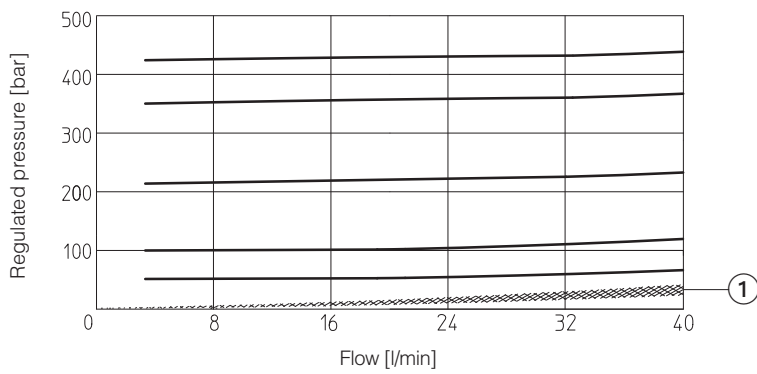

CART AREX(S)-20 **/R

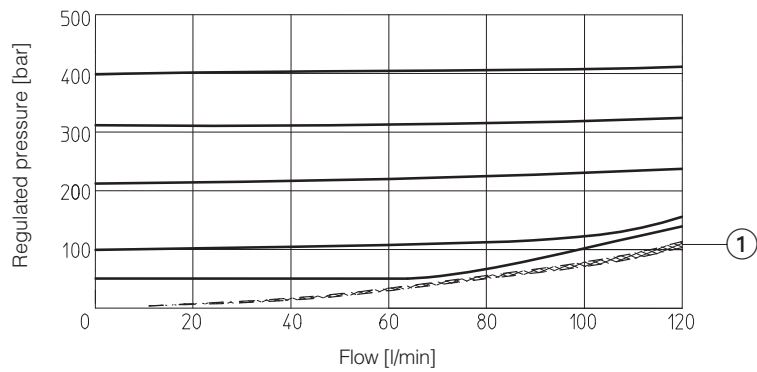

① Minimum pressure with the adjustment screw fully unscrewed

Stainless steel pressure relief valves

direct, modular

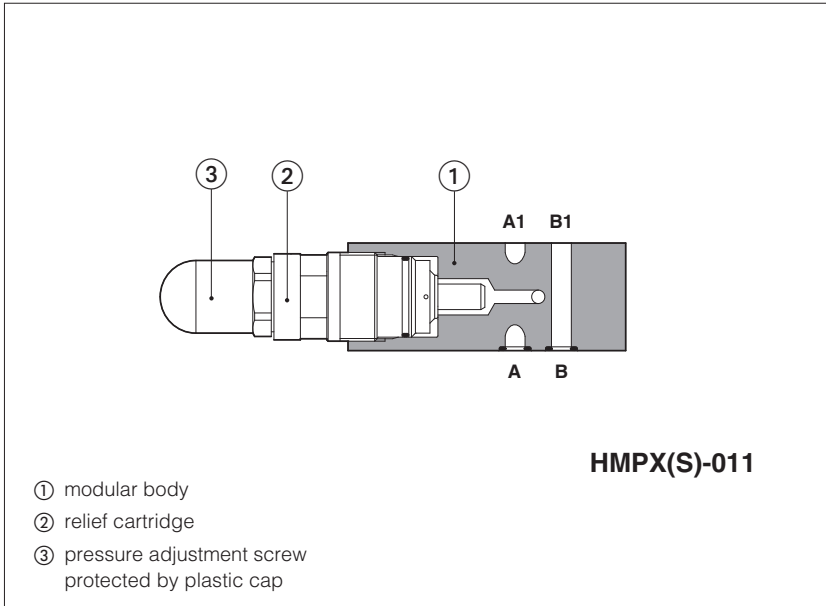

HMPX, HMPXS

Pressure relief valves made in modular execution for stack mounting with stainless steel directional valves ISO size 06. They are made in two different stainless steel executions for corrosive environments and fluids:

- **X** stainless steel for external and internal parts, to withstand extreme and corrosive environmental conditions, and to ensure full compatibility also with water base and special fluids.
- **XS** stainless steel for external parts to withstand extreme and corrosive environmental conditions.

Size: **06** - ISO 4401

Max flow: up to **35 l/min**

Max pressure: up to **350 bar**

1 MODEL CODE OF MODULR VALVES

HMP	X	-	011	/	350	/	**	/	*	/	*
Modular pressure relief valve ISO 4401 size 06							Series number				Test fluid, only for X execution: H = mineral oil W = pure water
X = Stainless steel execution for all parts XS = Stainless steel execution for external parts							Seals material, see section [4]: - = NBR low temp. -40°C PE = FKM BBT = FVMQ fluorosilicon -60°C (1)				
Configuration, see section [2] 011 013 014					Pressure range: 50 = 50 bar 100 = 100 bar				210 = 210 bar 350 = 350 bar		

(1) Only for full stainless steel "X" execution

2 HYDRAULIC SYMBOLS

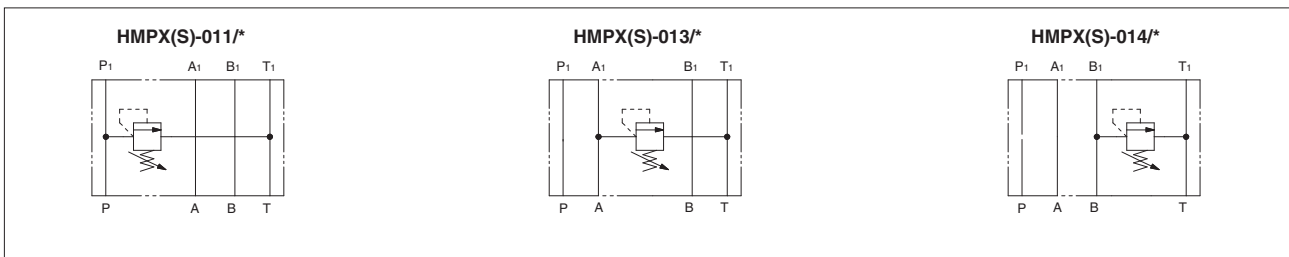

3 GENERAL CHARACTERISTICS

Assembly position / location	Any position
Subplate surface finishing	Roughness index Ra 0,4 - flatness ratio 0,01/100 (ISO 1101)
MTTFd values according to EN ISO 13849	150 years, for further details see technical table P007
Ambient temperature	Standard = -40°C ÷ +70°C /PE option = -20°C ÷ +70°C /BBT option = -60°C ÷ +70°C
Storage temperature range	Standard = -40°C ÷ +80°C /PE option = -20°C ÷ +80°C /BBT option = -60°C ÷ +80°C
Compliance	RoHs Directive 2011/65/EU as last update by 2015/65/EU REACH Regulation (EC) n°1907/2006

4 MATERIALS SPECIFICATION

Valve code	Valve type	Valve body	Internal parts	Spring	Seals		
					std	/PE	/BBT
HMPX	Modular	AISI 316L	AISI 316L, 420B, 630	AISI 302	NBR 70 Sh low temp	FKM (viton)	FVMQ (fluorosilicon)
HMPXS	Modular	AISI 316L	Carbon steel	AISI 302	NBR 70 Sh low temp	FKM (viton)	-

5 SEALS AND HYDRAULIC FLUIDS - for other fluids not included in below table, consult our technical office

Seals, recommended fluid temperature (1)	NBR seals (standard) = -40°C ÷ +60°C FKM seals (/PE option) = -20°C ÷ +80°C FVMQ seals (/BBT option) = -60°C ÷ +60°C		
Recommended viscosity	115÷100 mm ² /s - max allowed range 2.8 ÷ 500 mm ² /s min = 0,9 mm ² /s for X full stainless steel execution with pure water		
Max fluid contamination level	ISO4406 class 20/18/15 NAS1638 class 9, see also filter section at www.atos.com or KTF catalog		
Hydraulic fluid	Suitable seals type	Classification	Ref. Standard
Mineral oils	NBR low temp., FKM, FVMQ	HL, HLP, HLPD, HVL, HVLDP	DIN 51524
Flame resistant without water	FKM, FVMQ	HFDR, HFDR	ISO 12922
Flame resistant with water	NBR low temp.	HFA-E, HFA-S, HFB, HFC	

(1) The operating temperature of the fluid must be compatible with the maximum viscosity range allowed for the valve

6 HYDRAULICS CHARACTERISTICS

Valve model	HMPX HMPXS	
Max pressure [bar]	Ports P, A, B = 350; Port T = 50	
Max pressure setting [bar]	50, 100, 210, 350	
Pressure range (1) [bar]	2÷50, 3÷100, 10÷210, 15÷350	
Max flow [l/min]	35	

(1) The values correspond to the min and max regulation of the valve's craking pressure

7 DIAGRAMS (based on mineral oil ISO VG 46 at 50°C)

7.1 Regulated pressure versus flow diagram

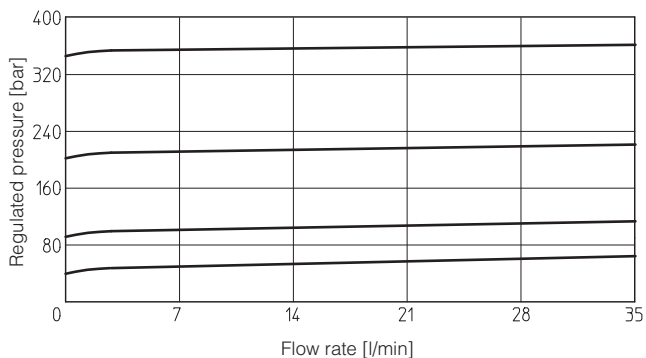

7.2 Minimum pressure versus flow diagram

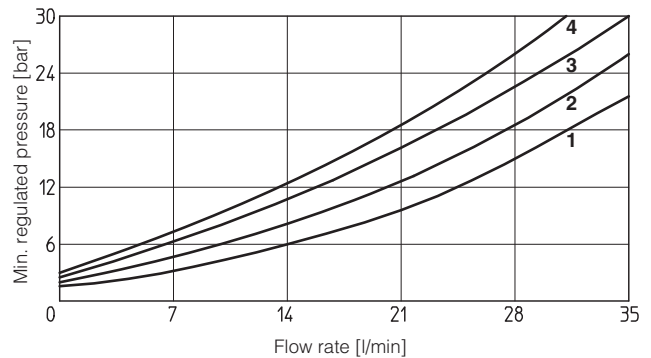

1 = HMPX(S)-*/50
2 = HMPX(S)-*/100

3 = HMPX(S)-*/210
4 = HMPX(S)-*/350

8 FASTENING BOLTS AND SEALS

Type	Size	Fastening bolts	Seals
HMPX	06 (ISO 4401)	n°4 M5xL-A4-70 Tightening torque = 5,5Nm	n°4 OR-108
HMPXS	06 (ISO 4401)	n°4 M5xL-A4-70 Tightening torque = 5,5Nm	n°4 OR-108

9 INSTALLATION DIMENSIONS OF MODULAR VALVES

ISO 4401: 2005

Mounting surface: 4401-03-02-0-05

Fastening bolts: M5x**-A4-70

Tightening torque = 5,5 Nm

Seals: 4 OR 108

Ports P,A,B,T: $\varnothing = 7.5$ mm (max)

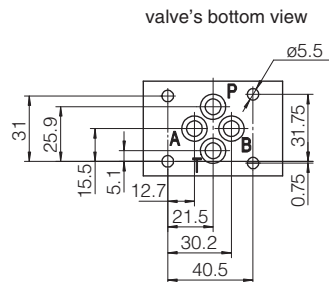

P = PRESSURE PORT
A, B = USE PORT
T = TANK PORT

HMPX(S)-011/*

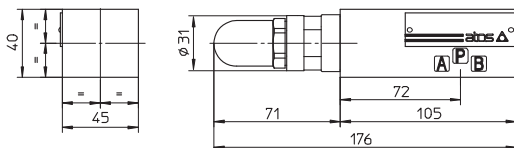

Mass [kg] 1,4

HMPX(S)-013/*

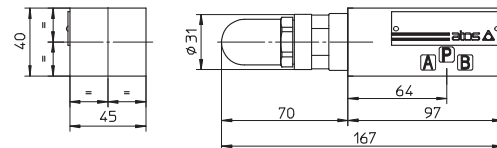

Mass [kg] 1,2

HMPX(S)-014/*

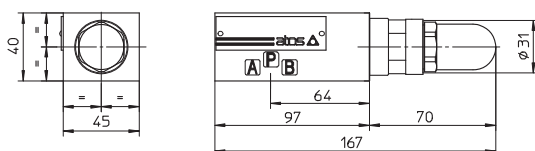

Mass [kg] 1,2

Pressure adjustment screw

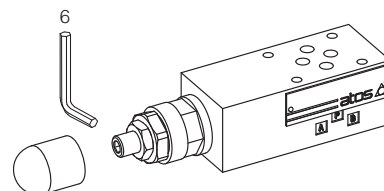

10 RELATED DOCUMENTATION

W010	Basics for electrohydraulics in corrosive environments
W020	Summary of Atos stainless steel components
EW900	Operating and maintenance information for stainless steel on-off valves

Stainless steel safety pressure relief valves

direct, screw-in cartridges, conforming to PED Directive 2014/68/EU - certified by 

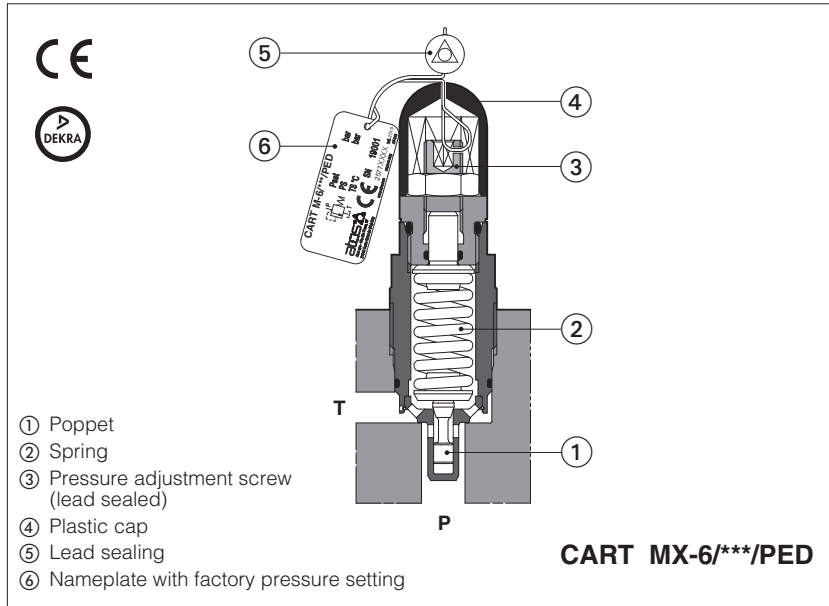

CART /PED

Safety pressure relief valves, certified by DEKRA according to Pressure Equipment Directive 2014/68/EU (PED).

They are designed to operate as safety components, limiting the maximum system pressure or to protect parts of the hydraulic circuit and accumulators from overpressure. The valves are made in two different stainless steel executions for corrosive environments and fluids:

- X** full stainless steel for external and internal parts, to withstand extreme and corrosive environmental conditions, and to ensure full compatibility also with water base and special fluids.
- XS** stainless steel only for external parts to withstand extreme and corrosive environmental conditions.

Size: **G1/2" ÷ M35**
 Max flow: **2,5 ÷ 150 l/min**
 Max pressure: up to **420 bar**

1 MODEL CODE

CART	MX-3	/	420	/	PED	/	*	/	*	/	*	/	*
Screw-in pressure relief cartridge									Series number				Test fluid, only for X execution: (2) H = mineral oil W = pure water Seals material, see section 5: - = NBR low temperature PE = FKM
Size and stainless steel executions (1): MX-3, MXS-3 = G1/2" MX-6, MXS-6 = M33x1,5 AREX-20, AREXS-20 = M35x1,5													
Max pressure settings (bar): 420 = for CART MX(S)-3 and CART MX(S)-6 400 = for CART AREX(S)-20													
(1) X = Full stainless steel XS = Stainless steel only for external parts See section 5 for material specification													
(2) CART MX and CART AREX in full stainless steel execution are factory tested with mineral oil or pure water in order to avoid the contamination of the end user system. At the end of each valve model code must be specified the type of fluid to be used in the valve's testing: "H" for hydraulic oil or "W" for pure water.													

Pressure setting:
280 = factory preset regulation to be defined depending to the customer requirements (example 280 = 280 bar)
 min step: 1bar
 min pressure setting: 25/30 bar see section 4

PED = safety version certified by DEKRA according to 2014/68/EU

2 HYDRAULIC SYMBOL

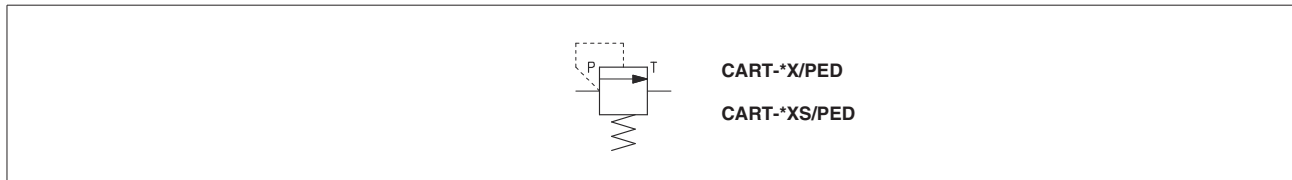

3 GENERAL CHARACTERISTICS

Assembly position / location	Any position
Cavity	See section 10
MTTFd values according to EN ISO 13849	150 years, for further details see technical table P007
Ambient temperature	Standard = -40°C ÷ +70°C /PE option = -20°C ÷ +70°C
Storage temperature range	Standard = -20°C ÷ +80°C /PE option = -20°C ÷ +80°C
Compliance	PED Directive 2014/68/EU - EU type-examination certificate (1) RoHS Directive 2011/65/EU as last update by 2015/65/EU REACH Regulation (EC) n°1907/2006

(1) The type-examination certificate can be download from www.atos.com

4 HYDRAULIC CHARACTERISTICS

Valve model	CART MX(S)-3 /PED	CART MX(S)-6 /PED	CART AREX(S)-20 /PED
Max pressure setting [bar]	420	420	400
Pressure range (1) [bar]	25 ÷ 420	25 ÷ 420	30 ÷ 400
Max flow [l/min]	2,5	60	150

(1) The values correspond to the min and max regulation of the valve's craking pressure

5 MATERIALS SPECIFICATION

Valve code	Valve type	Valve body	Internal parts	Spring	Seals	
					std	/PE
CART-*X	Screw-in	AISI 316L	AISI 316L, 420B, 440C	AISI 302	NBR 70 Sh low temp	FKM (viton)
CART-*XS	Screw-in	AISI 316L	Carbon steel	AISI 302	NBR 70 Sh low temp	FKM (viton)

6 SEALS AND HYDRAULIC FLUIDS - for other fluids not included in below table, consult our technical office

Seals, recommended fluid temperature (1)	NBR low temp. seals (standard) = -40°C ÷ +60°C FKM seals (/PE option) = -20°C ÷ +80°C		
Recommended viscosity	15 ÷ 100 mm ² /s - max allowed range 2.8 ÷ 500 mm ² /s min = 0,9 mm ² /s for X full stainless steel execution with pure water		
Max fluid contamination level	ISO4406 class 20/18/15 NAS1638 class 9, see also filter section at www.atos.com or KTF catalog		
Hydraulic fluid	Suitable seals type	Classification	Ref. Standard
Mineral oils	NBR low temp., FKM	HL, HLP, HLPD, HVL, HVLDP	DIN 51524
Flame resistant without water	FKM	HFDU, HFDR	ISO 12922
Flame resistant with water	NBR low temp.	HFA-E, HFA-S, HFB, HFC	

(1) The operating temperature of the fluid must be compatible with the maximum viscosity range allowed for the valve

7 FACTORY PRESSURE SETTING

The /PED valves are factory set at the pressure level required by the customer (min step: 1bar). The factory pressure setting is performed at the flow shown in the following table. The factory pressure setting is marked on the valve nameplate, see section 8

VALVE MODEL	FLOW FOR FACTORY PRESSURE SETTING (l/min)
CART MX-3 CART MXS-3	0.5
CART MX-6 CART MXS-6	2
CART AREX-20 CART AREXS-20	2

⚠ Any tampering of the lead sealing invalidates the certification

8 NAMEPLATE MARKING

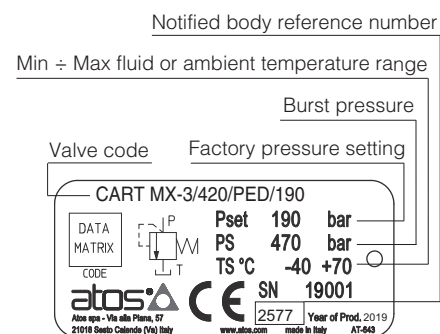

Note: **TS** values are referred to the extreme temperatures, regardless of whether the fluid or the ambient

9 PERMITTED WORKING RANGE (based on mineral oil ISO VG 46 at 50°C)

CART MX(S)-3 **/PED

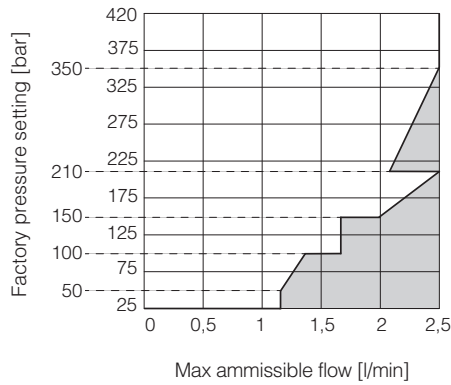

CART MX(S)-6 **/PED

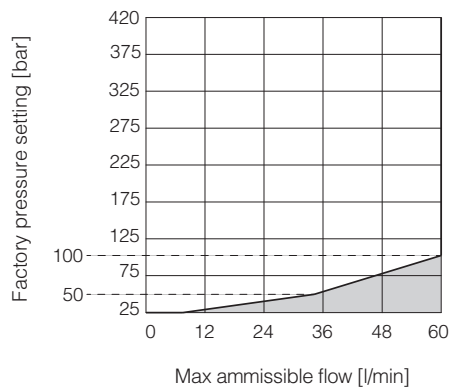

CART AREX(S)-20 **/PED

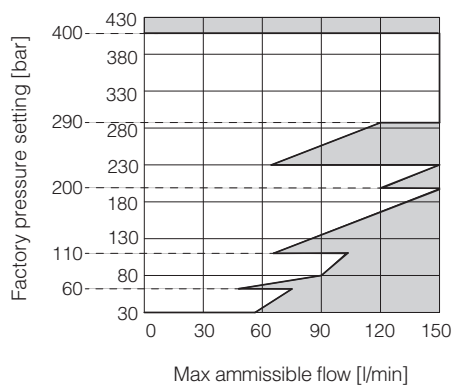

Notes:

1) The valves can operate only in the white area of the above diagrams.

The max ammissible flow values within the white area are those for which the pressure increase remains within **+10% with respect to the factory pressure setting**.

Pressure / flow values located in gray areas cannot be performed.

⚠ Before ordering the valve, check that the maximum ammissible flow at the required pressure setting, is greater than the maximum flow rate of the system or the accumulator to be protected.

2) The working range in above diagrams is valid without counterpressure in T line.

The factory pressure setting is increased by the counterpressure valve in T line.

As general rule PED valves should be operated without counter pressure in the T line.

In case of counter pressure in T line, the maximum ammissible flow has to be reduced with respect to the values reported in the diagram, so as not to exceed the limit of +10% with respect to the factory pressure setting. Contact Atos technical office for details.

Stainless steel pressure relief valves

ISO functional cover and 2-way slip-in cartridge

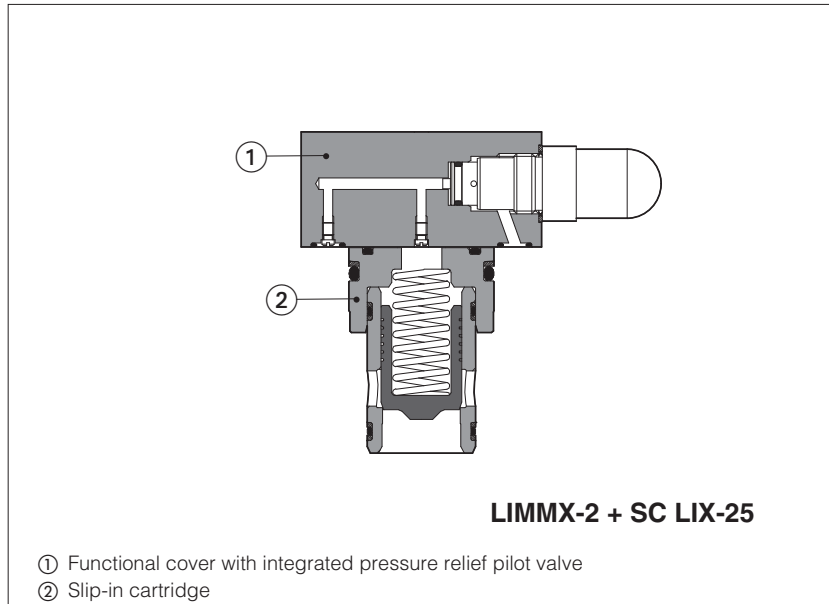

LIMMX, LIMMXS, SC LIX

Pressure relief valves, in cartridge design conforming to ISO7368 standard for installation in compact manifolds.

They are made by a functional cover **LIMMX(S)** and a 2-way slip-in cartridge **SC LIX**:

Functional covers are available in two different stainless steel executions for corrosive environments and fluids:

- **X** full stainless steel for external and internal parts, to withstand extreme and corrosive environmental conditions, and to ensure full compatibility also with water base and special fluids.
- **XS** stainless steel only for external parts to withstand extreme and corrosive environmental conditions.

LIMMXS cover can be used also with standard SC LI-25*, see tech. table H030

LIMMX + SC LIX

LIMMXS + SC LI:

Size: **25** - ISO 7368

Max flow: **370 l/min** at Δp 5 bar

Max pressure: **350 bar**

1 MODEL CODE OF FUNCTIONAL COVER and SLIP-IN CARTRIDGE VALVES

1.1 Model code of functional cover

LIMM	X	-	2	/	350	**	/	*	/	*
Cover according to ISO 7368						Series number				Test fluid, only for X execution: (3) H = mineral oil W = pure water
Stainless steel execution: (1) X = Full stainless steel XS = Stainless steel only external parts (2)								Seals material, see section [5] : - = NBR low temp. -40°C PE = FKM BBT = FVMQ fluorosilicon -60°C (4)		
Size: 2 = 25					Pressure range 50 = 6 ÷ 50 bar 210 = 10 ÷ 210 bar 100 = 8 ÷ 100 bar 350 = 15 ÷ 350 bar					

1.2 Model code of slip-in cartridge

SC LI	X	-	25	31	/	2	**	/	*	/	*
Cartridge according to ISO 7368							Series number				Test fluid: (3) H = mineral oil W = pure water
Stainless steel execution: X = Full stainless steel								Seals material, see section [5] : - = NBR low temp. -40°C PE = FKM BBT = FVMQ fluorosilicon -60°C			
Size 25						Spring cracking pressure 1 = 0,3 bar 3 = 3 bar 2 = 1,2 bar 6 = 6 bar					

(1) See section **[5]** for material specifications

(2) LIMMXS cover can be used with standard SCLI-25* cartridge

(3) LIMMX and SC LIX in full stainless steel execution are factory tested with mineral oil or pure water in order to avoid the contamination of the end user system. At the end of each valve model code must be specified the type of fluid to be used in the valve's testing: "H" for hydraulic oil or "W" for pure water.

(4) Only for full stainless steel "X" execution

2 HYDRAULIC SYMBOL

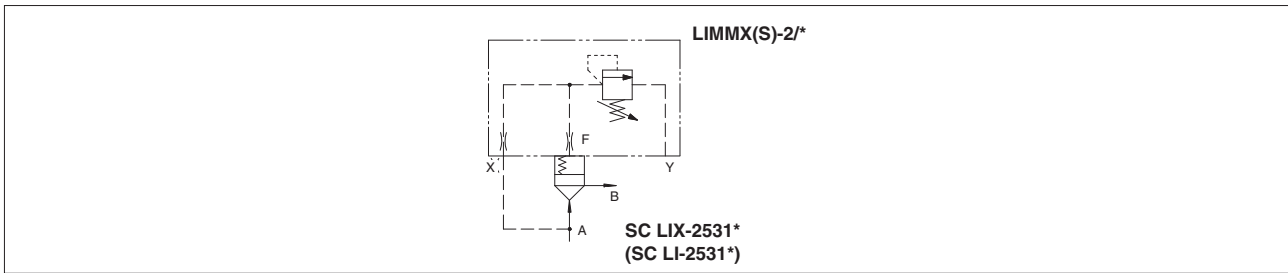

3 GENERAL CHARACTERISTICS

Assembly position / location	Any position
Mounting surface and cavity dimensions	ISO 7368, see section 9
MTTFd values according to EN ISO 13849	75 years, for further details see technical table P007
Ambient temperature	Standard = -40°C ÷ +70°C /PE option = -20°C ÷ +70°C /BBT option = -60°C ÷ +70°C
Storage temperature range	Standard = -40°C ÷ +80°C /PE option = -20°C ÷ +80°C /BBT option = -60°C ÷ +80°C
Compliance	RoHs Directive 2011/65/EU as last update by 2015/65/EU REACH Regulation (EC) n°1907/2006

4 HYDRAULICS CHARACTERISTICS

4.1 Hydraulic characteristics of LIMMX(S) functional cover

Functionl cover	LIMMX, LIMMXS
Opening pressure [bar]	Port X = 350; Port Y = 50

5.2 Hydraulic characteristics of SC LIX slip-in cartridge

Slip-in cartridge	SC LIX
Opening pressure [bar]	350
Nominal Flow at Δp 5 bar [l/min]	370
Type of poppet	31
Functional sketch (Hydraulic symbol)	
Typical section	
Area ratio A: AP	1:1

5 MATERIALS SPECIFICATION

Valve code	Valve type	Valve body	Internal parts	Spring	Seals		
					std	/PE	/BBT
LIMMX	Functional cover	AISI 316L	AISI 316L, 420B, 630	AISI 302	NBR 70 Sh low temp	FKM (viton)	FMVQ (fluorosilicon)
LIMMXS	Functional cover	AISI 316L	Carbon steel	AISI 302	NBR 70 Sh low temp	FKM (viton)	-
SC LIX	Cartridge	AISI 316L	AISI 316L, 420B, 630	AISI 302	NBR 70 Sh low temp	FKM (viton)	FMVQ (fluorosilicon)

6 SEALS AND HYDRAULIC FLUIDS - for other fluids not included in below table, consult our technical office

Seals, recommended fluid temperature (1)	NBR low temp. seals (standard) = -40°C ÷ +60°C FKM seals (/PE option) = -20°C ÷ +80°C FVMQ seals (/BBT option) = -60°C ÷ +60°C		
Recommended viscosity	15 ÷ 100 mm ² /s - max allowed range 2.8 ÷ 500 mm ² /s min = 0,9 mm ² /s for X full stainless steel execution with pure water		
Max fluid contamination level	ISO4406 class 20/18/15 NAS1638 class 9, see also filter section at www.atos.com or KTF catalog		
Hydraulic fluid	Suitable seals type	Classification	Ref. Standard
Mineral oils	NBR low temp., FKM, FVMQ	HL, HLP, HLPD, HVL, HVLDP	DIN 51524
Flame resistant without water	FKM, FVMQ	HFDU, HFDR	ISO 12922
Flame resistant with water	NBR low temp.	HFA-E, HFA-S, HFB, HFC	

(1) The operating temperature of the fluid must be compatible with the maximum viscosity range allowed for the valve

7 FLOW/ Δp DIAGRAM (based on mineral oil ISO VG 46 at 50°C)

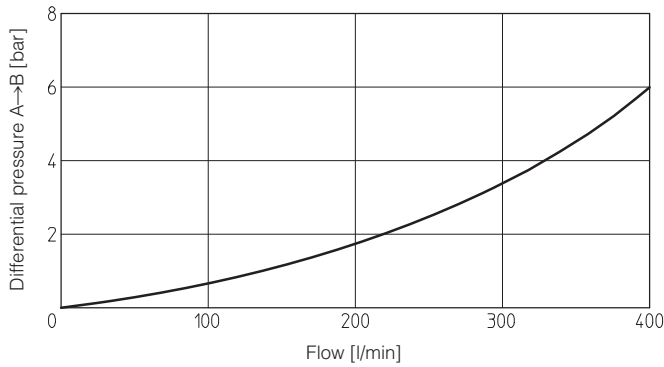

8 FASTENING BOLTS AND SEALS

Type	Size	Fastening bolts	Seals
LIMMX LIMMXS	25 (ISO 7368)	n°4 M12x45-A4-70 Tightening torque = 125Nm	n°2 OR-108
SC LIX	25 (ISO 7368)	-	n°1 OR-3100 n°1 OR-4150, n°2 4150.BURC-39.20 n°1 OR-2118, n°2 2118.BURC-31.20

9 INSTALLATION DIMENSIONS

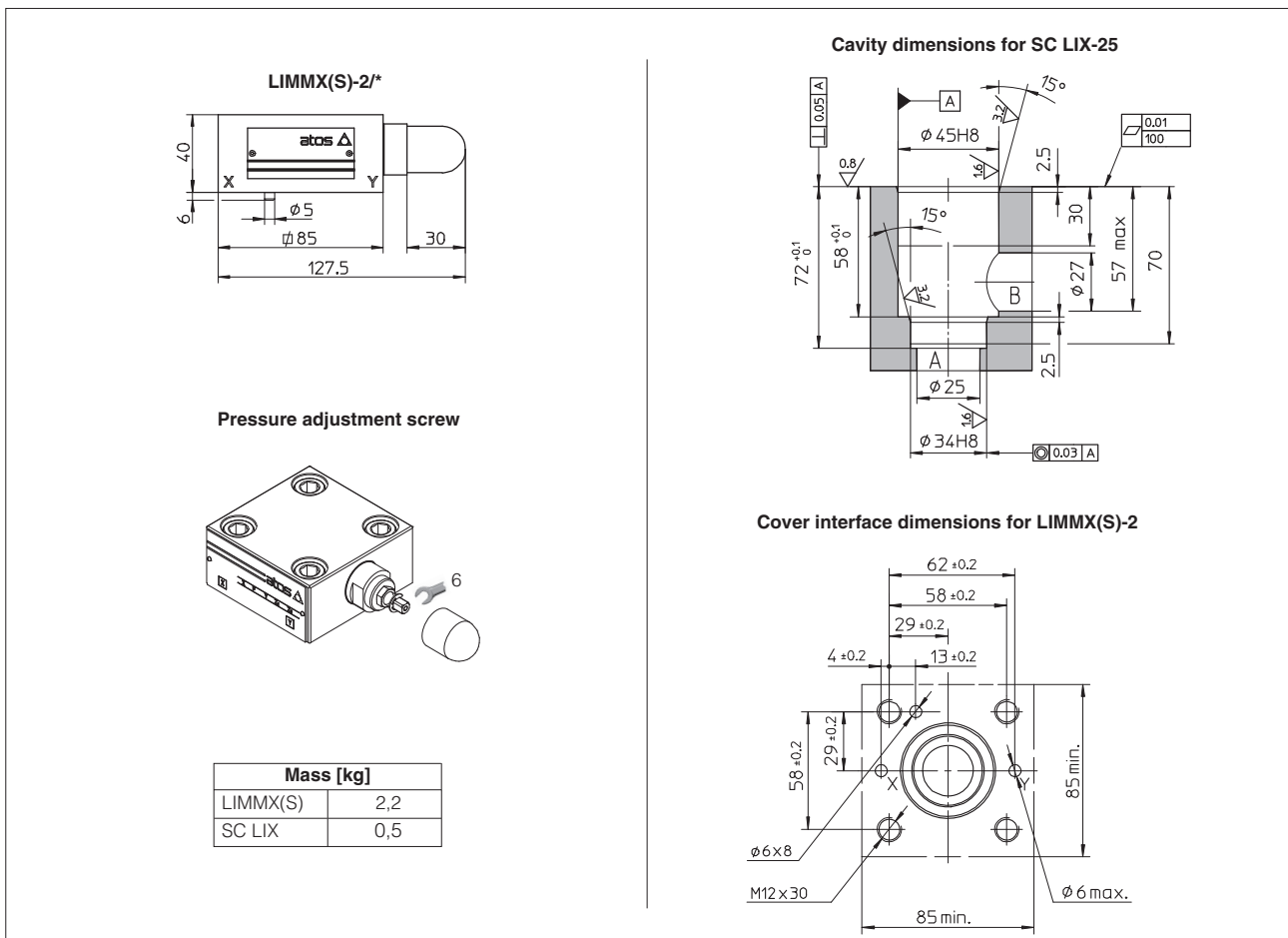

10 RELATED DOCUMENTATION

- W010** Basics for electrohydraulics in corrosive environments
- W020** Summary of Atos stainless steel components
- EW900** Operating and maintenance information for stainless steel on-off valves

Cable glands and plugs for ex-proof valves

Multicertified ATEX, IECEx, EAC

1 MULTICERTIFIED CABLE GLAND FOR NON-ARMOURED CABLES - Group II (surface plants)

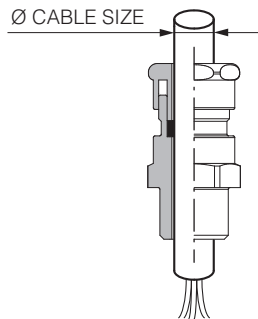

Cable glands for use with non-armoured plastic insulated cables
 Flameproof **Exd IIC Gb**, Increased Safety **Exe IIC Gb** and Dust **Extb IIIC Db II 2 GD**, suitable for use in Zone 1, Zone 2, Zone 21, Zone 22.

Construction and Test Standards: IEC/EN 60079-0, IEC/EN60079-1, IEC/EN 60079-7 and IEC/EN 60079-31.

Ingress Protection: IP66, IP67 and IP 68 (30 meters for 7 days) to IEC/EN 60529 and NEMA 4X Deluge Protection to DTS01

Operating Temperature Range: -60 °C to +100 °C

Material: Nickel Plated Brass or AISI 316

Cable glands are marked ATEX, IECEx and EAC

The electric cable must be suitable for the working temperature as specified in the "safety instructions" delivered with the first supply of Atos ex-proof valves.

See section 4 for cable gland assembly.

CABLE GLAND CODE AND DIMENSIONS	MULTICERTIFICATION	CHARACTERISTICS	VALVE TYPE
<p>PAMC/GK</p> <p>Tightening torque: 20 Nm</p>	<p>Referred to certificates: - Baseefa 06 ATEX0056X - IECEx BAS 06.0013X</p> <p>Item type: 501-421</p> <p>ATEX: EN 60079-0, EN 60079-1, EN 60079-7 and EN 60079-31</p>	<p>Material: Nickel plated brass</p> <p>Threaded connection: GK-1/2" ISO/UNI-6125 (tapered)</p> <p>Cable size: 6,5 to 11,9 mm</p>	<p>On-off and proportional ex-proof valves with "GK" threaded connection (solenoid and LVDT transducer)</p> <p>Approved only for the Italian market</p>
<p>PAMC/M</p> <p>Tightening torque: 20 Nm</p>	<p>IECEx: IEC 60079-0, IEC 60079-1, IEC 60079-7 and IEC 60079-31</p>	<p>Material: Nickel plated brass</p> <p>Threaded connection: M20x1,5 UNI-4535</p> <p>Cable size: 6,5 to 11,9 mm</p>	<p>On-off and proportional ex-proof valves with "M" threaded connection (solenoid, LVDT transducer and on-board driver)</p>
<p>PAMC/NPT</p> <p>Tightening torque: 20 Nm</p>	<p>EAC: EN60079-0 and EN60079-1</p>	<p>Material: Nickel plated brass</p> <p>Threaded connection: 1/2" NPT ANSI/ASME B1.20.1 (tapered)</p> <p>Cable size: 6,5 to 11,9 mm</p>	<p>On-off and proportional ex-proof valves with "NPT" threaded connection (solenoid and LVDT transducer)</p>
<p>PAXMC/M</p> <p>Tightening torque: 20 Nm</p>		<p>Material: Stainless steel AISI 316</p> <p>Threaded connection: M20x1,5 UNI-4535</p> <p>Cable size: 6,5 to 11,9 mm</p>	<p>On-off ex-proof stainless steel valves type "X" and "XS"</p>

2 MULTICERTIFIED CABLE GLAND FOR ARMoured CABLES - Group II (surface plants)

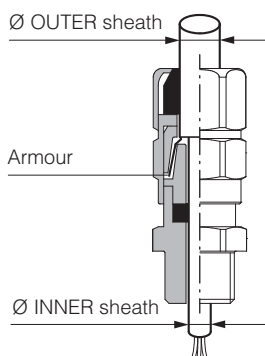

Cable glands for use with single wire armour 'W', wire braid 'X', steel tape armour 'Z', plastic insulated cables.
 Flameproof **Exd IIC Gb**, Increased Safety **Exe IIC Gb**, Dust **Extb IIIC Db** and **ExnR IIC Gc II 2 / 3GD**, suitable for use in Zone 1, Zone 2, Zone 21, Zone 22.
 Construction and Test Standards: IEC/EN 60079-0, IEC/EN 60079-1, IEC/EN 60079-7, IEC/EN 60079-15 and IEC/EN 60079-31.
 Ingress Protection: IP66, IP67 and IP 68 (30 meters for 7 days) to IEC/EN 60529 and NEMA 4X Deluge Protection to DTS01.
 Operating Temperature Range: -60 °C to +80 °C

Seal on the cable inner sheath
 Outer deluge seal to prevent moisture ingress to the cable armour / braid
 Cable retention, low smoke
 Material: Nickel Plated Brass or AISI 316
 Cable glands are marked ATEX, IECEx and EAC

The electric cable must be suitable for the working temperature as specified in the "safety instructions" delivered with the first supply of Atos ex-proof valves.

See section 4 for cable gland assembly.

CABLE GLAND CODE AND DIMENSIONS	MULTICERTIFICATION	CHARACTERISTICS	VALVE TYPE
<p>PAAMC/GK</p> <p>~90 Tightening torque: 20 Nm 1/2" GK (1/2" BSPT)</p>	<p>Referred to certificates: - Baseefa 06 ATEX0056X - IECEx BAS 06.0013X</p> <p>Item type: 501-453RAC</p>	<p>Material: Nickel plated brass</p> <p>Threaded connection: GK-1/2" ISO/UNI-6125 (tapered)</p> <p>Cable size: INNER sheath size 3,2 to 8 mm OUTER sheath size 5,5 to 12 mm</p>	<p>On-off and proportional ex-proof valves with "GK" threaded connection (solenoid and LVDT transducer)</p> <p>Approved only for the Italian market</p>
<p>PAAMC/M</p> <p>~55 Tightening torque: 20 Nm M20x1.5</p>	<p>ATEX: EN 60079-0, EN 60079-1, EN 60079-7 and EN 60079-31</p> <p>IECEx: IEC 60079-0, IEC 60079-1, IEC 60079-7 and IEC 60079-31</p>	<p>Material: Nickel plated brass</p> <p>Threaded connection: M20x1,5 UNI-4535</p> <p>Cable size: INNER sheath size 3,2 to 8 mm OUTER sheath size 5,5 to 12 mm</p>	<p>On-off and proportional ex-proof valves with "M" threaded connection (solenoid, LVDT transducer and on-board driver)</p>
<p>PAAMC/NPT</p> <p>~55 Tightening torque: 20 Nm 1/2" NPT</p>	<p>EAC: EN60079-0 and EN60079-1</p>	<p>Material: Nickel plated brass</p> <p>Threaded connection: 1/2" NPT ANSI/ASME B1.20.1 (tapered)</p> <p>Cable size: INNER sheath size 3,2 to 8 mm OUTER sheath size 5,5 to 12 mm</p>	<p>On-off and proportional ex-proof valves with "NPT" threaded connection (solenoid and LVDT transducer)</p>
<p>PAAXMC/M</p> <p>~55 Tightening torque: 20 Nm M20x1.5</p>		<p>Material: Stainless steel AISI 316</p> <p>Threaded connection: M20x1,5 UNI-4535 (6H/6g)</p> <p>Cable size: INNER sheath size 3,2 to 8 mm OUTER sheath size 5,5 to 12 mm</p>	<p>On-off ex-proof stainless steel valves type "X" and "XS"</p>

3 MULTICERTIFIED CABLE GLAND FOR ARMoured CABLES - Group I (Mining)

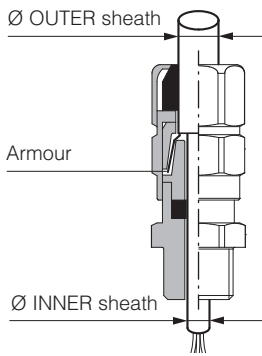

Cable glands for use with single wire armour 'W', wire braid 'X', steel tape armour 'Z', plastic insulated cables.

Flameproof **Exd I M2** and Increased Safety **Exe I M2**, suitable for use in Mines
 Construction and Test Standards: IEC/EN 60079-0, IEC/EN 60079-1 and IEC/EN 60079-7
 Ingress Protection: IP66, IP67 and IP 68 (30 meters for 7 days) to IEC/EN 60529
 Operating Temperature Range: -60 °C to +80 °C

Seal on the cables inner sheath
 Cable retention, low smoke
 Material: Nickel Plated Brass
 Cable glands are marked ATEX, IECEx and EAC

The electric cable must be suitable for the working temperature as specified in the "safety instructions" delivered with the first supply of Atos ex-proof valves.

See section 4 for cable gland assembly.

CABLE GLAND CODE AND DIMENSIONS	MULTICERTIFICATION	CHARACTERISTICS	VALVE TYPE
<p>PAAMMC/GK</p> <p>Tightening torque: 20 Nm</p>	<p>Referred to certificates: - Baseefa 08 ATEX0331X - IECEx BAS 08.0112X</p> <p>Item type: 453RAC</p> <p>ATEX: EN 60079-0, EN 60079-1, EN 60079-7 and EN 60079-31</p>	<p>Material: Nickel plated brass</p> <p>Threaded connection: GK-1/2" ISO/UNI-6125 (tapered)</p> <p>Cable size: INNER sheath size 3 to 8 mm OUTER sheath size 5,5 to 12 mm</p>	<p>On-off and proportional ex-proof valves with "GK" threaded connection (solenoid and LVDT transducer)</p> <p>Approved only for the Italian market</p>
<p>PAAMMC/M</p> <p>Tightening torque: 20 Nm</p>	<p>IECEx: IEC 60079-0, IEC 60079-1, IEC 60079-7 and IEC 60079-31</p> <p>EAC: EN60079-0 and EN60079-1</p>	<p>Material: Nickel plated brass</p> <p>Threaded connection: M20x1,5 UNI-4535</p> <p>Cable size: INNER sheath size 3 to 8 mm OUTER sheath size 5,5 to 12 mm</p>	<p>On-off and proportional ex-proof valves with "M" threaded connection (solenoid, LVDT transducer and on-board driver)</p>
<p>PAAMMC/NPT</p> <p>Tightening torque: 20 Nm</p>	<p>EAC: EN60079-0 and EN60079-1</p>	<p>Material: Nickel plated brass</p> <p>Threaded connection: 1/2" NPT ANSI/ASME B1.20.1 (tapered)</p> <p>Cable size: INNER sheath size 3 to 8 mm OUTER sheath size 5,5 to 12 mm</p>	<p>On-off and proportional ex-proof valves with "NPT" threaded connection (solenoid and LVDT transducer)</p>

4 CABLE GLAND ASSEMBLY

Cable glands PAMC/* and PAXMC/M for non-armoured cables

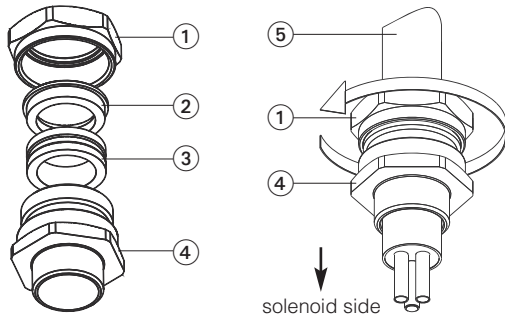

Assembling procedure

Unscrew the Back-nut ① from Entry ④
 Push the electric cable ⑤ through the cable gland
 Connect the cable wires to the solenoid terminal board
 Screw-in the Entry ④ into the solenoid cable entrance
 lock it at relevant tightening torque specified in section 1
 Lock the Back-nut ① using a wrench until a resistance is felt between internal seal ③ and the cable
 Turn the Back-nut ① through a further half turn to ensure the complete inner sealing

- ① Back-nut
- ② Compression Spigot
- ③ Seal
- ④ Entry
- ⑤ Electric cable (non-armoured)

Cable glands PAAMC/*, PAAXMC/M and PAAMMC/* for armoured cables

STEP 1

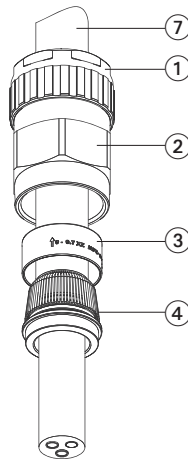

STEP 2

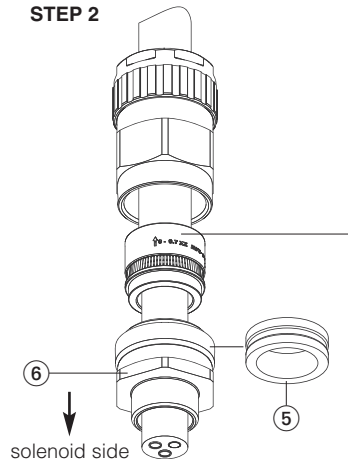

- ① Back-nut
- ② Middle-nut
- ③ Reversible Armour Clamping Ring (RAC)
- ④ Armour Spigot
- ⑤ Inner Seal
- ⑥ Entry (with captive deluge seal), if required
- ⑦ Electric cable (armour type SWA, Braid X, Flat Steel wire Y, Steel type Z)

Reversible Armour Clamping ring (RAC) orientation

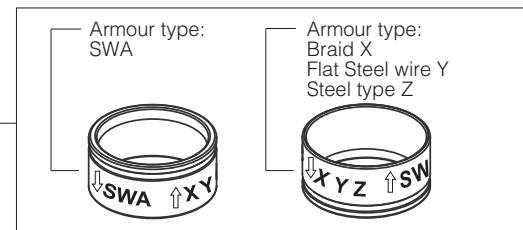

Note: the arrow corresponding to the correct armour type (SWA or X, Y, Z) must be oriented towards the ex-proof solenoid

Assembling procedure

STEP 1

Unscrew Back-nut ① from Middle-nut ② and Entry ⑥, push the cable through the Armour Spigot ④
 Spread the armour over the Armour spigot ④ until the end of the armour is up against the shoulder of the armour cone
 Position the Armour clamping ring ③ paying attention to its correct orientation depending to the armour type (see above)
 Remove the Inner seal ⑤ from the Entry ⑥, place the Entry ⑥ over the Armour Spigot ④
 Move the sub-assembly ① + ② to meet the Entry ⑥, connect the cable wires to the solenoid terminal board
 Screw-in the Entry ⑥ into the solenoid cable entrance and lock it at relevant tightening torque specified in section 2 and 3

Hand tighten the Middle-nut ② to the Entry ⑥ and turn a further half turn with a wrench

Unscrew the Middle-nut ② and visually inspect that the armour has been successfully clamped between the armour spigot ④ and the armour clamping ring ③. If the armour is not correctly clamped, repeat the assembly

STEP 2

Re-assemble Middle-nut ② onto the components ③ + ④ + ⑤ + ⑥ paying attention to the correct orientation of the reversible armour Clamping ring ③, tighten up the Middle-nut ② by hand first and then using a wrench a further 1 to 2 turns until fully tight

Hand tighten the Back-nut ① then tighten a further full turn using a wrench

Ensure that the Middle-nut ② does not rotate when tightening the Back-nut ①

Ensure that the deluge seal is compressed into correct position

5 THREADED PLUG

THREADED PLUG CODE AND DIMENSIONS	MULTICERTIFICATION	CHARACTERISTICS	VALVE TYPE
<p>ZMX-T</p> <p>Tightening torque: 20 Nm</p>	<p>CE</p> <p>ATEX: EN 60079-0, EN 60079-1, EN 60079-7 and EN 60079-31</p> <p>IECEx</p> <p>IECEx: IEC 60079-0, IEC 60079-1, IEC 60079-7 and IEC 60079-31</p> <p>EAC</p> <p>EAC: EN60079-0 and EN60079-1</p>	<p>Material: Nickel plated brass</p> <p>Threaded connection: M20x1,5 UNI-4535</p>	<p>Proportional ex-proof valves with on-board driver</p>

Stainless steel hydraulic cylinders type CNX

ISO 6020-1, round heads with counterflanges, Pnom 10 MPa (100 bar), Pmax 15 MPa (150 bar)

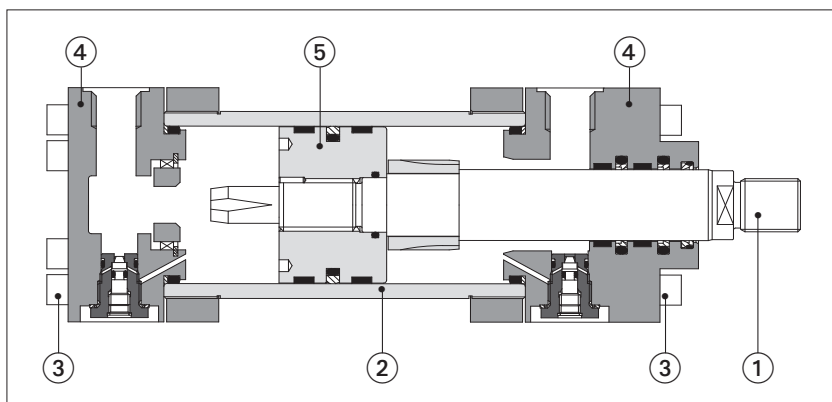

CNX cylinders are derived from standard CN (tab. B180) with stainless steel construction to withstand extreme and corrosive environmental conditions and to ensure compatibility with water based fluids or pure water.

They are ideally suited for a variety of applications and industries including: pharmaceutical, marine, military, waste management, offshore and chemical processing.

- Bore sizes from **50 to 100 mm**
- Strokes up to **3000 mm**
- Rods with rolled threads
- **9** standard mounting styles
- **3** seals options
- Rod guide rings for low wear
- Adjustable or fixed cushioning
- Optional built-in position transducer, **see tab. B310**

Stainless steel attachments are available on request, for dimensions **see tab. B500**
For cylinder dimensions and options **see tab. B180**

1 MATERIALS AND SPECIFICATIONS

Cylinder component	Material	Features
ROD ① and PISTON ⑤	AISI 431	High strength and good corrosion resistance
HOUSING ② and HEADS ④	AISI 316L	Optimum corrosion resistance
SCREWS ③	AISI 316 A4	Optimum corrosion resistance and high strength

2 MODEL CODE

CNX	F	-	63	/	45	*	0500	-	S	3	0	8	-	A	-	B1E3X1Z3	**																									
<p>Cylinder series CNX to ISO 6020 - 1</p> <p>Rod position transducer see section 4 - = omit if not requested F = magnetosonic M = magnetosonic programmable N = magnetostrictive P = potentiometric V = inductive Transducer available on request, contact our technical office</p> <p>Bore size, see section 6 from 50 to 100 mm</p> <p>Rod diameter, see sections 6 from 36 to 70 mm</p> <p>Stroke (1) up to 3000 mm</p> <p>Mounting style (1)</p> <table style="width: 100%; border: none;"> <tr> <td style="width: 50%; border: none;">A = front round flange</td> <td style="width: 50%; border: none;">MF3</td> </tr> <tr> <td style="border: none;">B = rear round flange</td> <td style="border: none;">MF4</td> </tr> <tr> <td style="border: none;">D = fixed eye</td> <td style="border: none;">MP3</td> </tr> <tr> <td style="border: none;">E = feet</td> <td style="border: none;">MS2</td> </tr> <tr> <td style="border: none;">L = intermediate trunnion</td> <td style="border: none;">MT4 (3)</td> </tr> <tr> <td style="border: none;">N = front square flange</td> <td style="border: none;">MF1</td> </tr> <tr> <td style="border: none;">P = rear square flange</td> <td style="border: none;">MF2</td> </tr> <tr> <td style="border: none;">S = fixed eye + spherical bearing</td> <td style="border: none;">MP5</td> </tr> <tr> <td style="border: none;">X = basic execution</td> <td style="border: none;">-</td> </tr> </table> <p>REF. ISO</p> <p>Spacer (1) 0 = none 2 = 50 mm 4 = 100 mm 6 = 150 mm 8 = 200 mm</p> <p>Cushioning (1) 0 = none</p> <table style="width: 100%; border: none;"> <tr> <td style="width: 50%; border: none;">Fast adjustable</td> <td style="width: 50%; border: none;">Fast fixed</td> </tr> <tr> <td style="border: none;">1 = rear only</td> <td style="border: none;">7 = rear only</td> </tr> <tr> <td style="border: none;">2 = front only</td> <td style="border: none;">8 = front only</td> </tr> <tr> <td style="border: none;">3 = front and rear</td> <td style="border: none;">9 = front and rear</td> </tr> </table> <p>Sealing system, see section 5 3 = (FKM + PTFE) very low friction, high temperatures and water based fluids 5 = (NBR + PTFE) very low friction, high speeds and water based fluids 8 = (NBR + PTFE and POLYURETHANE) high static and dynamic sealing</p> <p>Options (1) (2): Air bleeds A = front air bleed W = rear air bleed</p> <p>Heads' configuration (1) (2) Oil ports positions B1 = front head X1 = rear head Cushioning adjustments positions, to be entered only if adjustable cushioning are selected E3 = front head* Z3 = rear head* * = enter E2 and Z2 for mounting style E</p> <p>Series number</p>																	A = front round flange	MF3	B = rear round flange	MF4	D = fixed eye	MP3	E = feet	MS2	L = intermediate trunnion	MT4 (3)	N = front square flange	MF1	P = rear square flange	MF2	S = fixed eye + spherical bearing	MP5	X = basic execution	-	Fast adjustable	Fast fixed	1 = rear only	7 = rear only	2 = front only	8 = front only	3 = front and rear	9 = front and rear
A = front round flange	MF3																																									
B = rear round flange	MF4																																									
D = fixed eye	MP3																																									
E = feet	MS2																																									
L = intermediate trunnion	MT4 (3)																																									
N = front square flange	MF1																																									
P = rear square flange	MF2																																									
S = fixed eye + spherical bearing	MP5																																									
X = basic execution	-																																									
Fast adjustable	Fast fixed																																									
1 = rear only	7 = rear only																																									
2 = front only	8 = front only																																									
3 = front and rear	9 = front and rear																																									

(1) For details see **tab. B180**

(2) To be entered in alphabetical order

(3) XV dimension must be indicated in the model code, see **tab. B180**

3 STAINLESS STEEL PROPERTIES

CNX cylinders are manufactured with selected stainless steel to withstand extended exposure to aggressive environments, the table at side shows the compatibility of AISI 316L and AISI 431 with the main aggressive substances.
The rod is chromeplated: chrome thickness 0,020 mm; hardness 850-1150 HV.
The low strength of AISI 316L limits the max pressure to 150 bar; for heavy duty applications AISI 630 is recommended, contact our technical office.

Material	Cylinder component	Mechanical properties		Corrosion resistance (2)
		Rm min [MPa]	Rs min [MPa]	
AISI 316L	housing and heads	450	195	> 1200 h
AISI 316 A4 70	screws	700	450	> 1200 h
AISI 431	piston and rod	800	600	> 600 h
AISI 420	Spherical bearing of style S	700	500	< 100 h
AISI 630 (17-4 ph) (1)	housing and rod	860	724	> 1000 h

Note: (1) Available on request for heavy duty applications
(2) Corrosion resistance in neutral salt spray to ISO 9227 NSS

Corrosion index for AISI 316L and AISI 431

Substance	Corrosion index	
	AISI 316L	AISI 431
Marine atmospheres	very good	good
Salt water	good	sufficient
33% Acetic acid	excellent	limited
2% Muriatic acid	good	limited
70% Phosphoric acid	limited	limited
65% Nitric acid	good	good
2% Sulfuric acid	excellent	limited
20% Sulfuric acid	limited	limited

4 CNX WITH BUILT-IN POSITION TRANSDUCER

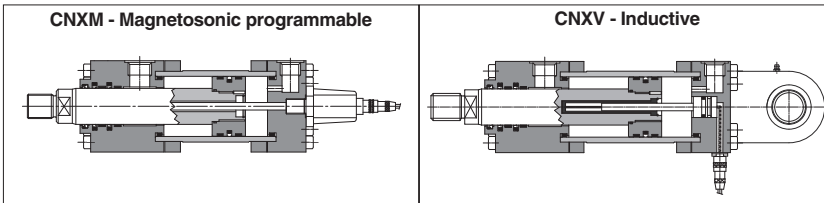

CNX cylinders are also available with magnetostrictive, potentiometric and inductive rod position transducers.
Stainless steel or aluminum materials used for transducers components make CNX servocylinders ideal for extreme working conditions as aggressive external environments or corrosive fluids.
For transducer performance and other details see **tab. B310**

5 SEALING SYSTEM FEATURES

The sealing system must be chosen according to the working conditions of the system: speed, fluid type and temperature.
For HFA fluids or pure water it is recommended the use of proper additives to increase the sealing working life. Contact our technical office to check the compatibility with other fluids not mentioned below and specify type and composition.

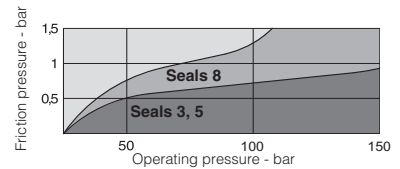

Sealing system	Material	Features	Max speed [m/s]	Fluid temperature range	Fluids compatibility	ISO Standards for seals	
						Piston	Rod
3	FKM + PTFE	very low friction and high temperatures	4	-20°C to 120°C	Mineral oils HH, HL, HLP, HLP-D, HM, HV fire resistance fluids HFA, HFB, HFD-U, HFD-R and water	ISO 7425/1	ISO 7425/2
5	NBR + PTFE	very low friction and high speeds	4	-20°C to 85°C	Mineral oils HH, HL, HLP, HLP-D, HM, HV, MIL-H-5606; fire resistance fluids HFA, HFC (water max 45%), HFD-U and water	ISO 7425/1	ISO 7425/2
8	NBR + PTFE + POLYURETHANE	high static and dynamic sealing	1	-20°C to 85°C	Mineral oils HH, HL, HLP, HLP-D, HM, HV	ISO 7425/1	ISO 7425/2

6 BORE / ROD SIZES

Ø Bore	50	63	80	100
Ø Rod	36	45	56	70

The table at side shows the available bore/rod sizes, see **tab. B180** for installation dimensions and options.

7 CYLINDER SECTION

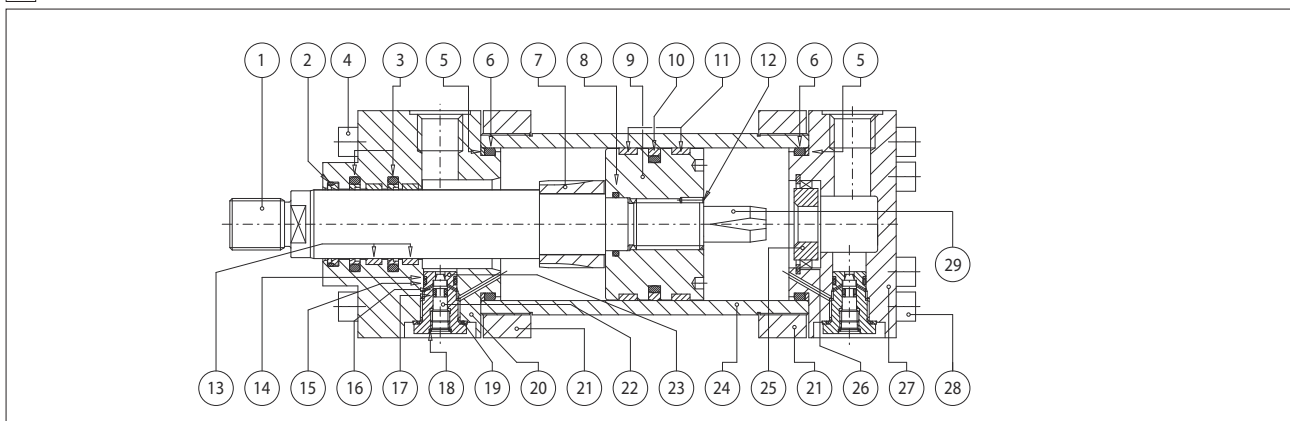

POS.	DESCRIPTION	MATERIAL	POS.	DESCRIPTION	MATERIAL	POS.	DESCRIPTION	MATERIAL
1	Rod	AISI431 Chromeplated	11	Piston guide rings	PTFE	21	Counterflange	AISI 316L
2	Wiper	NBR / FKM and PTFE	12	Screw stop pin	AISI 304 / AISI 316L	22	Cushioning adjustment screw	AISI 316L
3	Rod seal	NBR / FKM and PTFE	13	Rod guide rings	PTFE	23	Cushioning adjustment plug	AISI 316L
4	Screw	AISI 316 A4	14	Anti-extrusion ring	PTFE	24	Cylinder housing	AISI 316L
5	Anti-extrusion ring	PTFE	15	O-ring	FKM	25	Rear cushioning sleeve	Bronze
6	O-ring	NBR / FKM	16	O-ring	FKM	26	Toroidal ring	AISI 304 / AISI 316L
7	Front cushioning piston	AISI 431	17	Anti-extrusion ring	PTFE	27	Rear head	AISI 316L
8	O-ring	NBR / FKM	18	Seeger	AISI 304 / AISI 316L	28	Screw	AISI 316 A4
9	Piston	AISI 431	19	Seal	FKM	29	Rear cushioning piston	AISI 431
10	Piston seal	NBR / FKM and PTFE	20	Front head	AISI 316L			

Operating and maintenance information for stainless steel on-off valves

ex-proof solenoid valves, hydraulic operated directional valves, pressure relief valves

This operating and maintenance information applies to Atos stainless steel on-off valves and is intended to provide useful guidelines to avoid risks when the valves are installed in the hydraulic system, particularly for components operating in hazardous areas with explosive or flammable environment.



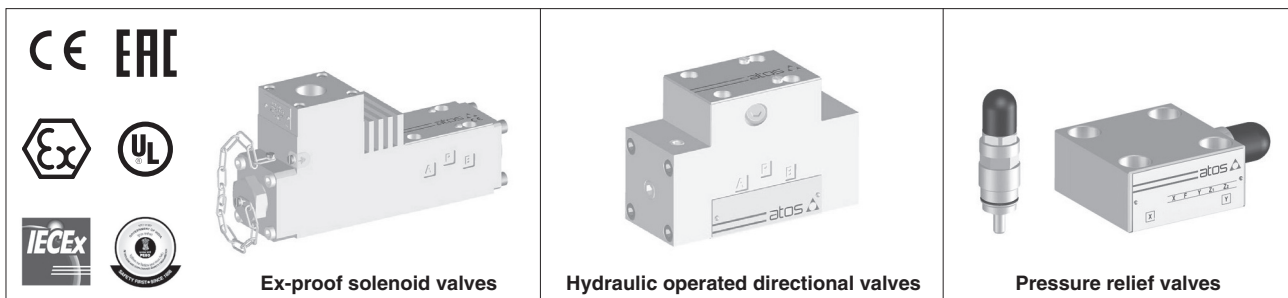

The prescriptions included in this document must be strictly observed to avoid damages and injury. The respect of this operating and maintenance information grants an increased working life, trouble-free operation and thus reduced repairing costs.



1 SYMBOL CONVENTIONS

Following symbols are used in this documentation to evidence risks to be carefully avoided.

In the following are listed the symbol conventions with their meaning, in case of non-compliance with this operating and maintenance information.

 WARNING	Death or serious injury could occur	risk classes to ANSI Z535.6 / ISO 3864
 CAUTION	Minor or moderate injury could occur	
NOTICE	Property damage could occur	
	Notes relevant to stainless steel ex-proof solenoid directional valves with Multicertification	
	Notes relevant to stainless steel ex-proof solenoid directional valves with cULus North American certification	
	Information to be observed	

2 GENERAL NOTES

This document is relevant to the installation, use and maintenance of Stainless steel on-off directional and pressure control valves.

On-off solenoid directional valves are equipped with ex-proof solenoids type OAX(S)-* for application in explosive hazardous environments.

2.1 Warranty

All the ex-proof on-off valves have 1 year warranty; the expiration of warranty results from the following operations:

- unauthorized mechanical or electronic interventions
- the ex-proof on-off valves are not used exclusively for their intended purpose as defined in these operating and maintenance instructions



Service work performed on the valve by the end users or not qualified personnel invalidates the certification

3 CERTIFICATIONS

3.1 Ex-proof certification and protection mode

The ex-proof on-off solenoids subject of this operating and maintenance information are multicertified ATEX, IECEx, EAC, PESO or cULus They are in compliance with following protection mode:

Multicertification Group II – ATEX, IECEx, EAC, PESO

cULus Noth American certification



II 2 G Ex d IIC T6, T4, T3 Gb

Class I, Div. I, Groups C & D

T. class T4/T3



II 2 D Ex tb IIC T85°C, T135°C, T200°C Db

Class I, Zone I, Groups II A & II B

T. class T4/T3

3.2 SIL certification in accordance with IEC 61508

Valves DHAX, DHAXS, DLAHX, DLAHXS, DLPX and DLPXS are TUV certified in compliance with IEC EN 61508:2010 as being suitable for use in safety-related application up to SIL 3.

This manual covers all installation, maintenance and operation requirements for these applications.

4 HARMONIZED STANDARDS



The Essential Health and Safety Requirements are assured by compliance to the following standards:

ATEX

- EN 60079-0 Explosive atmospheres - Equipment: General requirements
- EN 60079-1 Explosive atmospheres - Equipment protection by flameproof enclosures "d"
- EN 60079-31 Explosive atmospheres - Equipment dust ignition protection by enclosures "t"

IECEx

- IEC 60079-0 Explosive atmospheres - Part 0: General requirements
- IEC 60079-1 Explosive atmospheres - Part 1: Equipment protection by flameproof enclosures "d"
- IEC 60079-31 Explosive atmospheres - Part 31: Equipment dust ignition protection by enclosures "t"

cULus

- UL 1203 Standard for Explosion-Proof and Dust-Ignition-Proof Electrical Equipment for use in Hazardous (classified) locations
- UL 429 Standard for Electrically Operated valves
- CSA C22.2 No.139-13 Electrically Operated Valves

5 GENERAL CHARACTERISTICS

Ambient temperature range	Standard = -40°C ÷ +60°C /PE option = -20°C ÷ +60°C /BBT option = -60°C ÷ +70°C
Storage temperature range	Standard = -40°C ÷ +70°C /PE option = -20°C ÷ +70°C /BBT option = -60°C ÷ +80°C
Compliance	Explosion proof protection (for valves with ex-proof solenoid) -Flame proof enclosure "Ex d" -Dust ignition protection by enclosure "Ex t" SIL to IEC 61508: 2010, see section 3.2 RoHs Directive 2011/65/EU as last update by 2015/65/EU REACH Regulation (EC) n°1907/2006

6 HYDRAULIC CHARACTERISTICS

See technical tables relevant to the specific components, listed in section 12

7 ELECTRIC CHARACTERISTICS - for ex-proof solenoid directional valves



Harmonized standard	Multicertification	cULus
Power consumption at 20°C	8W or 25W	12W or 33W

See technical tables relevant to the specific components, listed in section 12

8 PRODUCT IDENTIFICATION NAMEPLATES
ATEX, IECEx, EAC and PESO multicertification



Gas - group II 2G - Zone 1, 2
Dust - group II 2D - Zone 21, 22

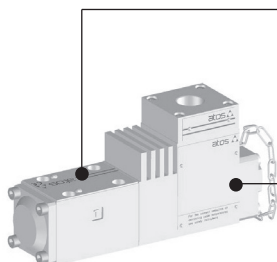

Valve nameplate

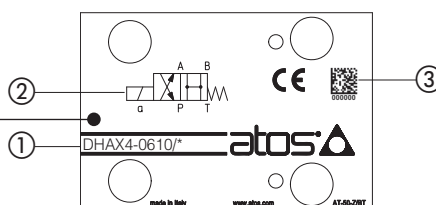

- ① Valve code
- ② Hydraulic symbol
- ③ Valve serial number

Ex-proof solenoid nameplate

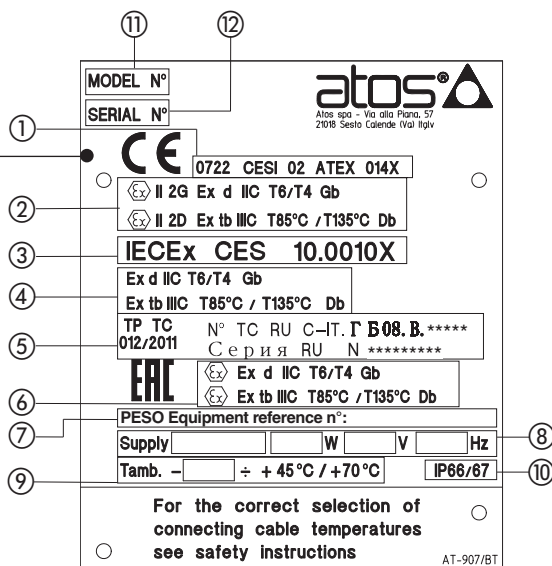

- ① ATEX notified body and certificate number
- ② Marking according to ATEX Directive
- ③ IECEx notified body and certificate number
- ④ Marking according to IECEx Scheme
- ⑤ EAC notified body and certificate number
- ⑥ Marking according to EAC
- ⑦ PESO certificate number
- ⑧ Power supply characteristics
- ⑨ Ambient temperature
- ⑩ Ingress protection:
 -IP66 = no dust ingress, protection against heaving seas or powerful jets of water
 -IP67 = no dust ingress, protection to water immersion
- ⑪ Solenoid model code
- ⑫ Solenoid serial number

	Mark of conformity to the applicable European directives
	Mark of conformity to the 2014/34/UE directive and to the relevant technical norms
II 2 G	Equipment for surface plants with gas or vapors environment, category 2, suitable for zone 1 and 2
Ex d	Explosion-proof equipment
II C	Group II C equipment suitable for substances (gas) for group II C
T6, T4, T3	Equipment temperature class (maximum surface temperature)
Gb	Equipment protection level, high level protection for explosive Gas atmospheres
II 2 D	Equipment for surface plants with dust environment, category 2, suitable for zone 21 and zone 22
Ex tb	Equipment protection by enclosure "tb"
IIIC	Suitable for conductive dust (applicable also IIIB and/or IIIA)
IP66/67	Protection degree
T85°C, T135°C, T200°C,	Maximum surface temperature (Dust)
Db	Equipment protection level, high level protection for explosive Dust atmospheres
CESI 02 ATEX 014 X	Name of the laboratory responsible for the CE certification: 02 year of the certification release; 014 X certification number
0722	Number of the Notified Body authorized for the production quality system certification: 0722 = CESI
IECEx CES 10.0010X	Certificate number: CES laboratory name responsible for the IEC Ex certification scheme: 10 year of the certification release; 0010X number of certification
T amb.	Ambient temperature range

8.2 Ex-proof solenoid directional valves

cULus certification
Class I, Division 1
Class I, Zone 1

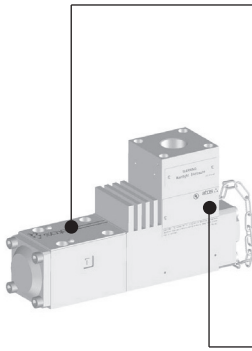

Valve nameplate

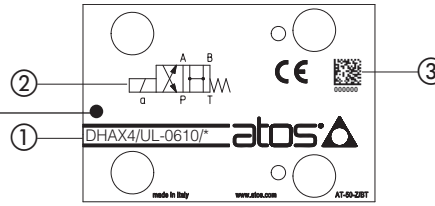

- ① Valve code
- ② Hydraulic symbol
- ③ Valve serial number

Ex-proof solenoid nameplate

① MODEL CODE

② SERIAL N°

③ Class I, Div. I, Groups C & D T. class T6/T5
Class I, Zone I, Groups IIA & IIB T. class T6/T5

④ Max ambient temp. 55/70 °C 131/158 °F

⑤ Electrical rating : 24 V DC 12W

⑥

CAUTION: To reduce the risk of ignition of hazardous atmospheres, disconnect from circuit before opening enclosure. Keep tightly closed when in operation.

ATTENTION: Pour réduire le risque d'allumage des atmosphères dangereuses, déconnecter le circuit avant d'ouvrir le boîtier. Garder le bien fermé lorsqu'il est en fonctionnement

T-880

- ① cULus marking and certificate number
- ② Marking according to NEC 500 and NEC 505 standards
- ③ Ambient temperature
- ④ Power supply characteristics
- ⑤ Solenoid model code
- ⑥ Solenoid serial number

	cULus mark and certificate number
Class I	Equipment for flammable gas and vapours
Division I	Explosive substances continuously or intermittently present in the atmosphere
Groups C & D	Gas group C (Methane, Buthane, Petrol, etc) and D (Etylene, Formaldeyde, Cloruprophane, etc)
Zone I	Location where explosive substances are continuously present
Groups IIA & IIB	Equipment of group IIA and IIB suitable for gas of group IIA and IIB
Class T6/T5	Solenoid temperature class (maximum surface temperature)
Max ambient temp.	Max ambient temperature range in °C and °F

8.3 Hydraulic operated valves

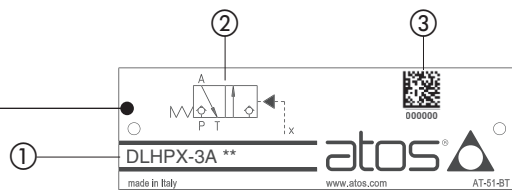
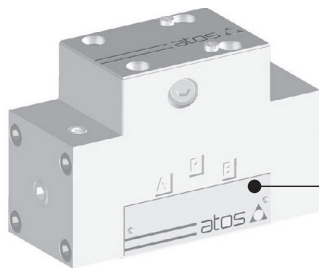

- ① Valve code
- ② Hydraulic symbol
- ③ Valve serial number

8.4 Pressure relief valve

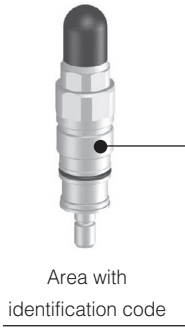

Identification code	Max pressure (bar)	
	CART MX(S)-3	CART MX(S)-6
1	100	100
2	210	210
3	350	350
4	50	420
9	420	

Identification code	Max pressure (bar)
	CART AREX(S)-20
50	50
100	100
210	210
315	315
400	400



- ① Valve code
- ② Hydraulic symbol
- ③ Valve serial number



- ① Valve code
- ② Valve serial number

9 SAFETY NOTES

9.1 Intended use

Atos stainless steel valves are intended for integration in industrial systems and machines or for the assembly with other components to form a machine or a system. They may only be operated under the environmental and operating conditions described in the valves technical tables.

9.2 Improper use

Improper use of the components includes:

- Wrong installation / installation in areas not approved for the specific component (for ex-proof valves)
- Incorrect storage
- Incorrect transport
- Lack of cleanliness during storage and installation
- Incorrect installation
- Use of inappropriate or non-admissible fluids
- Operation outside the specified performance limits
- Operation outside the approved temperature range

Atos spa does not assume any liability for damage caused by improper use. The user assumes all risks involved with improper use.

9.3 Installation



The installation or use of inappropriate components in explosive hazardous environments could cause personal injuries and damage to property.

For the application in explosion hazardous environments, the compliance of the solenoid with the zone classification and with the flammable substances present in the system must be verified.

The main safety requirements against the explosion risks in the classified areas are established by the European Directives 2014/34/UE (for the components) and 99/92/CE (for the plants and safety of the workers against the risk of explosion).

The classification criteria of the area against the explosion risks are established by the norm EN60079-10.

The technical requirements of the electrical systems are established by the norm EN60079-14 (group II).

Note: the max fluid temperature controlled by the valve must not exceed + 60°C



WARNING

Ensure that no explosive atmosphere may occur during the valve installation.

Only use the valve in the intended explosion protection area.

The ignition temperature of the hydraulic fluid used must be 50°C higher than the maximum surface temperature of the valve.



WARNING: non-compliance with functional safety

In case of mechanical or electric failures, risk of death or persons injury could occur.

Functional safety prescriptions according to EN ISO 13849 must be observed in the hydraulic circuit.



WARNING: hot surface

The valve considerably heats up during operation. Allow the valve to cool down sufficiently before touching it.

During operation, touch the valve solenoid only by using protective gloves. Please also observe ISO 13732-1 and EN 982



CAUTION

Use of the valve outside the approved temperature range may lead to functional failures like overheating of the valve solenoid.

Only use the valve within the specified ambient and fluid temperature range.



WARNING: fixing bolts

For the valve mounting, use only class A4-70 stainless steel bolts, with dimensions and length reported in the valves technical tables.

Observe the specified tightening torque.

Using inappropriate fixing bolts or insufficient tightening torque, can cause the valve to loosen with consequent leakage of fluid under pressure which may cause personal injury and property damage.



CAUTION: pressurized systems

When working at hydraulic systems with stored energy (accumulator or cylinders working under gravity), valves may even be pressurized after the hydraulic power supply has been switched off.

During assembly and disassembly works, serious injury may be caused by a powerful leaking of hydraulic fluid jet.

Ensure that the whole hydraulic system is depressurized, and the electrical control is de-energized.



WARNING: missing equipotential bonding

Electrostatic phenomena, an incorrect earthing or missing equipotential bonding may lead to dangerous situations in case of explosive atmosphere.

Provide for correct earthing or proper equipotential bonding.



CAUTION: penetrating water and humidity

In case of use in humid or wet environments, water or humidity may penetrate at electrical connections.

This may lead to malfunctions or electric short which may result in personal injury and damage to property:

- only use the valve within the intended IP protection class
- ensure that the cable glands are correctly installed and sealed

NOTICE:

High-pressure water jets could damage the valve seals. Do not use a high-pressure washer for the valve cleaning.

NOTICE: impact

Impact or shock may damage the valves. Never use the valves as step.

NOTICE: dirt and foreign particles

Penetrating dirt and foreign particles lead to wear and malfunctions of the valves.

During assembly, be careful to prevent foreign particles such as metal chips getting into the valve or into the hydraulic system

Do not use linting fabric for the valve cleaning.

**Environmental protection**

Hydraulic fluids are harmful to the environment.

Leaking hydraulic fluid may lead to environmental pollution.

In case of fluid leakage immediately act to contain the problem.

Dispose of the hydraulic fluid in accordance with the currently applicable national regulations in your country.

Atos components do not contain substances hazardous for the environment.

The materials contained in Atos components are mainly: stainless steel, carbon steel, rubber.

Due to the high content of reusable metals, the main components of Atos can be completely recycled after disassembling of the relevant parts.

10 HYDRAULIC AND MECHANICAL INSTALLATION

10.1 Power packs tank and tubes cleaning

The power unit tank has to be accurately cleaned, removing all the contaminants and any extraneous object.

When completely assembled an accurate washing of the piping (flushing) is requested to eliminate the contaminants.

10.2 Hydraulic connections

Flexible hoses are normally used on pressure line between powerpack and the valve and on user lines to connect the actuators. If their potential breakage may cause damages to the machine or system or can cause injure to the operator, a proper retention (as the chain locking at both the pipe-ends) or alternately a protecting carter must be provided.

10.3 Hydraulic drains and return lines

Drain lines must be connected to the tank without counter pressure. The drain pipe must end above the oil level.

Return line has to be sized in order to avoid pressure peaks caused by instantaneous flow variations.

10.4 Fluid conditioning

A high-performance system must be thermally conditioned to ensure a limited fluid temperature excursion (generically between 40 and 50°C) so that the fluid viscosity remains constant during operation.

The machine working cycle should start after the prescribed temperature has been reached.

10.5 Air bleeds

Air in the hydraulic circuits affects the hydraulic stiffness and it causes malfunctioning and vibrations.

Following precautions have to be considered:

- at the system start-up all the bleeds must be released to allow the air removal
- untight the connections of the piping
- the system must be bled at first start-up or after maintenance
- a check valve (e.g. 0,5 bar) should be installed on the return line to tank to avoid emptying of the pipes following a long stop of the system

10.6 System flushing

The whole system must be flushed for a sufficient time in order to obtain the required minimum cleanliness level.

Make sure that also external pilot lines, if present in the system, are flushed.

A decisive factor for the flushing time is the contamination level of the hydraulic fluid which can only be determined by means of a particle counter.

During the flushing procedure, perform a frequent monitor of the filters clogging indicator, replacing the filter elements when required.

10.7 Hydraulic fluids and operating viscosity range

The hydraulic fluids must be compatible with the selected seals.

The type of fluid has to be selected in consideration of the effective working temperature range, so that the fluid viscosity remains at the optimal level.

Hydraulic fluid	Suitable seals type	Classification	Ref. Standard
Mineral oils	NBR low temp., FKM, FVMQ	HL, HLP, HLPD, HVLP, HVLPD	DIN 51524
Flame resistant without water	FKM, FVMQ	HFDU, HFDR	ISO 12922
Flame resistant with water	NBR low temp.	HFA-E, HFA-S, HFB, HFC	

Fluid viscosity: 15 ÷ 100 mm²/s - max allowed range 2,8 ÷ 500 mm²/s
min = 0,9 mm²/s for X full stainless steel execution with pure water

**CAUTION: easily inflammable hydraulic fluid**

In connection with fire or other hot sources, leaking hydraulic fluid may lead to fire or explosions.

10.8 Filtration

The correct fluid filtration ensures a long service life of the valves and it prevents anomalous wearing or sticking



Contamination in the hydraulic fluid may cause functional failures e.g. jamming or blocking of the valve spool / poppet. In the worst case, this may result in unexpected system movements and thus constitute a risk of injury.

Ensure adequate hydraulic fluid cleanliness according to the cleanliness classes of the valve over the entire operating range.

Max fluid contamination level: ISO 4406 class 20/18/15 NAS 1638 class 9

Note: see also filter section at www.atos.comm or KTF catalog

10.9 Valve fastening

- for all directional valves and LIMMX(S) functional cover

Remove the protection pad located on the valve mounting surface.

Check the correct positioning of the seals on the valve ports.

Verify that the valve mounting surface is clean and free from damages and burrs.

Lock the fastening bolts in cross sequence (like in aside example) at the tightening torque specified in the valve technical table.

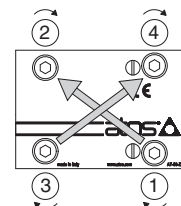

10.10 Tightening torque

- for screw-in pressure relief cartridges

Valve code	CART MX-3	CART MXS-3	CART MX-6	CART MXS-6	CART AREX-20	CART AREXS-20
	22		27		36	
Tightening torque (Nm)	60		55		140	

11 ELECTRICAL CONNECTIONS

- for ex-proof solenoid directional valves



The connection to the external circuit is made with a screw clamps 2 poles + ground, installed inside the solenoid.

Only for multicertified valves the eventual requirement of the additional ground connection on the solenoid housing must be made on the relative screw (M3x6 UNI-6107).

- The threaded cable entrance is provided with following connections:

- Cylindrical thread M20x1,5 UNI 4535 for Multicertified valves
- Conical thread 1/2" NPT ANSI B2.1 for cULus certified valves

The cable glands used for the cable entrance must be certified for the specific hazardous environment – see tech. table **KX800** for Atos ex-proof cable glands (only for multicertified valves).

Note: a Loctite sealant type 545, should be used on the cable gland entry threads

The electrical cables must be suitable for the working temperatures as shown in the section 11.1

Multicertification

cULus certification

① cover with threaded connection for vertical cable gland fitting
 ② cover with threaded connection for horizontal cable gland fitting
 ③ terminal board for cables wiring
 ④ standard manual override
 ⑤ screw terminal for additional equipotential grounding

① = Coil PCB 3 poles terminal board
 ② = GND suitable for wires cross sections
 ③ = Coil up to 2,5 mm² (max AWG14)

Pay attention to coil polarity

1 = Coil + PCB 3 poles terminal board suggested cable section up to 1,5 mm²
 2 = GND
 3 = Coil - (max AWG16)

alternative GND screw terminal connected to solenoid housing

11.1 Cable specification and temperature



Cable specification - Multicertification Group I and Group II

Power supply: section of coil connection wires = 2,5 mm²

Grounding: section of internal ground wire = 2,5 mm²
section of external ground wire = 4 mm²



Cable temperature - Multicertification Group I and Group II

Solenoid code	Max ambient temperature [°C]	Temperature class	Max surface temperature [°C]	Min cable temperature
OA(B)X OA(B)XS	45 °C	T6	85 °C	not prescribed
	70 °C	T4	135 °C	90 °C
OA(B)KX OA(B)KXS	45 °C	T4	85 °C	100 °C
	50 °C	T3	200 °C	100 °C
	60 °C	T3	200 °C	120 °C
	70 °C	T3	200 °C	130 °C



Cable specification - cULus certification

- Suitable for use in Class I Division 1, Gas Groups C
- Armored Marine Shipboard Cable which meets UL 1309
- Tinned Stranded Copper Conductors
- Bronze braided armor
- Overall impervious sheath over the armor

Any Listed (UBVZ/UBVZ7) Marine Shipboard Cable rated 300 V min, 15A min. 3C 2,5 mm² (14 AWG) having a suitable service temperature range of at least -40°C to +110°C

Note 1: For Class I wiring the 3C 1,5 mm² AWG 16 cable size is admitted only if a fuse lower than 10 A is connected to the load side of the solenoid wiring.



Cable temperature - cULus certification

Solenoid code	Max ambient temperature [°C]	Temperature class	Max surface temperature [°C]	Min cable temperature
OAX/EC OAXS/EC	55 °C	T6	85 °C	100 °C
	70 °C	T5	100 °C	100 °C
OAKX/EC OAKXS/EC	55 °C	T3	200 °C	115 °C
	70 °C	T3	200 °C	140 °C

10 MAINTENANCE



Maintenance must be carried out only by qualified personnel with a specific knowledge of hydraulics and electrohydraulics

10.1 Ordinary maintenance



Ex-proof solenoid must not be disassembled

For all stainless steel valves:

- The valves do not require other maintenance operations except seals replacement
- Results of maintenance and inspection must be planned and documented
- Follow the maintenance instructions of the fluid manufacturer
- Any preventive maintenance should be performed only by experienced personnel authorized by Atos.
- Cleaning the external surfaces using a wet cloth to avoid accumulation of dust layer over 5 mm
- Do not use compressed air for cleaning to avoid any dangerous dust dispersion on the surrounding atmosphere
- Any sudden increment in temperature requires the immediate stop of the system and the inspection of the relevant components

10.2 Repairing

In case of incorrect functioning or beak-down it is recommended to send the valve back to Atos or to Atos authorized service center, which will provide for the reparation.

If the reparations are not made by the manufacturer, they must be performed in accordance to the criteria of IEC 60079-19 standard for IECEx and EN 60079-19 for ATEX, and by facilities having the technical know-how about the protection modes and equipped with suitable tools for repairing and controls.



Service work performed on the ex-proof solenoid valve by end user or not qualified personnel invalidates the certification. Ex-proof solenoid must not be disassembled

Before beginning any repairing activity, the following guidelines must be observed:

- Unauthorized opening of the valves during the warranty period invalidates the warranty and invalidates the certification
- Be sure to use only original spare parts manufactured or supplied by Atos factory
- Provide all the required tools to make the repair operations safely and to don't damage the components
- Read and follow all the safety notes given in section [9](#)

11 TRANSPORT AND STORAGE

11.1 Transport

Observe the following guidelines for transportation of valves:

- Before any movement check the valve weight reported in the technical table relevant to the specific component
- Use soft lifting belts to move or lift the heavy valves to avoid damages



CAUTION

Danger of damage to property and personal injuries!

The valve may fall down and cause damage and injuries, if transported improperly:

- Use the original packaging for transport
- Use personal protective equipment (such as gloves, working shoes, safety goggles, working clothes, etc.)

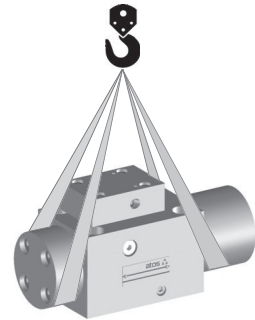

11.2 Storage

Stainless steel valves are made with selected materials offering the best protection against oxidization.

Additionally, they are boxed using a VpCi protective packing system, offering an increased protection during sea transport or long storage in humid environments, even if the stainless valves are already free from oxidation.

For the valves transporting and storing always observe the environmental conditions specified in the relevant technical tables. Improper storage may damage the product.

The valves can be stored for up to 12 months under the following conditions:

- If there is no specific information in the components technical tables, comply with a storage temperature of $-20\text{ }^{\circ}\text{C}$ to $+50\text{ }^{\circ}\text{C}$
- Stainless steel valves factory tested with pure water (code /W) must not be stored with ambient temperature lower than $5\text{ }^{\circ}\text{C}$
- Do not store the valves outdoors
- Protect the valves against water and humidity in case of storage in open air
- Store the valves in the shelf or on a pallet
- Store the valves in the original packaging or comparable packaging in order to protect them from dust and dirt
- Remove the plastic covers from the valves mounting surface only before the assembly

In case of storage period longer than 12 months please contact our technical office

12 RELATED DOCUMENTATION

Directional valves

- EW010** DHAX, DHAXS – ex-proof solenoid, direct, spool type
EW020 DLAHX, DLAHXS, DLAHMX, DLAHMXS – ex-proof solenoid, direct, poppet type
EW050 DLAHPX, DLAHPXS, DLAPX, DLAPXS - ex-proof solenoid, piloted, poppet type
EW100 DLHPX, DLHPXS, DLPX, DLPXS – hydraulic operated

Pressure relief valves

- CW010** CART MX, CART MXS, CART AREX, CART AREXS – direct, screw-in cartridges
DW010 HMPX, HMPXS – direct, modular
HW010 LIMMX, LIMMXS + SC LIX – piloted, ISO cartridges

Operating and maintenance information for stainless steel PED valves



safety pressure relief valves, conforming to PED Directive 2014/68/EU

This operating and maintenance information applies to Atos stainless steel safety pressure relief valves conforming to Pressure Equipment Directive (PED) 2014/68/EU. It is intended to provide useful guidelines on the safe and proper assembly, commissioning, operation, use, maintenance and transport of PED valves. The prescriptions included in this document must be strictly observed to avoid damages and injury.



1 SYMBOL CONVENTIONS

Following symbols are used in this documentation to evidence particular risks to be carefully avoided. In the following are listed the symbol conventions with their meaning, in case of non-compliance with this operating and maintenance information.

 WARNING	Death or serious injury could occur	risk classes to ANSI Z535.6 / ISO 3864
 CAUTION	Minor or moderate injury could occur	
NOTICE	Property damage could occur	
	Information to be observed	

2 GENERAL NOTES

This document is relevant to the installation, use and maintenance of on-off directional, flow and pressure control valves. It is intended for machine manufacturers, assemblers and system end-users.



WARNING
Personal injury and property damage may be caused by incorrect use of the products!

The products have been designed for use in industrial environments and may only be used in the appropriate way.

Before using Atos valves, the following requirements must be met to ensure the appropriate use of the products:

- personnel who uses Atos valves must first read and understand the operating and maintenance information, particularly the Safety Notes in section [6](#)
- the products must remain in their original state, no modifications are permitted
- damaged or faulty valves must not be installed or put into operation
- make sure that the products have been installed as described in section [7](#)

2.1 Warranty

The expiration of warranty results from the following operations:

- incorrect assembly and commissioning
- improper use, see [6.2](#)
- improper handling and storage, see [10](#)
- modification of the original condition

3 CERTIFICATION

Safety pressure relief valves are certified by DEKRA, according to Pressure Equipment Directive 2014/68/EU (PED).

They meet the requirements specified in: Module B - EU Type Examination - Production Type (Annex III) of Directive 2014/68/EU - PED category IV

4 COMPONENTS DESCRIPTION

This document applies to direct operated safety pressure relief valves type CART MX(S)-* and CART AREX(S). These valves are designed to operate as safety components, limiting the maximum system pressure or to protect parts of the circuit from overpressure.

They are also used as safety valves to protect hydraulic accumulators.

The valves are factory set at the pressure level required by the customer.

The pressure adjustment screw of the valves is protected with a lead sealed plastic cap to avoid manumission of the factory setting.



Any tampering of the lead sealing invalidates the certification.

5 PRODUCT IDENTIFICATION EXAMPLES - nameplates

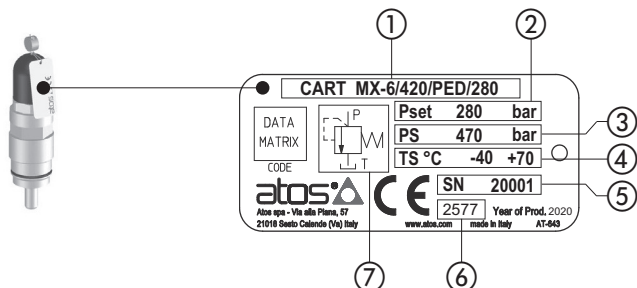

- ① Valve code
- ② Factory pressure setting
- ③ Burst pressure
- ④ Min ÷ Max fluid or ambient temperature range
- ⑤ Valve serial number (1)
- ⑥ Notified body reference number
- ⑦ Hydraulic symbol

(1) Example for serial number:

20	-	001
Year: 20 = 202		Progressive number

Note: nameplates may not be painted but must be kept in a readable condition

6 SAFETY NOTES

6.1 Intended use

Atos valves are intended for integration in industrial systems and machines or for the assembly with other components to form a machine or a system. They may only be operated under the environmental and operating conditions described in the valves technical tables.

6.2 Improper use

Any improper use of the components is not admissible.

Improper use of the product includes:

- Wrong installation
- Use of inappropriate or non-admissible hydraulic fluids
- Use outside of specified performance limits
- Use outside the specified temperature range
- The safety valves must not be used if the maximum system flow exceeds the value indicated as "max admissible" reported in the relevant technical table
- Manumission of the factory pressure setting
- Incorrect transport

6.3 Installation

Installation must be performed following the recommendations contained in the valves technical tables



Any tampering of the lead sealing invalidates the certification.



CAUTION

Use of the valve outside the approved temperature range may lead to functional failures.

Only use the valve within the specified ambient and fluid temperature range.



CAUTION: pressurized systems

When working at hydraulic systems with stored energy (accumulator or cylinders working under gravity), valves may even be pressurized after the hydraulic power supply has been switched off.

During assembly and disassembly works, serious injury may be caused by a powerful leaking of hydraulic fluid jet.

Ensure that the whole hydraulic system is depressurized, and the electrical control is de-energized.

NOTICE: dirt and foreign particles

Penetrating dirt and foreign particles lead to wear and malfunctions of the valves.

During assembly, be careful to prevent foreign particles such as metal chips getting into the valve or into the hydraulic system

Do not use linting fabric for the valve cleaning.



Environmental protection

Hydraulic fluids are harmful to the environment.

Leaking hydraulic fluid may lead to environmental pollution.

In case of fluid leakage immediately act to contain the problem.

Dispose of the hydraulic fluid in accordance with the currently applicable national regulations in your country.

Atos components do not contain substances hazardous for the environment.

The materials contained in Atos components are mainly: Copper, Steel, Aluminium, Electronic components, Rubber

Due to the high content of reusable metals, the main components of Atos can be completely recycled after disassembling of the relevant parts.

7 HYDRAULIC AND MECHANICAL INSTALLATION

Safety pressure relief valves must be used as supplied by Atos, without unduly opening, division and/or substitution of internal parts.

Oil direction: P→T

Inlet oil port: P

Outlet oil port: T

Pressure on the discharge line T must be close to zero.

Verify that the seals are in good conditions before install the valves in the system.

The valves, must not be removed from their manifold after commissioning, in order to avoid the loosening of internal parts.

The end user must provide proper systems to avoid the cartridge disassembling.

See also section 7.1 for tightening torque.

7.1 Tightening torque

Valve code	CART MX-3	CART MXS-3	CART MX-6	CART MXS-6	CART AREX-20	CART AREXS-20
	22		27		36	
Tightening torque (Nm)	60		55		140	

7.2 Hydraulic fluids and operating viscosity range

The hydraulic fluids must be compatible with the selected seals.

Make sure that the working fluid is compatible with gas and dust present in the environment.

The type of fluid has to be selected in consideration of the effective working temperature range, so that the fluid viscosity remains at the optimal level.

Hydraulic fluid	Suitable seals type	Classification	Ref. Standard
Mineral oils	NBR low temp., FKM	HL, HLP, HLPD, HVL, HVLDP	DIN 51524
Flame resistant without water	FKM, FVMQ	HFDR, HFDR	ISO 12922
Flame resistant with water	NBR low temp.	HFA-E, HFA-S, HFB, HFC	

Fluid viscosity: 15 ÷ 100 mm²/s - max allowed range 2,8 ÷ 500 mm²/s
min = 0,9 mm²/s for X full stainless steel execution with pure water

7.3 Filtration

The correct fluid filtration ensures a long service life of the valves and it prevent anomalous wearing or sticking.



Contamination in the hydraulic fluid may cause functional failures e.g. jamming or blocking of the valve spool / poppet.

In the worst case, this may result in unexpected system movements and thus constitute a risk of injury.

Ensure adequate hydraulic fluid cleanliness according to the cleanliness classes of the valve over the entire operating range.

Max fluid contamination level:

ISO 4406 class 20/18/15 NAS 1638 class 9

Note: see also filter section at www.atos.com or KTF catalog

8 MAINTENANCE



Maintenance must be carried out only by qualified personnel with a specific knowledge of hydraulics and electrohydraulics

8.1 Ordinary maintenance

Safety pressure relief valves do not require specific maintenance.

A visual inspection is definitely useful to check the integrity of lead sealing and the absence of external oil leakages.

Periodically the external surface of the valve should be cleaned from dirt to allow a clear readability of the identification plate.

8.2 Repairing

Safety pressure relief valves are supplied as single assembled unit: spare parts are not allowed.

In case of incorrect functioning or beak-down it is recommended to send the valve back to Atos or to Atos authorized service center which will provide for the reparation.

9 CERTIFIED DISCHARGE COEFFICIENT Kdr - only for valves CART MX(S)-3 and CART MX(S)-6

CART MX-3/420/PED and CART MXS-3/420/PED - minimum calibration flow: Q =0.5 l/min

Pset [bar] (1)	Qmax [l/min] (2)	Kdr (3)	Pmax [bar] (4)
25 - 50	1,2 - 1,2	0,18	55
51 - 100	1,2 - 1,35	0,18	110
101 - 150	1,6 - 1,6	0,12	165
151 - 210	2 - 2,5	0,18	231
211 - 350	2,1 - 2,5	0,41	385
351 - 420	2,5 - 2,5	0,39	462

CART MX-6/420/PED and CART MXS-6/420/PED - minimum calibration flow: Q =2 l/min

Pset [bar] (1)	Qmax [l/min] (2)	Kdr (3)	Pmax [bar] (4)
25 - 50	8 - 34	0,71	55
51 - 100	34 - 60	0,89	110
101 - 150	60 - 60	0,57	231
151 - 210	60 - 60	0,58	308
211 - 350	60 - 60	0,39	385
351 - 420	60 - 60	0,58	462

Notes:

- (1) Pset: factory pressure setting at the indicated minimum flow (Q)
- (2) Qmax: max flow rate reached at Pset + 10%
- (3) Kdr: Certified discharge coefficient. It represents the ratio between the actual flow that is discharged by the valve and the theoretical flow calculated on the basis of the passage section and the Δp .
- (4) Pmax: pressure reached at Qmax (with limit of Pset + 10%)

10 STORAGE

10.1 Storage

Stainless steel valves are made with selected materials offering the best protection against oxidization. Additionally, valves are boxed using a VpCi protective packing system, offering an increased protection during sea transport or long storage in humid environments even if the stainless valves are already free from oxidation.

For the valves transporting and storing always observe the environmental conditions specified in the relevant technical tables. Improper storage may damage the product.

The valves can be stored for up to 12 months under the following conditions:

- If there is no specific information in the components technical tables, comply with a storage temperature of $-20\text{ }^{\circ}\text{C}$ to $+50\text{ }^{\circ}\text{C}$
- Stainless steel valves factory tested with pure water (code /W) must not be stored with ambient temperature lower than $5\text{ }^{\circ}\text{C}$
- Do not store the valves outdoors
- Protect the valves against water and humidity in case of storage in open air
- Store the valves in the shelf or on a pallet
- Store the valves in the original packaging or comparable packaging in order to protect them from dust and dirt
- Remove the plastic covers from the valves mounting surface only before the assembly

In case of storage period longer than 12 months please contact our technical office

11 RELATED DOCUMENTATION

Pressure relief valves

CWY010 CART MX*/PED, CART MXS*/PED, CART AREX*/PED. CART AREXS*/PED – direct, screw-in safety cartridges with PED certification

Operating and maintenance information for stainless steel cylinders

These operating and maintenance information are valid only for Atos hydraulic cylinders and are intended to provide useful guidelines to avoid risks when hydraulic cylinders are installed in a machine or a system. Information and notes on the transport and storage of hydraulic cylinders are also provided.

These norms must be strictly observed to avoid damages and ensure trouble-free operation. The respect of these operating and maintenance information ensures an increased working life and thus reduced repairing cost of the hydraulic cylinders and system.

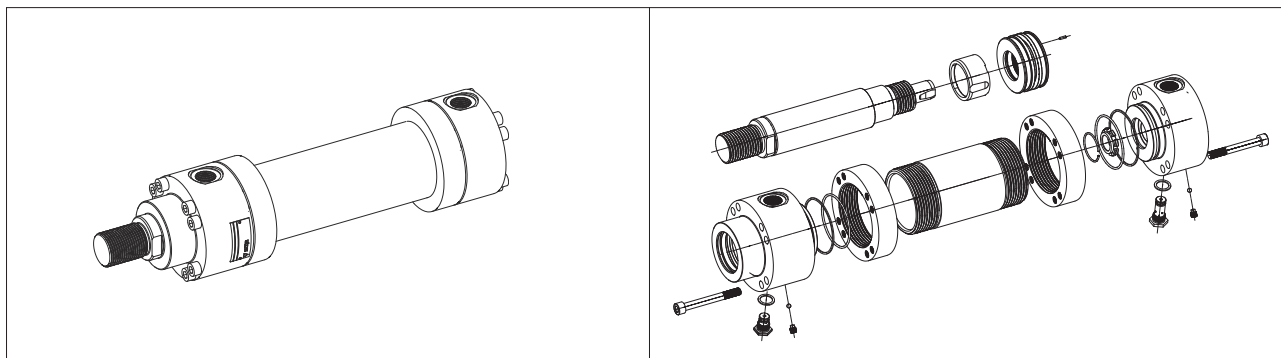

1 SYMBOL CONVENTIONS

Following symbols are used in this documentation to evidence particular risks to be carefully avoided.

In the following are listed the symbol conventions with their meaning, in case of non-compliance with this operating and maintenance information.

	CAUTION	Minor or moderate injury could occur	risk classes to ANSI Z535.6 / ISO 3864
		Information to be observed	

2 GENERAL NOTES

The cylinder operating and maintenance information are part of the operating instructions for the complete machine but they cannot replace them

Atos is not liable for damages resulting from an incorrect observance of these instructions.

All the hydraulic cylinders have 1 year warranty; the expiration of warranty results from the following operations:

- Unauthorised mechanical or electronic interventions
- The hydraulic cylinders are not used exclusively for their intended purpose as defined in these operating and maintenance instructions

3 WORKING CONDITIONS



CAUTION

The operation of hydraulic cylinders is not permitted at different operating and environmental conditions than those specified below

Description	CNX
Ambient temperature	-20 ÷ +120°C
Fluid temperature	-20 ÷ +120°C
Max surface temperature	-
Max working pressure	10 MPa (100 bar)
Max pressure	15 MPa (150 bar)
Max frequency	5 Hz
Max speed	4 m/s
Recommended viscosity	15 ÷ 100 mm ² /s
Max fluid contamination level	ISO4406 20/18/15 NAS1638 class 9, see also filter section at www.atos.com or KTF catalog

4 NAMEPLATES

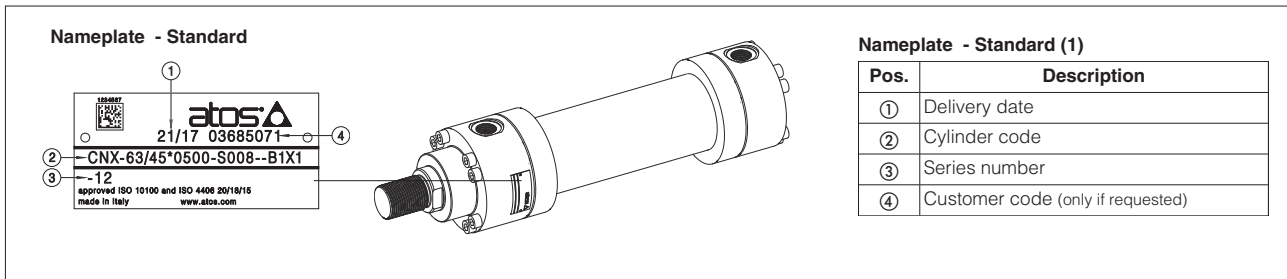

Notes: (1) The position of the nameplate on the rear or front heads can change due to the cylinder overall dimensions

5 SAFETY NOTES

5.1 General

- The presence of cushioning can lead to a peak of pressure that can reduce the cylinder working life, ensure that the dissipated energy is less than the max value reported in **tab. B015**
- Make sure that the maximum working conditions, shown in section 3, are not exceeded
- Ensure to use hydraulic fluids compatible with the selected sealing system, see **tab. BW500**
- The rod must be handled with care to prevent damages on the surface coating which can deteriorate the sealing system and lead to the corrosion of the basic material
- The mounting screws must be free from shearing stress
- Transverse forces on the rods must always be avoided
- When the cylinder has to drive a rotating structure or where little alignment errors are expected, mounting style with spherical bearing should be used
- Contact surfaces, support elements in tolerance, elastic materials and labels must be covered before painting the cylinder

5.2 Position measuring system

- Position transducers must never be removed, if not otherwise specified in **tab. B310**, while the cylinder is under pressure
- Observe the information provided in **tab. B310** for the electronic connections
- The connectors must never be plugged or unplugged when the power supply is switched-on

5.3 Installation

- Consult **tab. P002** for installation, commissioning and maintenance of electrohydraulic system
- The piping have to be dimensioned according to the max pressure and max flow rate required
- All pipes and surfaces must be cleaned from dirt before mounting
- Remove all plug screws and covers before mounting
- Make sure that connections are sealed before giving pressure to the system
- Ensure to not exchange the pipe ports when connecting the cylinders
- Bleed-off the system or the hydraulic cylinder using the proper device, see the technical data sheet for details
- Ensure that the cylinder mounting allow easy of acces for the purpose of maintenance and the adjustment of cushioning

6 MAINTENANCE



Maintenance must be carried out only by qualified personnel with a specific knowledge of hydraulics and electrohydraulics

6.1 Preliminary check and ordinary maintenance

Atos hydraulic cylinders don't require any maintenance after commissioning. Anyway it is recommended to take into account the following remarks:

- Results of maintenance and inspection must be planned and documented
- Check oil escaping from oil ports or leakages at the cylinder heads
- Check for damages of the chromeplated surface of the rod: damages may indicate oil contamination or the presence of excessive transverse load
- Determine lubricating intervals for spherical clevises, trunnion and all parts not self-lubricated
- The rod should always be retracted during long stop of the machine or system
- Remove any salt, machining residuals or other dirt cumulated on the rod surface
- Follow the maintenance instructions of the fluid manufacturer

6.2 Repairing

Before beginning any repairing observe the following guidelines:

- Unauthorized opening of the cylinder during the warranty period results in the warranty expiration
- Be sure to use only original spare parts manufactured or supplied by Atos
- Provide all the required tools to make the repair operations safely and not damage the components
- Read and follow all the safety notes given in section 5
- Ensure that the cylinder is well locked before beginning any operation
- Disassembly or assembly the cylinder with the right order as indicated in section 6.3
- When mounting rod or piston guides and seals observe the correct position as indicated in section 6.4. Any bad positioning can result in oil leakages
- It is strongly recommended the use of expanding sleeves to insert the seals in the proper groove
- Tighten all the screws or nuts as follow: lubricates the threads, insert the screw or the nut by hand for some turns, tighten the screw crosswise with the tightening torque specified in the technical table (a pneumatic screw driver may be used)
- Rod bearing and piston must be locked respectively to the front head and to the rod by means of special pin to avoid unscrewing
- The replacement of wear parts such as seals, rod bearing and guide rings depends on the operating conditions, temperature and quality of the fluid

6.3 Cylinders exploded views

CNX - For spare parts contact our technical office

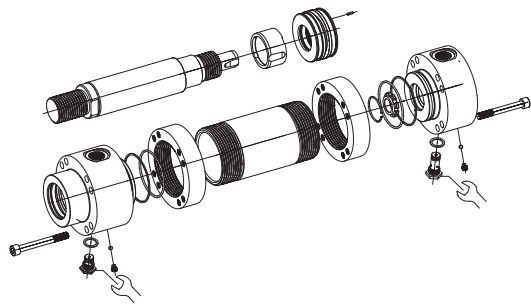

CNX* - For spare parts contact our technical office

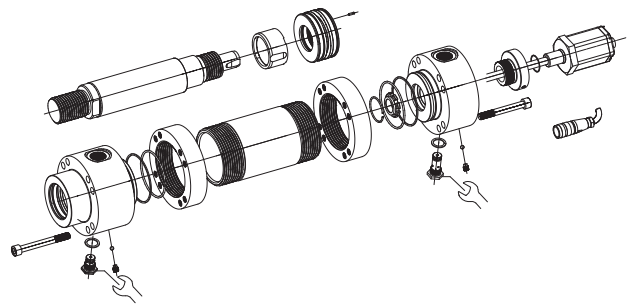

Note:  this symbol means that a particular equipment is required for mounting, contact our technical office

6.4 Sealing system mounting

PISTON

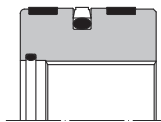

G3-G5-G8

ROD BEARING

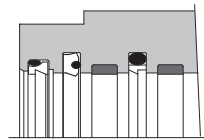

G8

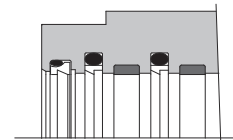

G3-G5

7 TRANSPORT AND STORAGE

7.1 Transport

Observe the following guidelines for transport of hydraulic cylinders:

- Cylinders have to be transported using a forklift truck or a lifting gear always ensuring a stable position of the cylinder
- Cylinders have to be transported in horizontal position in their original packaging
- Use soft lifting belts to move or lift the cylinders in order to avoid damages
- Before any movement check the cylinders weight (due to tolerances, the weight may be 10% greater than the values specified in the technical table)



CAUTION

Additional parts such as pipes, subplates and transducers must never be used for lifting

7.2 Storage

Stainless steel cylinders are made with selected materials offering the best protection against oxidation. Additionally all cylinders are tested with mineral oil OSO 46; the oil film, presents in the cylinder chambers after testing, ensures the internal corrosion protection.

Anyway be care to observe the following remarks:

- When a storage in the open air is foreseen ensure that cylinders are well protected against water
- The cylinders must be inspected at least once a year and rotated through 90° every six months to preserve the seals



In case of storage period longer than 12 months, contact our technical office

8 CYLINDERS TROUBLESHOOTING

TROUBLE	POSSIBLE CAUSES	SOLUTIONS
Oil leakage	High lateral loads involve a premature wear of the bronze bushing, seals and wear rings	a) Improve the precision of the machine alignment b) Decrease lateral loads c) Install a pivoted mounting style D-S-L
	Fluid contaminants produce scratch and score marks on the seals	Check the fluid contamination class is < 20/18/15
	Chemical attack cause the deterioration of seals compound	Check seals compatibility with operating fluid
	High temperatures (fluid/ambient) the seals dark and flaked	a) Decrease the fluid temperature b) Install G3 sealings for high temperatures
	Low temperature (ambient) make the seals brittle	Move the cylinder in a higher temperature zone
	High rod speed reduce the lubricant capacity of the seals	For rod speed > 5 m/s Install G3-G5 seals
	Output rod speed higher than the input one	Check the rod speed ratio in/out complies with the minimum R_{min} value, see tech.table B015
	The pressurization of the mixture air/mineral oil may involve self combustion dangerous for the seals (Diesel effect)	Bleed off completely the air inside the hydraulic circuit
Wiper or seal extrusion	Overpressure	a) Limit the pressure of the system b) Install G3-G5 seals if overpressure cannot be reduced
	Rod seals leakages may involve overpressures among wiper and rod seal, causing their extrusion	See possible causes and solutions for oil leakage troubles
Lose of cushioning effect	Rod speed too low at end stroke	Check the cushioning adjustment is not fully open, regulate it if necessary
	Cushioning adjustment cartridge with improper regulation	Close the cushioning adjustment screw till restoring the cushioning effect
	Fluid contaminants produce scratch and score marks on the cushioning piston	Check the fluid contamination class is < 20/18/15
Rod locked or impossible to move	Overpressure in the cushioning chamber could involve the cushioning piston locking	a) Replace "fixed" cushioning 7-9 with "adjustable" cushioning 1-3 b) For adjustable cushioning, open the cushioning adjustment to decrease the max pressure inside the cushioning chamber c) Check the energy dissipated by the cushioning is lower than max energy dissipable, see tech.table B015
	Fluid contaminants may lock the piston because of its tight tolerances	Check the fluid contamination class is < 20/18/15
Rod failure	Overload/overpressure involves ductile rod failure	a) Check the overpressure inside the cylinder and decrease it b) Check the compliance with the admitted operating pressure according to the cylinder series
	High load/pressure coupled to high frequencies or long life expectation involves fatigue rod failure	a) Check the expected rod fatigue working life proposed in tech. table B015 b) Decrease the operating pressure
Rod vibration	Seals with excessive friction could involve rod vibration and noise	Install low friction PTFE seals G3-G5
	Air in the circuit may involve a jerky motion of the rod	Bleed off completely the air inside the hydraulic circuit
Rod motion without oil pressure	Variations in the fluid temperature involve the fluid expansion / compression thus the rod moving	a) Decrease the temperature variations in the oil b) Change the fluid type to decrease the coefficient of thermal expansion
	Excessive oil leakage from the piston or rod seals	See likely causes and solutions for oil leakage troubles
Noisy cylinder	Impact of the piston with the heads caused by high speed (>0,05 m/s)	a) Decrease the rod speed b) Install external or internal cushioning system 1-9 , see tech.table B015 for the max energy that can be dissipated
	Fluid contaminants, foreign particles inside the cylinder may generate unusual noise	Check the fluid contamination class is < 20/18/15
	High oil flow speed > 6 m/s	Increase the piping diameters to reduce the oil flow speed

9 SERVOCYLINDERS TROUBLESHOOTING

TROUBLE	POSSIBLE CAUSES	SOLUTIONS
Transducer malfunctioning / failure	Improper electronic connections may involve the transducer malfunctioning	Check the electronic connections scheme in tech table B310
	Not stabilized power supply may involve dangerous peak of voltage	Install a voltage stabilizer
	Uncontrolled disconnection and connection of plug-in connectors may damage the transducer	Be careful to switch off the power supply before connecting the position transducer

Note: for cylinders troubleshooting refer to section [8](#)



Headquarters
Italy - 21018 Sesto Calende
Phone +39 0331 922078
info@atos.com

Worldwide Sales Organization

Branches

Argentina - Benelux - Brazil - Canada - China - Czech Republic
Denmark - Finland - France - Germany - Great Britain
India - Korea - Poland - Romania - Russia - Singapore
Spain - Sweden - Taiwan - Thailand - Turkey - USA

Agents and service

Algeria - Australia - Austria - Belgium - Bulgaria - Chile - Colombia
Croatia - Cyprus - Ecuador - Egypt - Greece - Hong Kong - Hungary
Iceland - Indonesia - Iran - Ireland - Israel - Japan - Jordan
Kazakhstan - Latvia - Lithuania - Malaysia - Mexico - Morocco
Netherlands - New Zealand - Norway - Pakistan - Paraguay - Peru
Philippines - Portugal - Saudi Arabia - Slovenia - South Africa
Switzerland - Syria - Tunisia - Ukraine - United Arab Emirates
Uruguay - Venezuela - Vietnam



www.atos.com

FLUID POWER SOLUTIONS[®]

Find a location near you!



Mi Fluid Power Solutions

Looking for specialized solutions for fluid power operations? Talk to the experts at Mi Fluid Power Solutions for expertise related to hydraulic power units, gearbox, and cylinder repair.

To view locations, scan QR Code or go to: qrco.de/bd4Ofp



© 2022 Motion

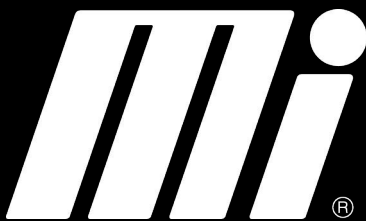

MORE CHOICES. MORE INVENTORY. MORE EXPERTISE.